



RK1902S massage chair

Maintenance instructions

Rong Kang massage chair service is fast and excellent.



Shandong kangtai industry co., ltd



Qianyan

Thank you for choosing to use Rong Kang massage chair!

It is our greatest honor to be a user of Shandong Kangtai Industrial Co., Ltd. I sincerely hope that Rong Kang massage chair can be a good helper for your leisure and health care.

In order to facilitate dealers and customer service personnel to do a good job in on-site maintenance of products, this paper summarizes and sorts out some common problems and fault solutions in the use of massage chairs for professional maintenance personnel to refer to.

Note: Non-professionals, please do not try.

<http://www.kangtaigroup.com>

Shandong kangtai industry co., ltd



catalogue

- 1. Composition of product structure 4
 - (1). RK1902S Structure Diagram 4
- 2. Fault phenomenon and solution 6
 - (1). The whole machine of the massage chair does not work and the hand controller does not display 6
 - (2). Lifting motor and leg support do not work, and other functions are normal 6
 - (3). The massage machine goes up and down abnormally 6
 - (4). The massage machine kneads abnormally 7
 - (☒). The massage machine taps abnormally 8
 - (6). Abnormal forward tilt of the massage machine 8
 - (7) The whole machine is not inflated or a certain road is not inflated. The massage machine works normally 9
 - (8). The pole does not move 10
 - (9). The screen of the hand controller is abnormal, and the key operation function is normal. 10
 - (10). Foot rollers do not work 11
- 3. Mechanical failures and solutions 12
 - (1). Replacing the massager 12
 - (2). Replacing the solenoid valve 13
 - (3). Replace the air pump 14
 - (4). Replacing the leg electric strut 14
 - (☒). Replacing electric backrest struts 15
 - (6). Replacing the sole roller 16
 - (7). Replacing the handrail light board 18
 - (8). Replacing the shoulder light belt 19
- 4. Wiring diagram of the main circuit board port 21
 - ☒、 Main circuit board component layout diagram 22
- 6. System connection diagram 23
- 7. Power-on sequence and voltage distribution 24

I. Product components:

(1) RK1902S structure diagram

准备工作

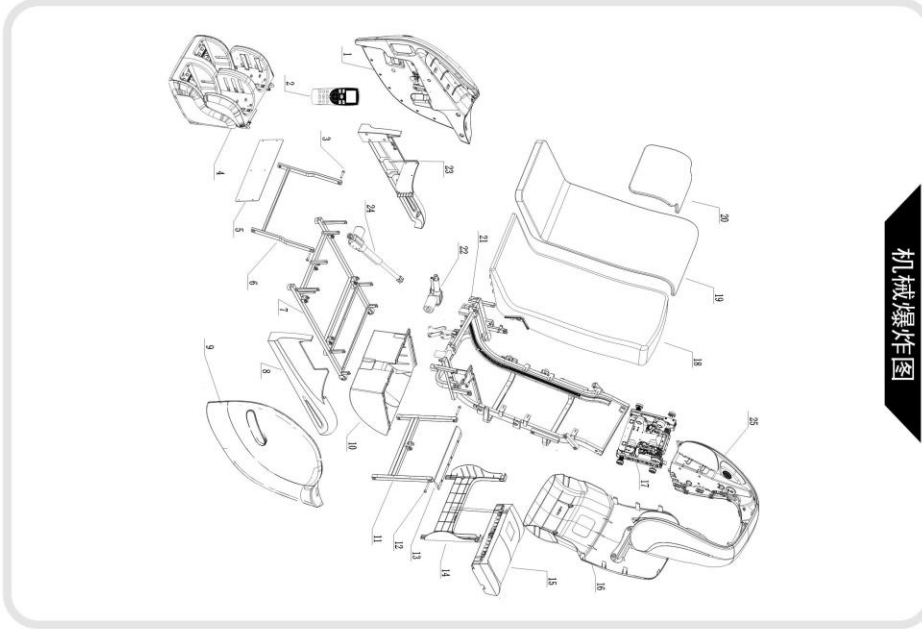

准备工作

7

机械组件图

机械爆炸图

序号	名称	数量	序号	名称	数量
1	右扶手总成	1	22	电动撑杆210-310	1
2	手控器总成	1	23	底座侧挡板-右	1
3	靠背螺栓	2	24	电动撑杆310-160	1
4	腿部部总成	1	25	肩部总成	1
5	前下挡板	1			
6	前摆杆组件	1			
7	底座总成	1			
8	底座侧挡板-左	1			
9	左扶手总成	1			
10	前保护罩	1			
11	后摆杆组件	1			
12	靠背螺栓	1			
13	后挡板2	1			
14	后挡板1	1			
15	电控箱总成	1			
16	靠背后盖	1			
17	机芯	1			
18	靠背	1			
19	背垫	1			
20	枕垫	1			
21	靠背架总成	1			

8

机械组件明细表

机械组件明细表

(II) Introduction of key component

Main circuit board,



power board, manual



control board



Safety/switch assembly power filter ring transformer

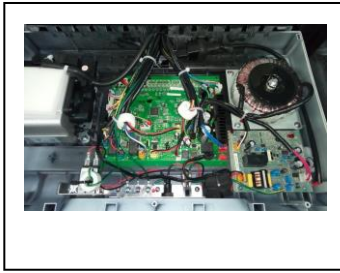

Brace control box assembly



hand controller assembly

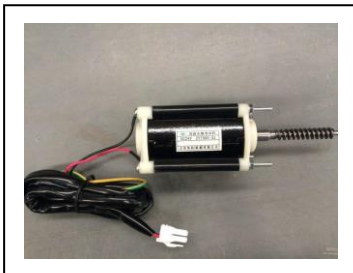

Foot roller motor

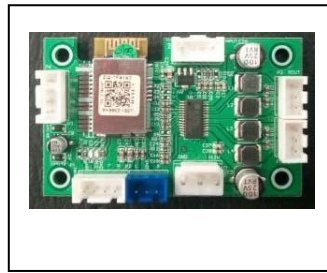

Bluetooth power amplifier



massage machine assembly



II. Common faults and solutions

1. The whole massage chair does not work, and the hand controller does not display.

1. 1 First, check that the socket is powered on and the switch is turned on to determine whether the fuse is blown. If the fuse is burned and replaced, it is normal.

1. 2 Measure the voltage of transformer white Sanxin connector (AC220V) and (AC20.5V) with multimeter AC voltage file. If AC220V voltage is normal, if there is no voltage, the ring transformer will be broken, and it will be normal after replacement.

1. 3 Measure whether the voltage (DC5V) between CN27 of the main board and the ground is normal with the multimeter DC voltage file. If there is no voltage, check whether the connecting line between the power board and the main board is in good contact. If there is no problem, it should be that the power board is broken and normal after replacement.

1. 4 Determine whether there is poor contact between the connector of the hand controller.

2. The lifting motor and leg brace do not work, other functions are normal, and the manual controller displays.

2. 1 Measure whether the voltage (DC12V) between ③ and the ground is normal with the multimeter DC voltage file. If there is no voltage, the main board is broken (LM1 LM2576T-12 should be checked generally), and it is normal after replacement.

3. Abnormal lifting of massage machine

3. 1 Determine whether there is a problem with the circuit drive.

Turn on the hand controller to make it work up and down, put the multimeter in the DC position, and measure whether the voltage at both ends of the connector at ⑥ is normal. If there is no voltage, the motherboard is broken, and it is normal after replacement.

3. 2 Top or bottom punching of massage machine

Turn on the hand controller to make it work in the up-down state. If the phenomenon of top or bottom flushing occurs, the limit signal of the lifting motor will fail (J3 green line is the lower limit signal and J4 yellow line is the upper limit signal). First, check whether the connector has fallen off, and then check whether the magnetic steel has fallen off. If the lifting motor is in the limit position, measure the limit signal level with a multimeter; if so, the main board will fail; if not, the limit board will fail. If the motor is not in the limit position, magnetic steel



can be used to repeat the above tests near the limit plate. If there is no change of high and low level, the main board will fail; if there is no change of level, the lifting limit plate will fail.

3.3 Up and down counting fault

If the local massage function is turned on, the massage machine will not work in a certain range, and the massage position indication of the hand controller is abnormal during the whole operation, which should be the failure of the lifting counting signal (J1 purple line is the lifting counting signal). First, check whether the connector has fallen off, then pry off the black counter on the side of the lifting motor, switch back and forth with the magnetic steel NS pole to be close to the black counter, and measure the counting signal at the same time. If there is a level change, the main board will be broken. If there is no change, the counter is bad.

3.4 Motor failure

If the motherboard voltage is normal, check whether there is any fault in the lifting motor (normal resistance value is 5-30 Ω).

3.5 Shoulder height detection fault

After starting a program, the massage machine starts shoulder height detection. If the massage machine goes directly to the upper limit position, it means that the shoulder height detection is faulty.

Measure the voltage between the second pin of J1 connector and the ground with a multimeter, and manually break off the left rocker arm of the massage machine to see if the voltage changes. If there is any explanation, the shoulder height detection infrared alignment tube is not broken, so just replace the motherboard.

If there is no change, it means that there is something wrong with the detection signal. Check whether the cable with the wide, medium and narrow detection board has connectors falling off or poor contact, and then check whether the connectors of the circuit board fall off and plug firmly. If there is no problem above, the shoulder height detection sensor is broken. Replace the shoulder height detection assembly.

4. Abnormal kneading of massage machine

4.1 Judging the driving failure

Turn on the hand controller to make it work in kneading state, put the multimeter in the DC voltage range to measure whether the voltage at both ends of the connector at ⑦ is normal, if there is no voltage, the motherboard is broken, and it is normal after replacement;

4.2 Judging motor failure



If there is voltage on the main board, the kneading motor (normal resistance of 5-30Ω) fails, and it is normal after replacement. 5. The tapping of the massage machine is abnormal.

5. 1 Drive circuit failure

Turn on the hand controller to make it work in tapping state, and put the multimeter in DC voltage range to measure whether the voltage at both ends of the connector is normal. If there is no voltage, the motherboard is broken, and it is normal after replacement.

5. 2 Kneading counting failure

Turn on the hand controller to make it work in the tapping state. If the massage machine keeps kneading, the width adjustment signal will be out of order (J2 green, yellow and white corresponds to wide, medium and narrow signal). Check whether the connector falls off and whether the width adjustment sensor has high and low level changes. If there is no level change, replace the width adjustment sensor.

5. 3 Judging motor failure

If the motherboard voltage is normal, check whether the tapping motor is faulty (normal resistance value is 5-30Ω). 6. Abnormal forward tilting of massage machine

6. 1 Drive circuit failure

Turn on the hand controller and choose a function casually, and the massage machine will automatically detect the shoulder height. When the massage machine goes to the waist position, it will lean forward. Put the multimeter in the DC voltage range to measure whether the voltage at both ends of the connector is normal. If there is no voltage, the motherboard will be broken, and it will be normal after replacement.

6. 2 Judging motor failure

If the motherboard voltage is normal, check whether the tapping motor is faulty (normal resistance value is 5-30Ω).

6. 3 Forward-leaning limit fault

If the massage machine leans forward and crosses the front or the back, the machine will make hard limit; Or when you lean forward, you always come to reverberate; Or when the machine is turned on for shoulder height detection, the massage machine always stays at the waist

position; Then forward-tilting limit failure (J1 pink orange line corresponds to front and rear limit signals), first check whether the connector falls off, whether the magnetic steel falls off or not, and whether the screws are loose, which causes the distance between the magnetic steel and the board to become larger, and then use a multimeter to test whether there is any change in the limit signal level, if there is any change, the motherboard or wire harness is broken, otherwise, the 3D forward-tilting limit board is broken.

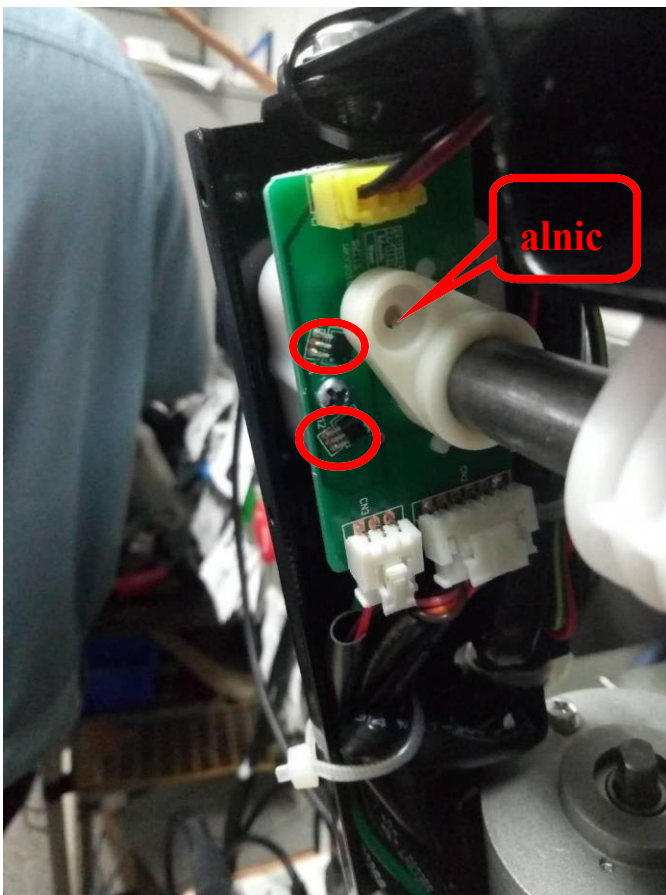

6. 4 Forward counting fault

If the program is turned on for the first time for shoulder height detection, when the massage machine goes to the waist position, it directly leans forward to the maximum; Or during the massage process, the forward tilting position of the massage machine is not adjusted; Then the forward lean count (J1 gray line is the forward lean count signal) fails. First, check whether the connector falls off, then pry off the black counter on the side of the forward tilting motor, and switch the magnetic steel NS pole back and forth to be close to the black counter, and measure the counting signal at the same time. If there is a level change, the motherboard or wire harness will be damaged; If there is no change, the counter is bad.

7. The whole machine is not inflated or one way is not inflated, and the massage machine works normally.



7. 1 Determine the air pump drive failure.

If the whole machine is not inflated, measure whether the black connector of the motherboard PCON1 PUMP has a voltage of about AC20.5V with the AC voltage shift of multimeter after starting the machine. If so, the air pump may be broken, and if there is no voltage output, the motherboard will be broken.

7. 2 None of the above are bad. Check whether the trachea falls off.

7. 3 One road fault

If a certain path is not inflated, measure whether the corresponding port of this path has a DC24V voltage output with a multimeter DC voltage scale, or shut down, and measure whether the corresponding solenoid valve of this path has a resistance value (resistance value is 165 (10%) ω) with a multimeter ohm scale.

8. 1 Determine whether the motherboard is damaged or the electric strut is damaged.

1. 1 The inoperative electric strut plug-in is exchanged with another electric strut plug-in (led out from the motherboard) and still does not work after the exchange, which proves that the electric strut has been damaged, and the fault can be eliminated by replacing it.

1. 2 After replacing the electric strut, it can work, which proves that the motherboard is damaged, and the fault can be eliminated by replacing the motherboard.

8. 2 Determine whether there is a problem with the circuit drive.

Put the multimeter in DC voltage range, insert two probes into the blue connector terminal at ⑨ shown in the figure, and operate the lifting button of the backrest of the hand controller to observe whether the multimeter has DC24V output; ⑩ In the green connector terminal, operate the lifting button of the backrest of the manual controller, and observe whether the multimeter has DC24V output. If there is a brace bar failure, if there is no motherboard failure, it will be normal after replacement.

8. 3 Determine whether there is a problem with the electric strut.

Unplug the strut connector, and check the resistance between the two wires of the strut. If the strut is measured at the upper and lower limits with diode gear, the positive and negative tests show that one-way conduction is good, otherwise the strut is bad. If the strut is in the middle position, measure it with multimeter resistance, and 5-30 Ω is normal. Other conditions prove that the electric strut motor is broken, and the fault can be eliminated by replacing the electric strut.

9. The screen of the hand controller is abnormal, and the key operation function is normal.

9. 1 The screen display is abnormal, and the key operation function is normal. Generally, the display screen of the manual control panel is faulty, which is normal after replacing the manual control assembly.



10. Foot roller does not work.

10. 1 Turn on the function of the sole roller, it doesn't work, put the multimeter in the DC voltage range,
and insert the two probes into the illustration (11).

Within the connector terminal, whether the output voltage is normal or not, if there is no voltage, the main board is broken, and if there is voltage output, the roller motor is generally broken.

III. Mechanical failures and solutions: 1. Replace the massage machine.

1. 1 Remove the rear guard.

Remove the four screws that fix the rear shield with a Phillips screwdriver, and take off the rear shield.

1. 2 Remove the connecting plate

Use a Phillips screwdriver to remove 3 screws on the left and right sides of the fixed connecting plate, and take off the connecting plate.

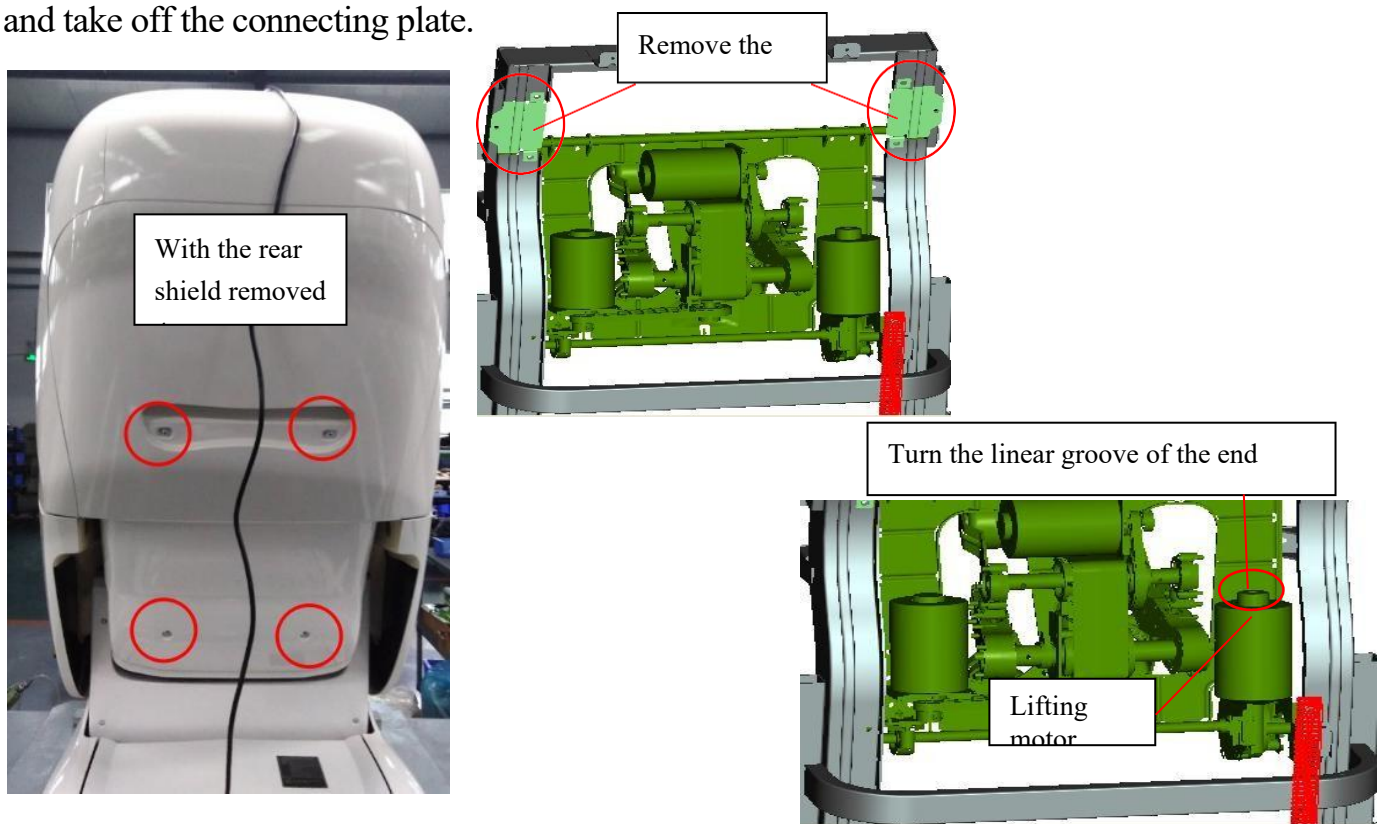

1. 3 Dismantling massage machine

1. 3. 1 If the lifting motor of the massage machine works normally, lift the massage machine to the top, turn the linear slot on the upper end of the lifting motor with a linear screwdriver to make the massage machine rise out of the rack; if the lifting motor of the massage machine does not work normally, directly

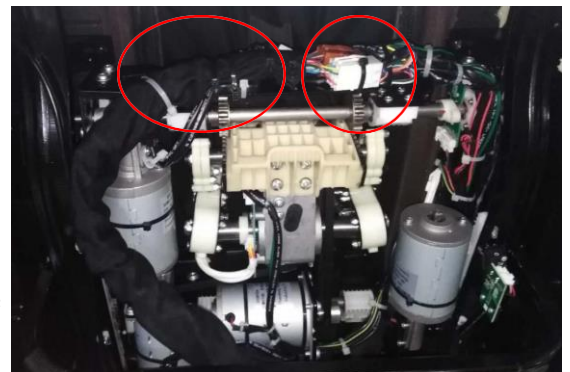



turn the linear slot of the lifting motor of the massage machine to make the massage machine out of the rack, and then take the massage machine down.

1. 3. 2 Remove the harness of the massage machine, cut off the cable tie, and unplug the harness connector of the massage machine. 1.3.3. Pay attention when removing the massage machine.

Be careful not to damage the limit switch on the right side of the backrest when removing the massage machine.

2. Replace solenoid valve assembly

2. 1 Open the front smock.

2. 1. 1 Unfasten the zipper connecting the back pad with the whole machine and take away the back pad.

2. 1. 2 Pull out the zipper of the front smock from the middle of the front end, pull it completely open, and fix the front smock to the upper end, so that the solenoid valve can be

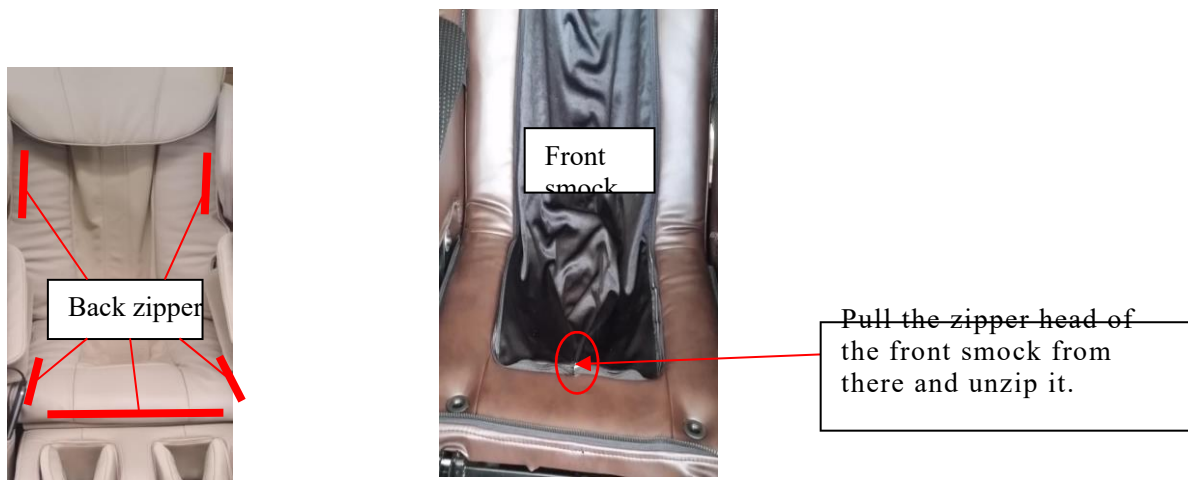

seen inward.

2. 2 Dismantle solenoid valve

2. 2. 1 Unplug the air pipe on the solenoid valve, and remove 2 screws on both sides of the solenoid valve with a Phillips screwdriver, so as to take down the solenoid valve.

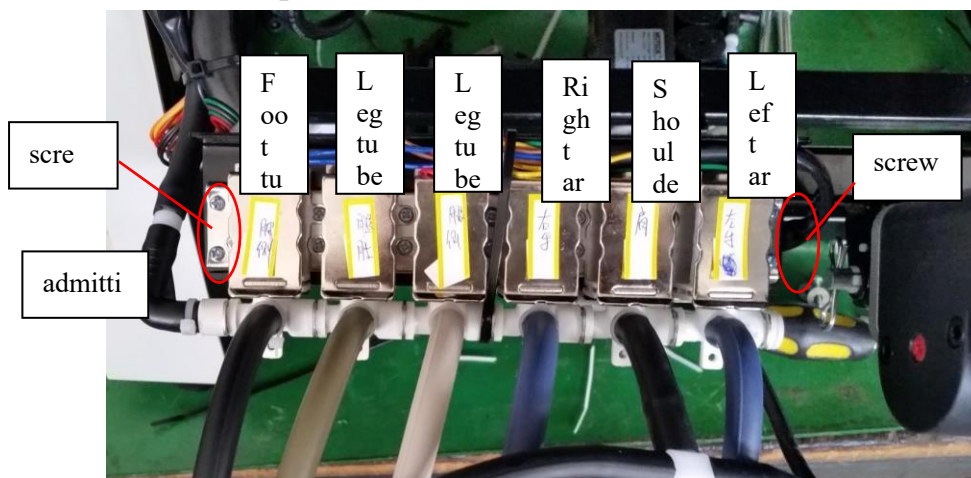

2. 2. 2 Remove the solenoid harness.

2. 3 Follow the reverse steps above to install the newly replaced solenoid valve assembly.

3. Replace the air pump.

3.1 Cut off the power and unplug the power cord.

3.2 Dismantle air pump

Remove the three screws of the power box cover with a Phillips screwdriver, and take off the power box cover; Find the air pump terminal along the air pump line, clamp the wire harness tie with pliers, and unplug the terminal; Then remove the four screws that fix the air pump with a Phillips screwdriver, and then pull out the air pipe inserted into the air pump, so that the air pump can be removed.

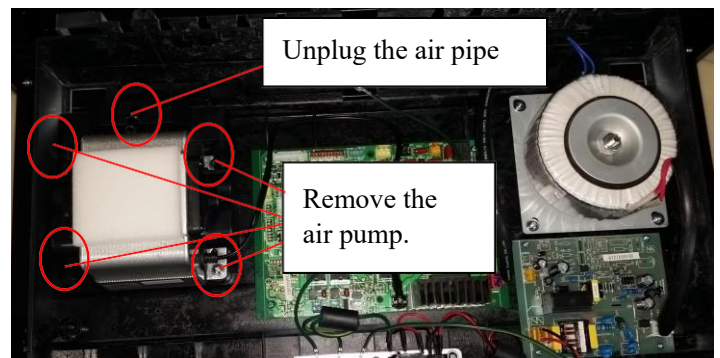
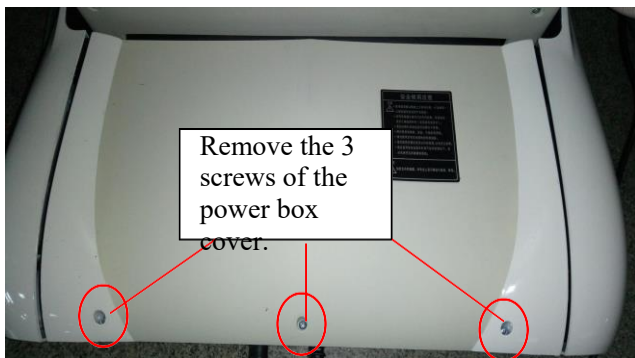

3.3 Install the new air pump according to the reverse steps above. Replace the electric strut for legs and feet.

4.1 Dismantle legs and feet

4.1.1 Uncover the snap fastener connecting the leg and cloth.

4.1.2 Remove the two screws that fix the leg and foot fixing plate with a cross screwdriver, lift up the leg and foot fixing plate, and take down the whole leg and foot

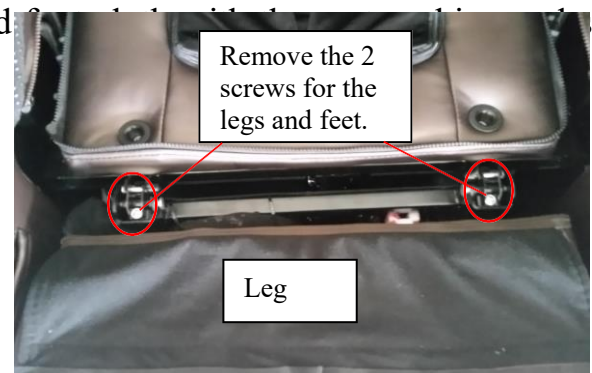



vertically upward;

4. 1. 3 Take down and put away the pin shaft, pine pin and plastic sleeve connecting the legs and feet with the whole machine.

4. 1. 4 Unplug the leg air pipe and connecting harness from the joint, and take the leg assembly away.

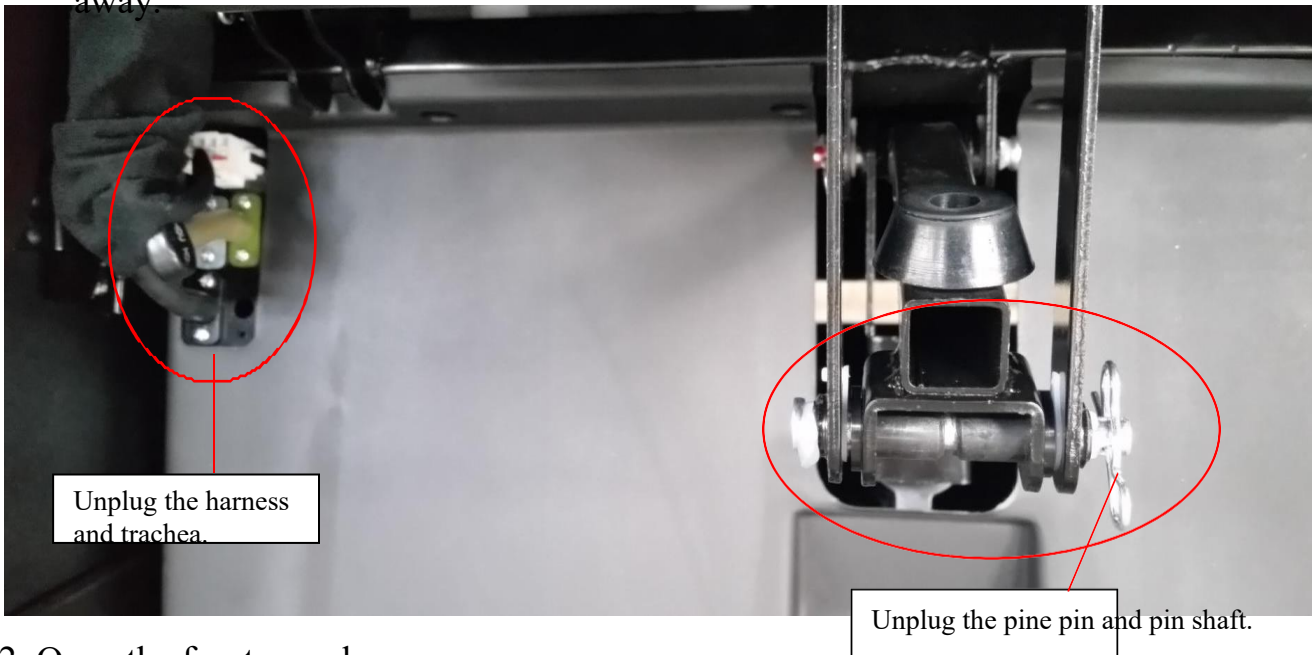

4.2 Open the front smock.

2.1. After unzipping the front smock, you can see the electric strut for legs and feet.

4.3 Remove the leg and foot electric strut harness.

4.4 Remove the leg and foot electric strut.

Pull out the pine pin and pin shaft at the front and rear ends of the electric leg brace respectively, and then take down the electric leg brace.

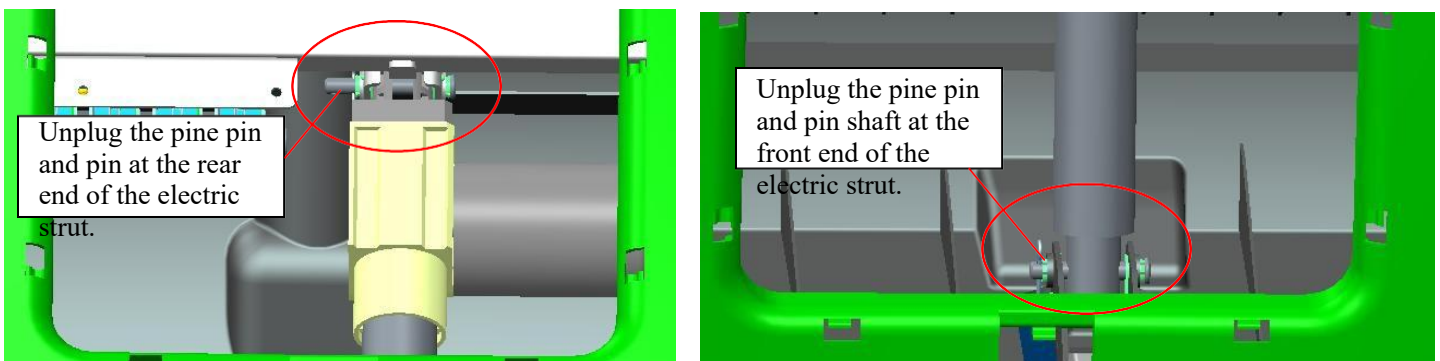

4.5 According to the reverse steps above, install the newly replaced electric strut for legs and feet. 5.

Replace the electric strut for backrest (2 people are required).

Note: In the process of disassembling the backrest electric strut, the backrest will fall



backwards, and someone needs to hold the backrest to avoid causing people.

And massage chairs.

5.1 Remove front baffle

Plug in the power plug and press the power switch, lift the legs and feet to the highest position with the hand controller, turn off the power switch and unplug the power plug,

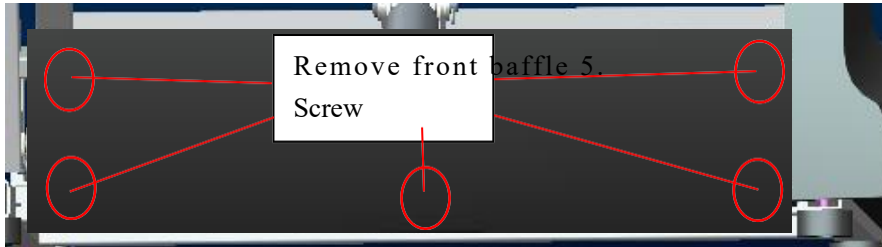

remove the five screws that fix the front bezel with a Phillips screwdriver, and take off the front bezel.

5.2 Remove the rear baffle

Remove the four screws of the tailgate with a Phillips screwdriver.

5.3 Remove the electric strut harness.

5.4 Remove the electric strut (two people are required)

One person holds the backrest forward, and the other person removes the electric strut of the backrest.



And then the pine pin and the pin shaft at the front end are unplugged, so that the electric strut can be taken down. When the first pin shaft is pulled

to facilitate the pin shaft to be

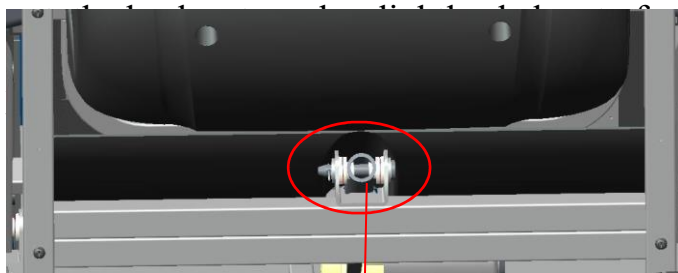

Unplug the pine pin and pin at the rear end of the electric strut.

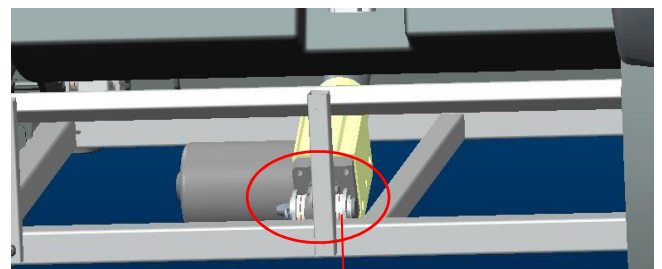

Unplug the pine pin and pin shaft at the front end of the electric strut.

5.5 Install the newly replaced electric strut



according to the reverse steps above. 6 Replace the foot massage roller.

6.1 Disassembly of legs and feet is the same as in 4.1.

6.2 Dismantle feet

6.2.1 Use a Phillips screwdriver to remove the screws that fix the shield, and take off the rear shield and bottom cover of the leg, as shown in the figure below.

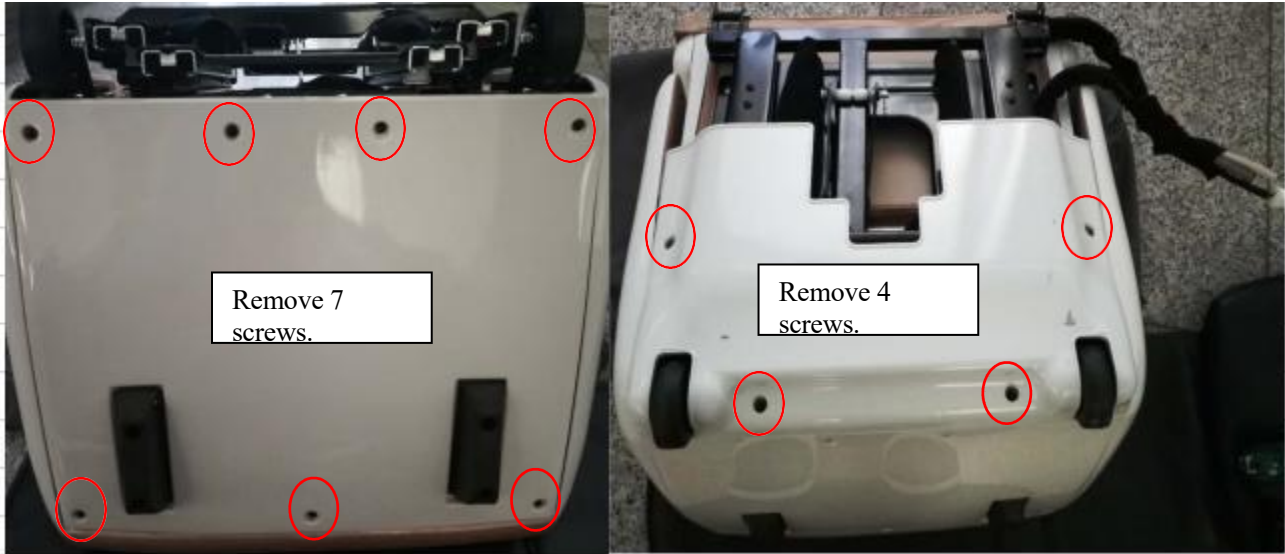

6.2.2 Remove the six screws that fix the feet with a cross screwdriver, and cut off the tie that binds the air pipe of the wire harness with oblique nose pliers to separate the air pipe of

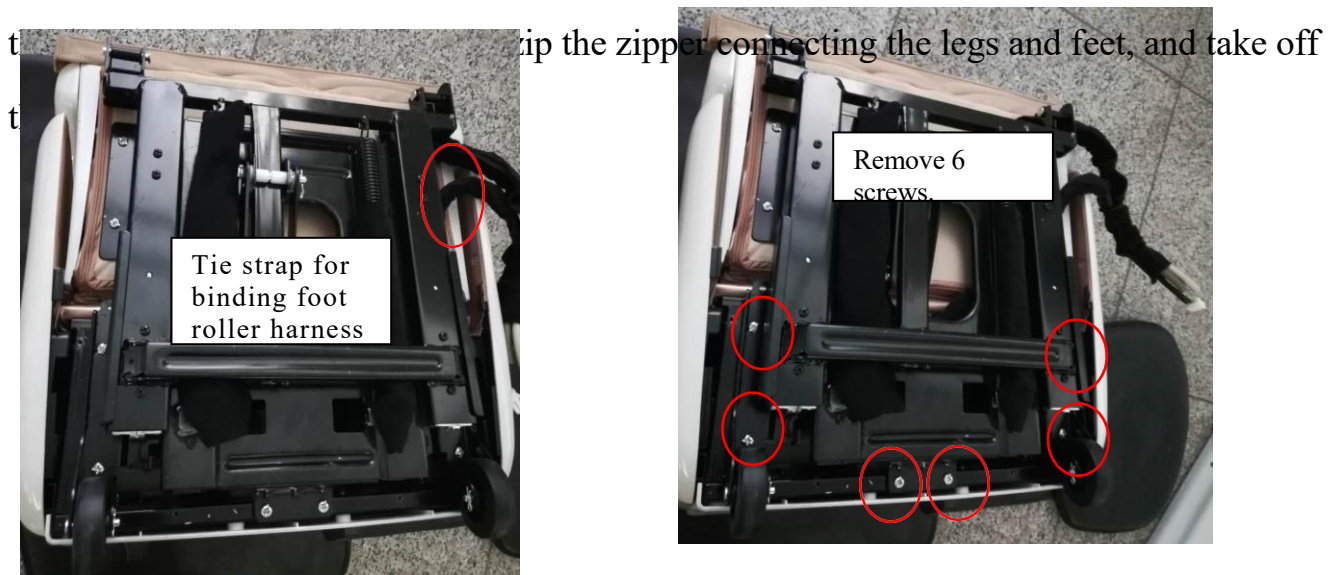

6.3 Disassemble the sole massage roller

6.3.1 Use a Phillips screwdriver to remove the four screws that fix the roller fixing plate.

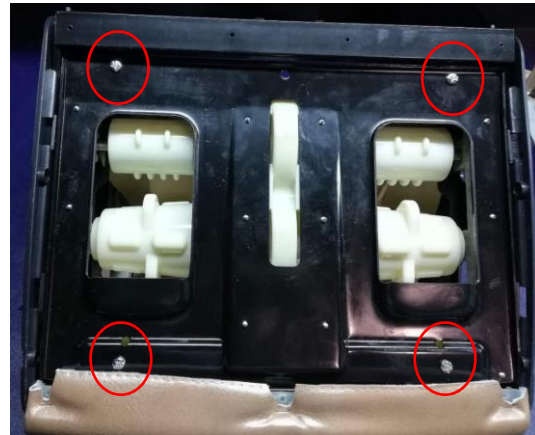

6.3.2 Remove the six screws that fix the sole roller with a cross screwdriver, cut off the tie of the bundle with an oblique nose pliers, and remove one screw that fixes the bundle of the

sole roller with a cross screwdriver to remove the sole roller.



6.4 Follow the reverse steps above to complete the installation of the foot massage roller. 7 Replace the armrest lamp panel.

7.1 The armrest lampshade is fixed by buckle, and forcibly break off the lampshade. Use a Phillips screwdriver to remove the four screws that fix the lamp plate and replace it.



8 Replace shoulder lamp belt.

8.1 1.1 Remove the rear shield.

8.2 Remove the outer shoulder

8.2.1 Remove the four screws that fix the outer shoulder with a cross screwdriver, cut off the tie that binds the wire harness with an oblique-nosed pliers, unplug the wire harness connector, and unzip the zipper of the shoulder airbag sewing product. Remove the eight

Lower

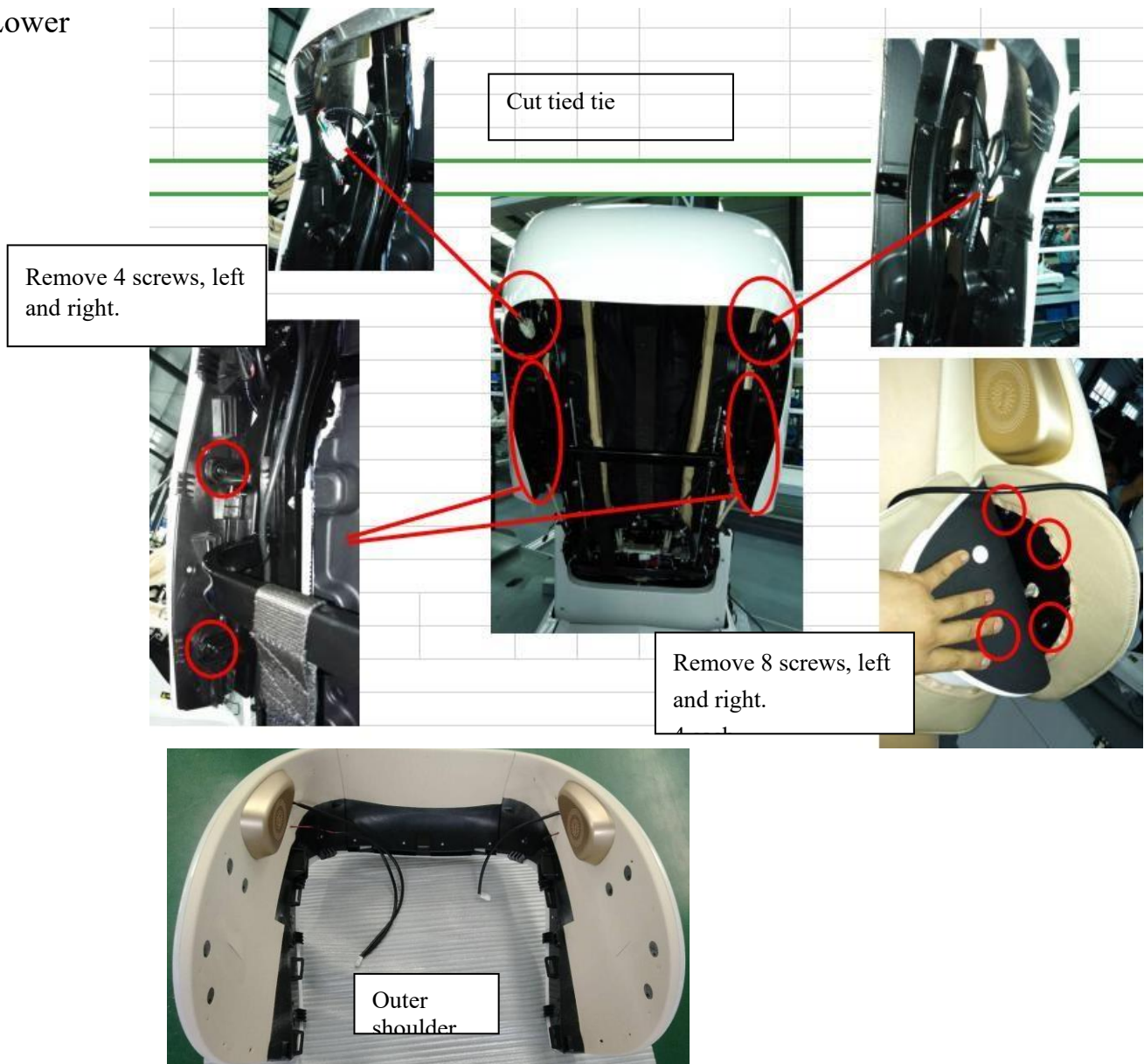

screws that fix the shoulder airbag and the outer shoulder with a cross screwdriver, pull the outer shoulder outward, and rotate backward. After the outer shoulder comes out of the



hook, lift it up to remove it.

8.3 Replace the lamp strip.

8.3.1 Disassembling the shoulder inner shell: remove the 7 screws fixing the middle inner shell of the shoulder with a cross screwdriver, then remove the 2 screws fixing the horn cover of the shoulder with a cross screwdriver, take off the horn cover, and remove the screws fixing the left/right inner shell of the shoulder with a cross screwdriver.

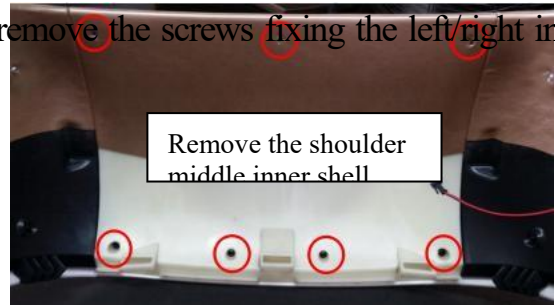
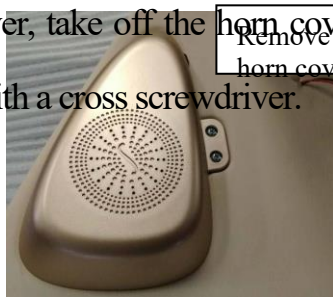

8.3.2 Replace the lamp belt: remove the six screws that fix the shoulder lamp belt with a cross screwdriver, and then replace the shoulder lamp belt.

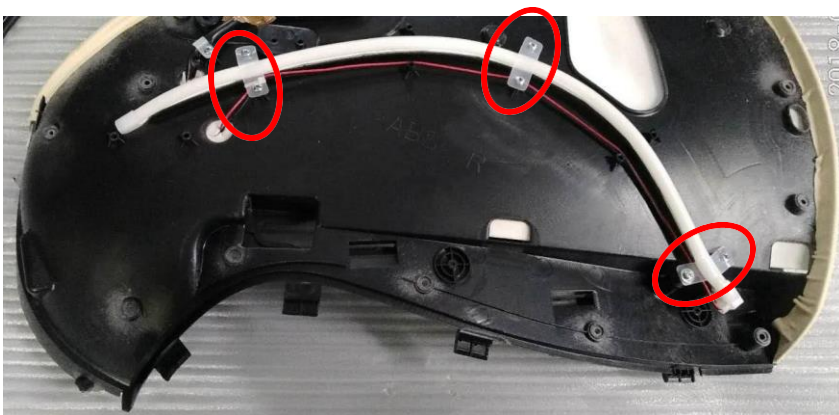

8.4 Follow the reverse steps above to complete the replacement of shoulder lamp belt.

IV. Wiring diagram of main circuit board port

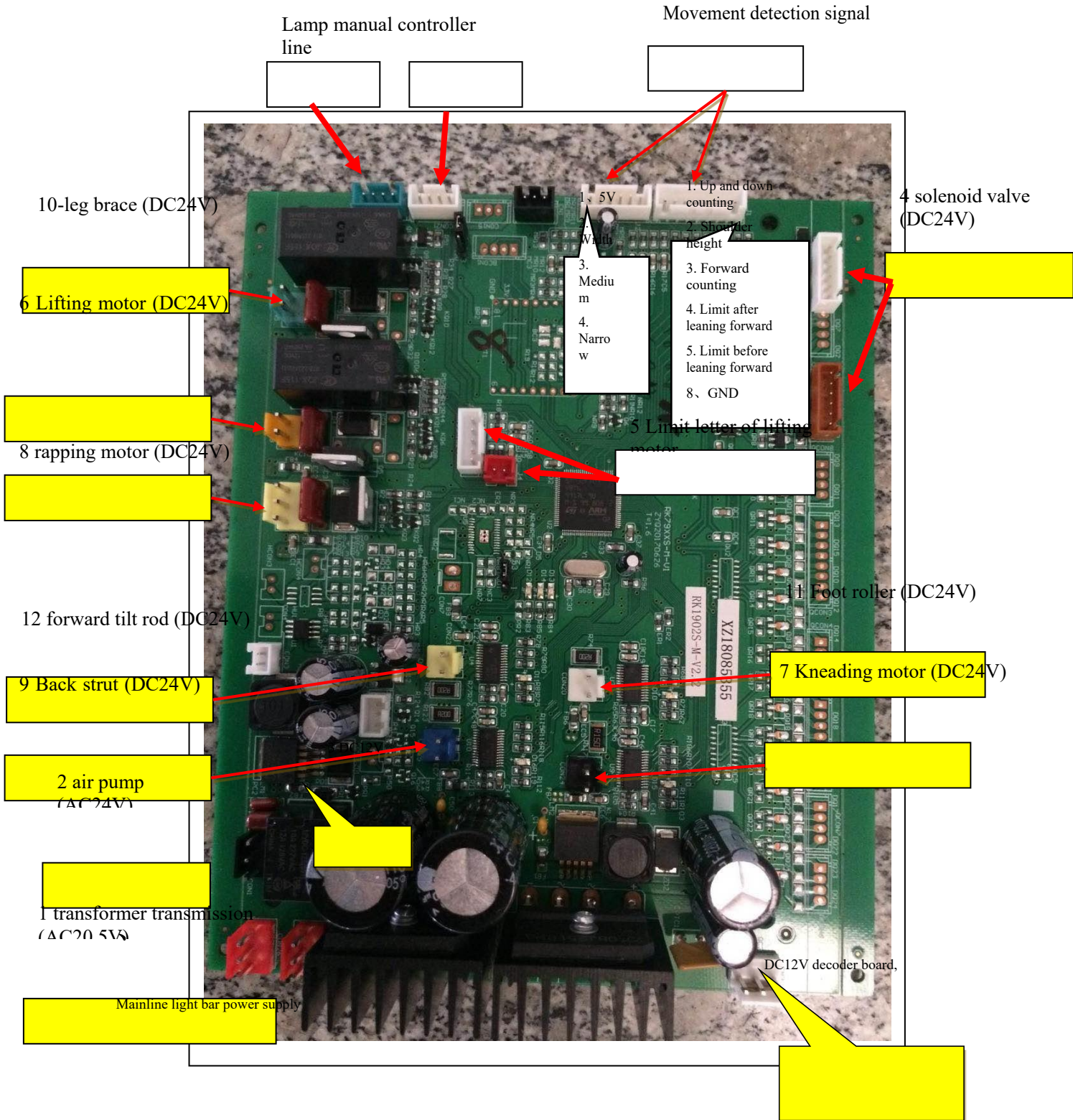

VI. System connection diagram

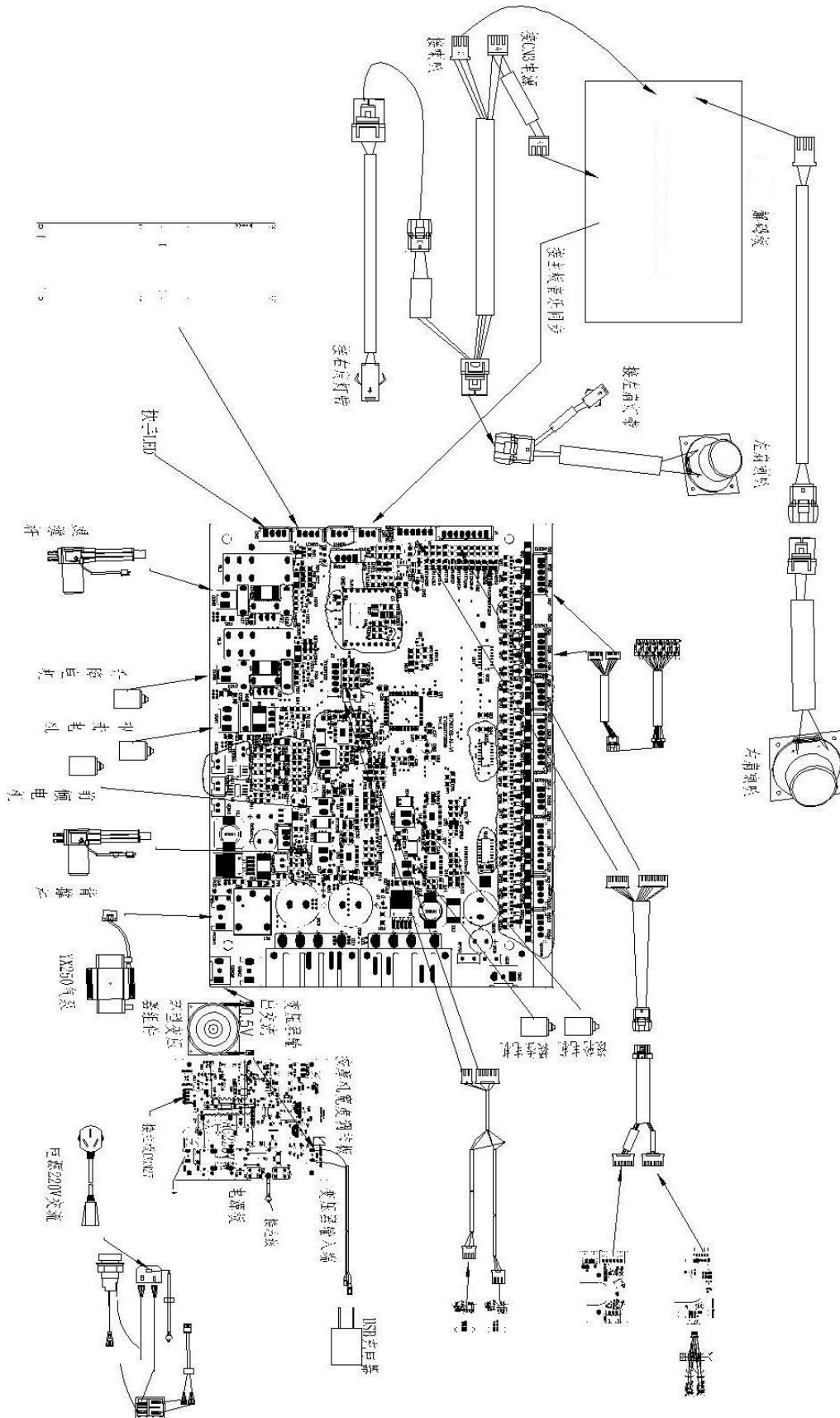

VII. Power-on timing and voltage distribution

1. Power-on timing diagram

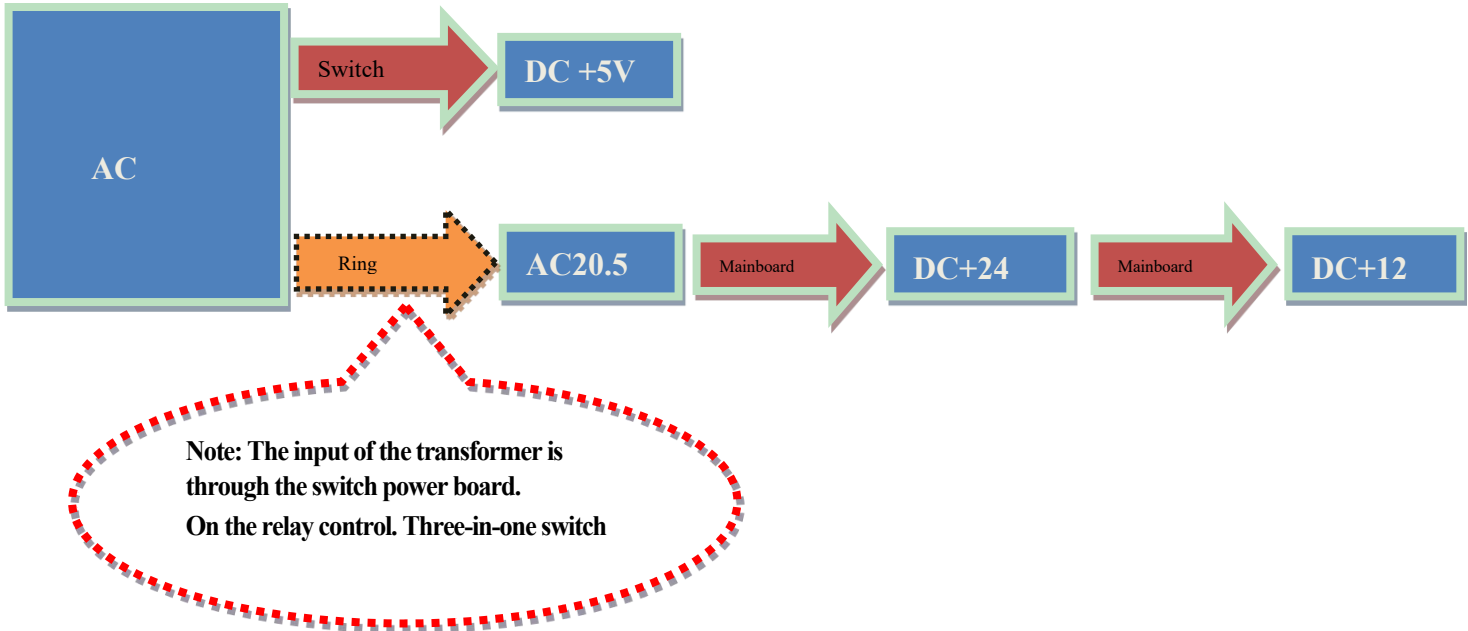

2. Voltage distribution diagram

