

Service Manual



Model:TP-3D Nexa

Service Dept

Content

- 1.Product parameters and function introduction
- 2.Structure of the massage chair
- 3.Disassembly diagram of the massage chair
- 4.Analysis and Repair of Massage Chair Faults
- 5.Tool list



1.Product parameters and function introduction

1.Product parameters

2.Product function

3.Remote control

4.Product size

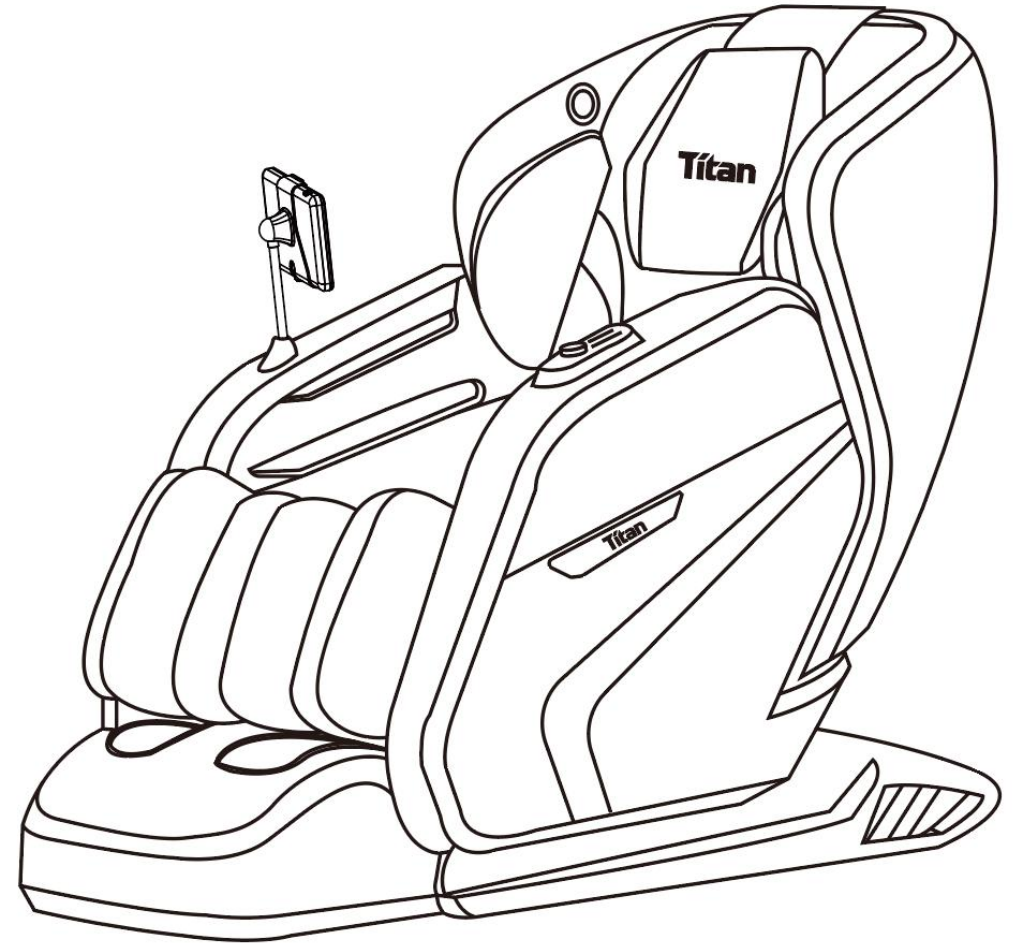

1.1.1·Product parameters

Product Specification	Product Description
Product name	Massage Chair
Model No.	Titan Pro 3D Nexa
Rated frequency	60HZ
Rated voltage	110V ~
Rated power	180w
Safety design	Class I
Net weight	209.4 lbs
Gross weight	249.1 lbs
Product size	60.2 * 28.1 * 44.9

1.2.1·Product function

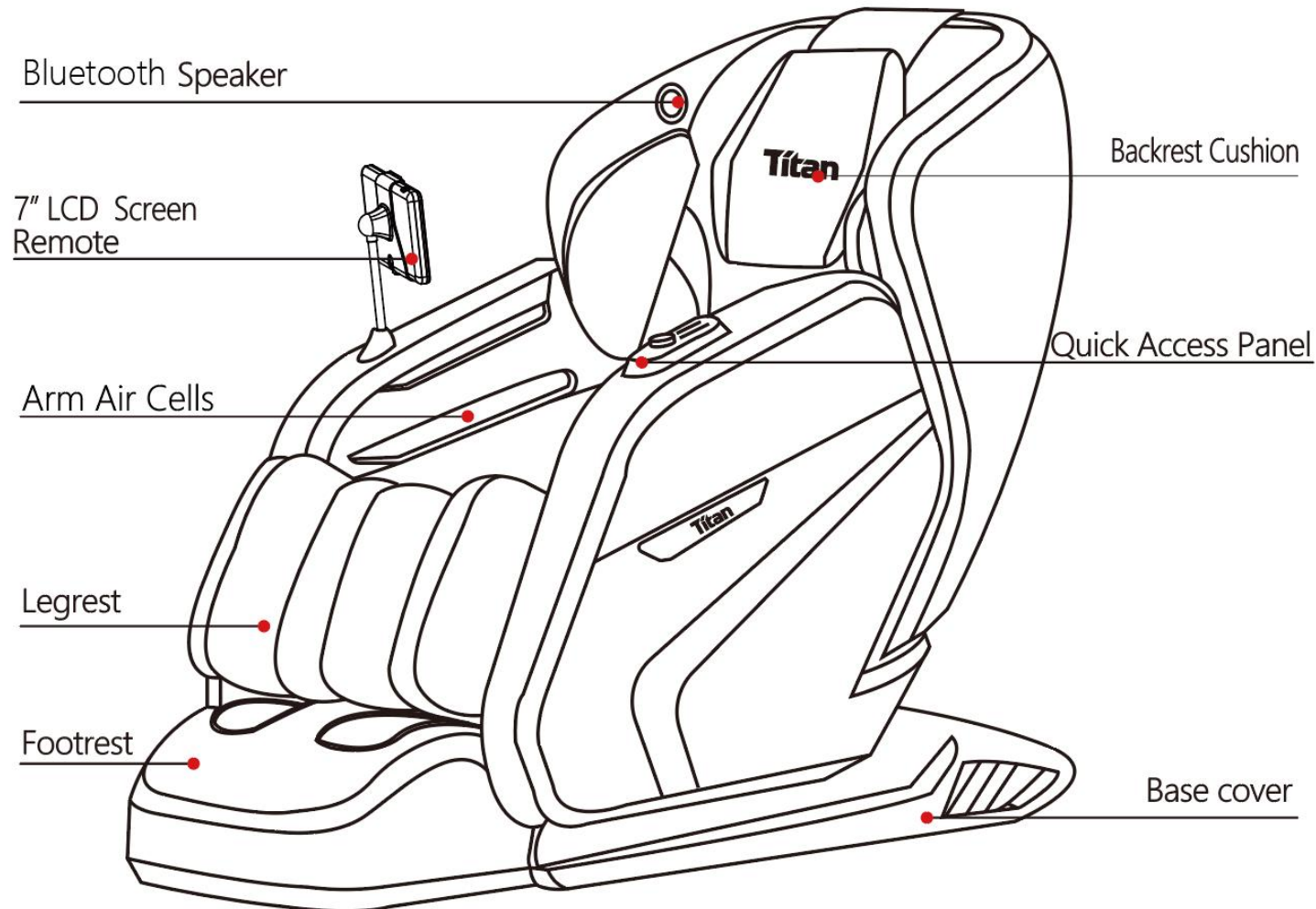

1.3.1 Remote control



1. Turn on LCD SCREEN to start massaging.



2. There are 6 options on the home page: "Auto", "Manual", "My Favorite", "Position Adjustment", "Dynamic Squeeze", and "Settings" .

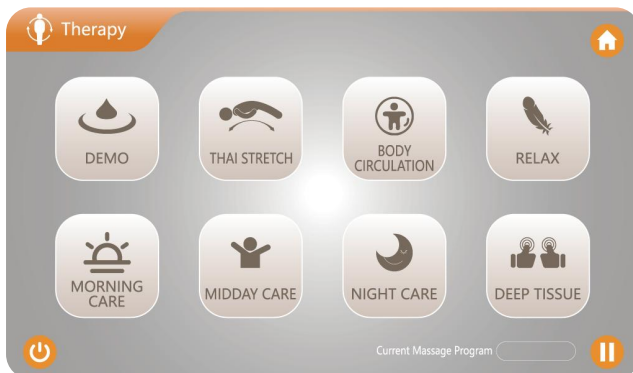

3. Click "Auto" and slide the interface left and right to enter Auto-Therapy. There are 8 automatic programs to choose from: "Demo", "THAI STRETCH", "BODY CIRCULATION", "RELAX", "MORNING CARE", "MIDDAY CARE", "NIGHT CARE", and "DEEP TISSUE".

1.3.1·Remote control

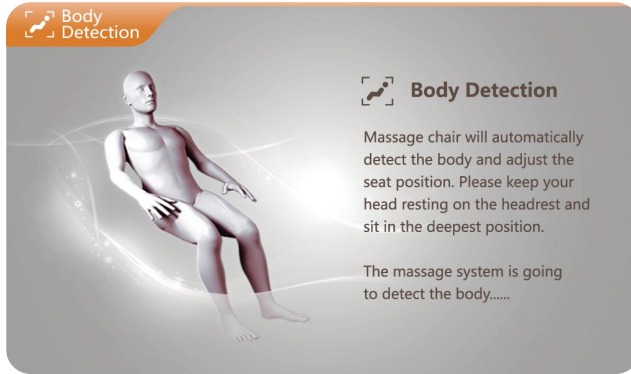

4. After selecting the automatic massage program, the body shape detection will be accurate. Please sit as far as possible to the deepest part of the seat back and rest your head on the pillow.



5. After the body detection is completed, the shoulder position can be adjusted manually. Press the "up/down" button to adjust, and press the "OK" key to confirm.



6. Click "Target" and slide the interface left and right to enter Classic-Target. There are 8 automatic programs to choose from: "EXTENSION", "WOMEN'S HEALTH", "SHIATSU", "MEN'S HEALTH", "OFFICE RELIEF", "SPORTS RECOVERY", "FOOT CARE", and "REJUVENATE".

1.3.1·Remote control



7. Click "Focus" and slide the interface left and right to enter Classic-Focus. There are 8 automatic programs to choose from: "NECK MASSAGE", "NECK AND SHOULDER MASSAGE", "BACK MASSAGE", "LUMBAR MASSAGE", "WAIST HIP MASSAGE", "LEGS MASSAGE", "UPPER BODY", and "LOWER BODY".



8. Enter the custom massage interface. You can choose "Area Selection", "Roller Width" or "Massage Technique" to begin a custom massage.

1.3.1·Remote control



1. Massage technique

"Kneading", "Kneading & Tapping", "Knock", "Tapping", "Shiatsu", and "Combination", 6 massage methods can be selected. Click the corresponding icon to turn it on or off.



2. Area selection

After the massage method is selected, you can select three massage areas of "Full range/interval/fixed point" according to your personal preference, and press the "up/down" arrow to adjust the movement position.



3. Roller width

Select "Wide", "Narrow" or "Medium" to control the width of the movement massage.
(It is effective when non-manipulation is turned on.)

1.3.1·Remote control

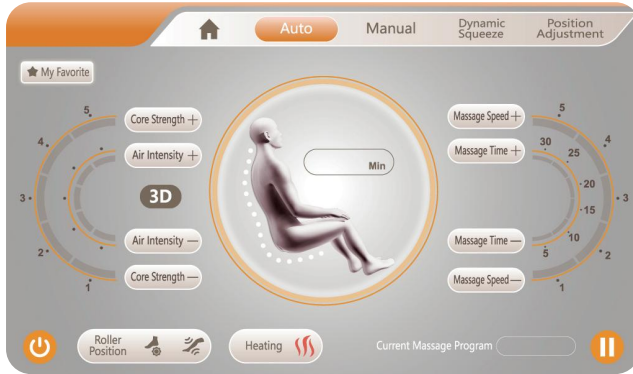

9. "After entering the force adjustment interface, you can adjust "3D", "Core Strength", "Air Intensity", "Massage Speed," and "Massage Time".



10. Enter the "Dynamic Squeeze" menu to turn the airbag massage on/off for "Full Body", "Shoulder", "Arm", and "Leg & Feet".



11. After entering the position adjustment interface, you can press and hold "Backrest Down", "Backrest Up", "Footrest Down", "Footrest Up", "Foot Shrink", "Foot Extend", Button for manual adjustment of sitting posture. You can also select three preset sitting positions: "zero gravity", "watching Tv", and "reading".

1.3.1·Remote control



12. After entering the function setting interface, you can adjust "Foot roller", "Leg Kneading", "Heating" Can be turned on/off "Voice Control", "Bluetooth", "Key Tone" After entering the system Settings page, you can select "Language" to choose the language.

Select "Sleep Timer" to adjust the time to sleep,

Select "Backlight" to adjust the brightness of screen

Select "Voice Control", "Key Tone", "Bluetooth".

1.3.1·Remote control

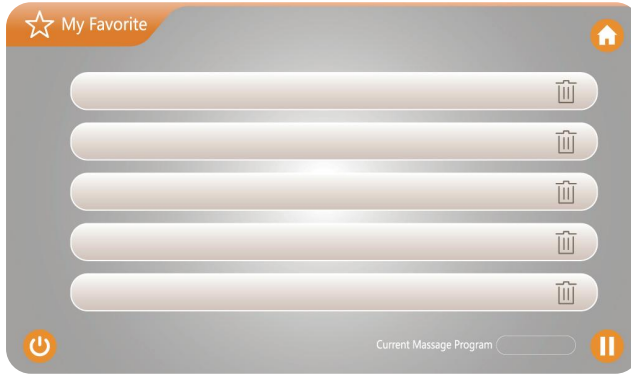

13. FAVORITES page: You can add the programs you like into it and when you feel uncomfortable you can delete it by.

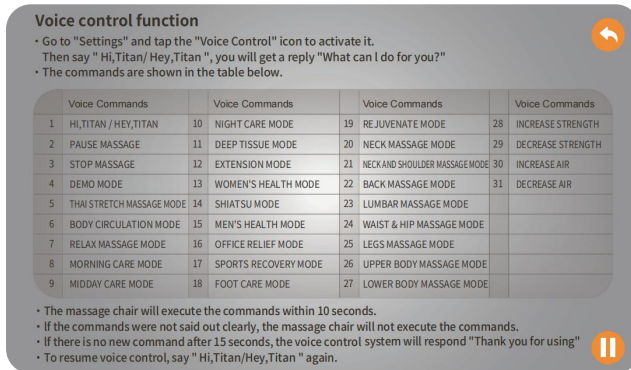

14. Go to "Setting" and tap the "Voice Control" icon to activate it. Then say "Hi, Titan/Hey, Titan", you will get a reply "What can I do for you?"

1.3.2·Shortcut buttons

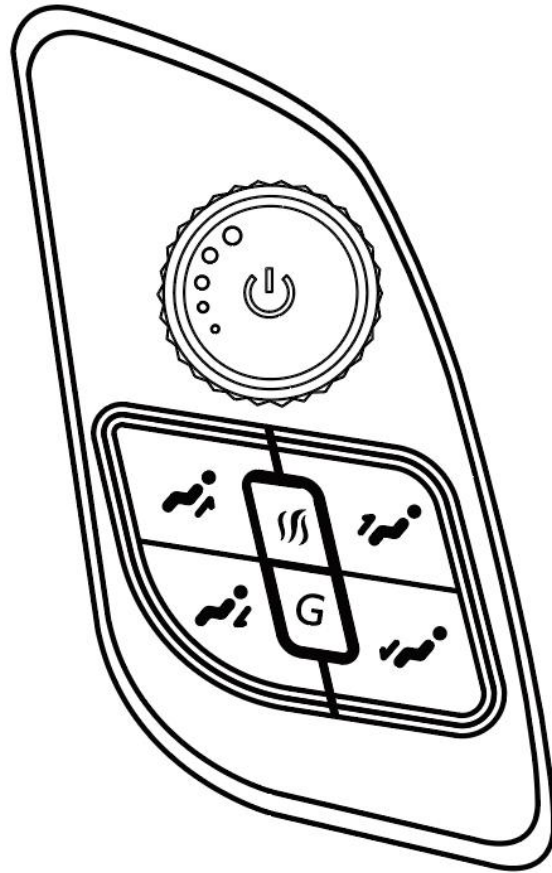

Rotate to adjust back roller force



Click to turn on/off chair



Press and hold to raise backrest



Press and hold to recline backrest



Press and hold to raise calfrest



Press and hold to lower calfrest



Turn on/off heating



Turn on/off zero gravity

1.4.1·Product size

Carton size



2. Structure of the massage chair

1. Component name

2. Internal part drawing

3. Internal wiring diagram of the power box

2.1.1·Component name

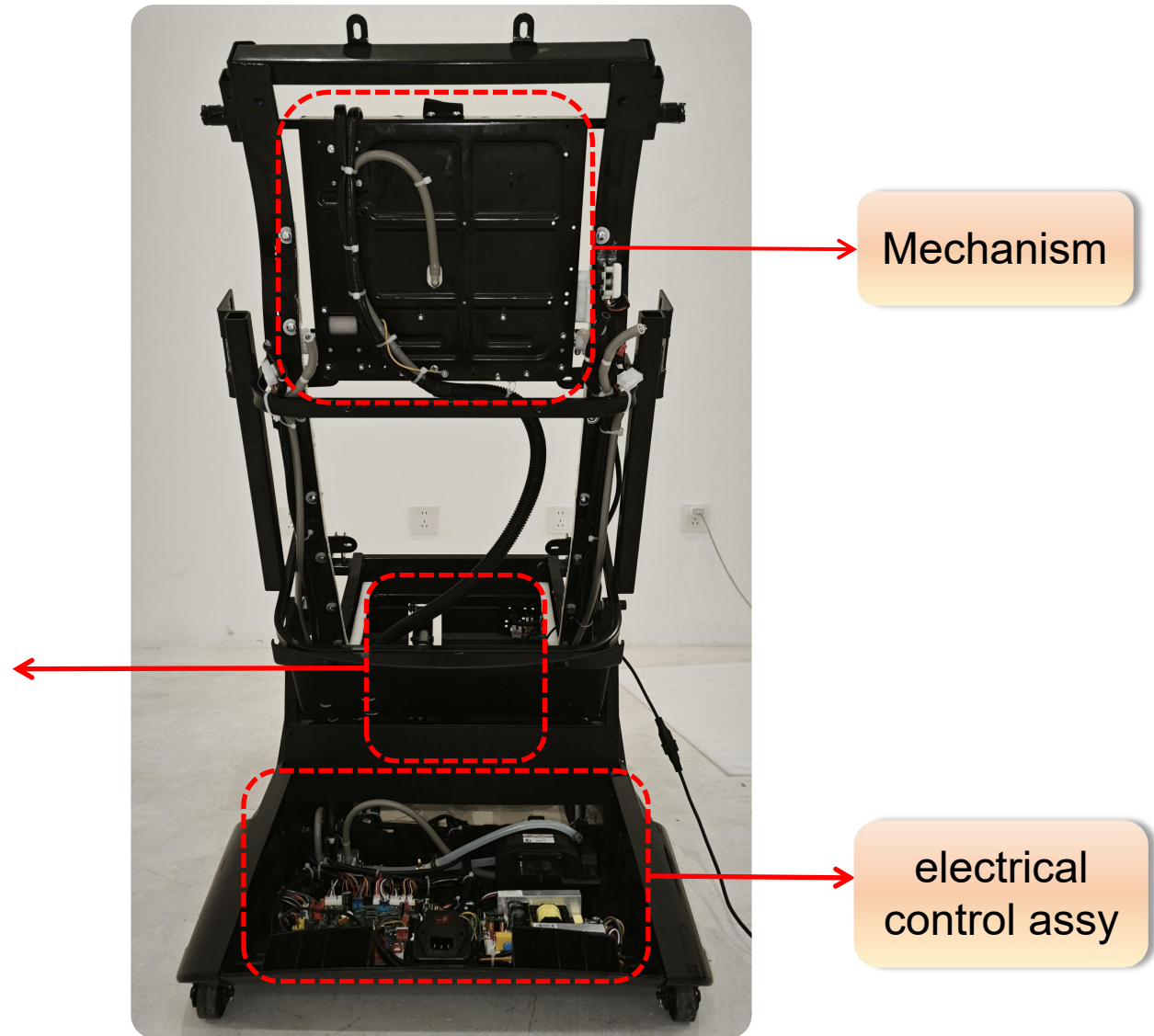
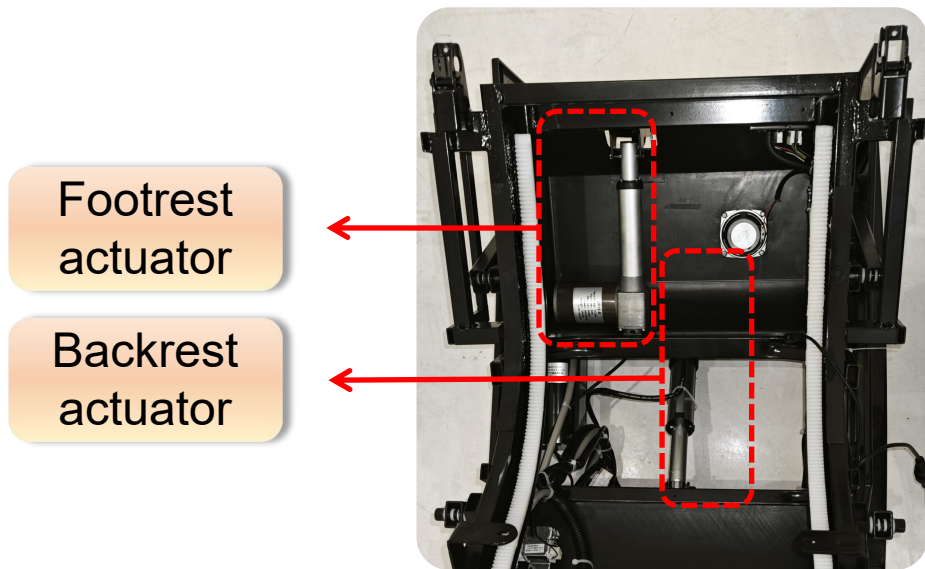

2.2.1·Internal component diagram

Main PCB

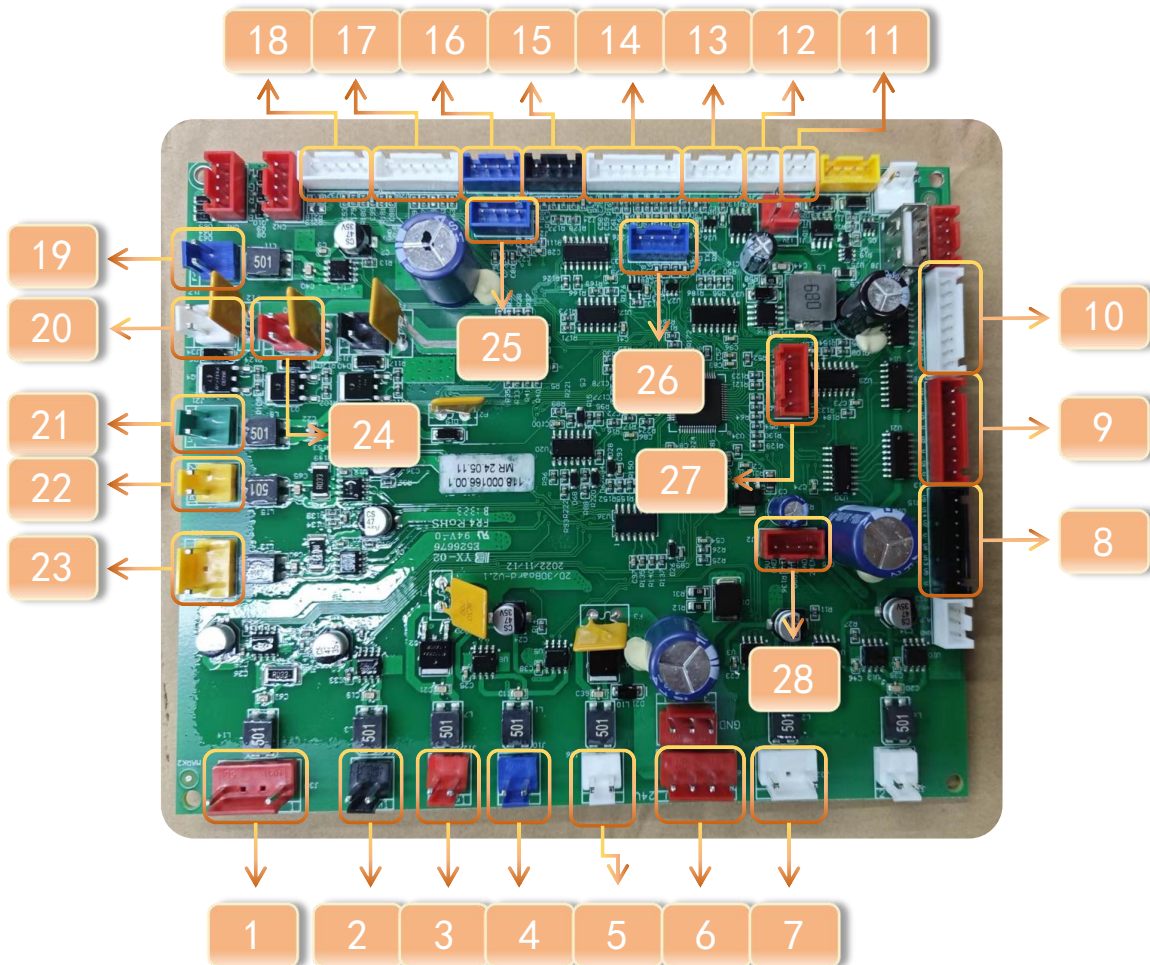

No.	Port function	No.	Port function	No.	Port function
1	footrest actuator	13	remote control tablet	25	Voice control
2	mech walking motor	14	WMN shoulder signals of the mech,kneading, walking count,foot signals	26	Bluetooth
3	mech knocking motor	15	upper and lower limit signals of the mech	27	program download port
4	mech kneading motor	16	shortcut key	28	DC 5V input
5	Reserve	17	Arcade button signal under the feet		
6	24V DC input	18	Anti-pinch signal		
7	24V air pump	19	foot roller		
8	Leg air valve	20	Foot heating		
9	air valve on left & right armrest	21	Leg motor		
10	air valve on mech airbag	22	foot lift motor		
11	Light on armrest	23	backrest actuator		
12	Light on armrest	24	Waist heating		

2.2.2·Internal component diagram

Power supply Bluetooth PCB

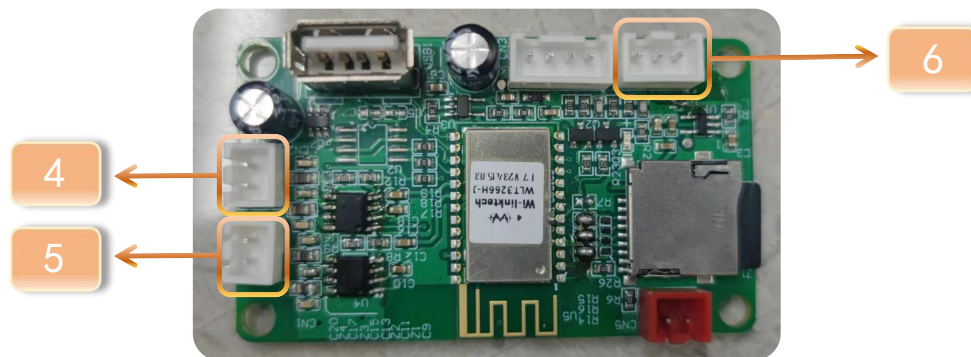

No.	Port function
1	AC220V input
2	DC5V output
3	DC24V output
4	Right audio signal output
5	Left audio signal output
6	Power amplifier board control line

2.3.1 · Internal wiring diagram of the power box

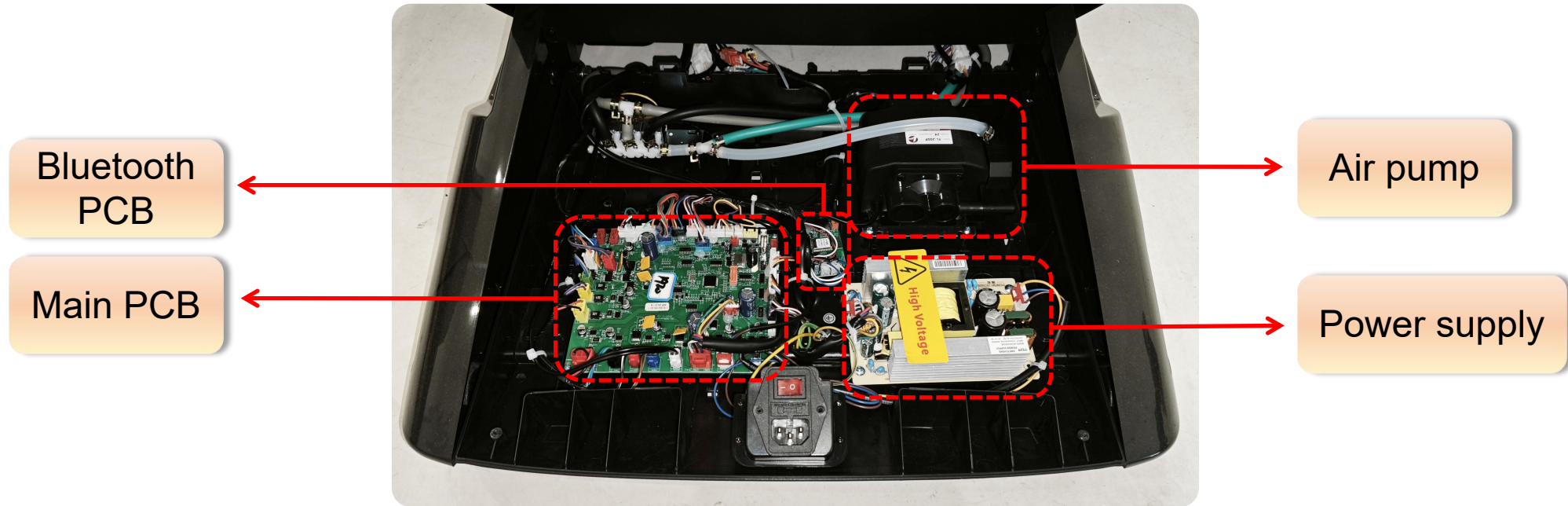

3. Disassembly diagram of the massage chair

1. Remove the cushion

2. Remove the footrest

3. Remove the back cover

4. Remove the backrest

5. Remove the armrest

6. Remove the mechanism

7. Remove the power box

8. Remove the side panel

9. Remove the actuator

3.1.1·Remove the cushion

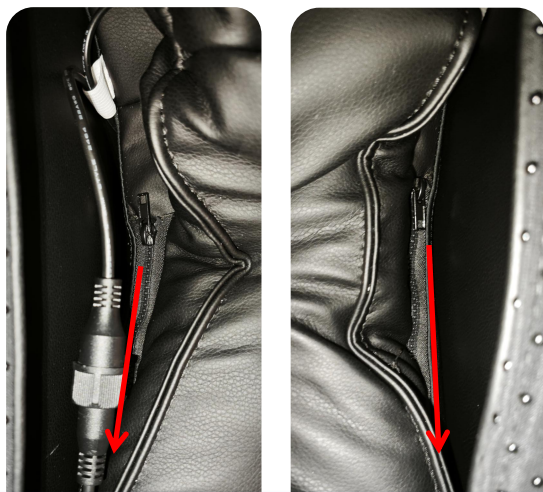

① Pull the zipper at the position shown in the picture

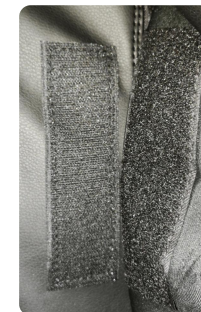
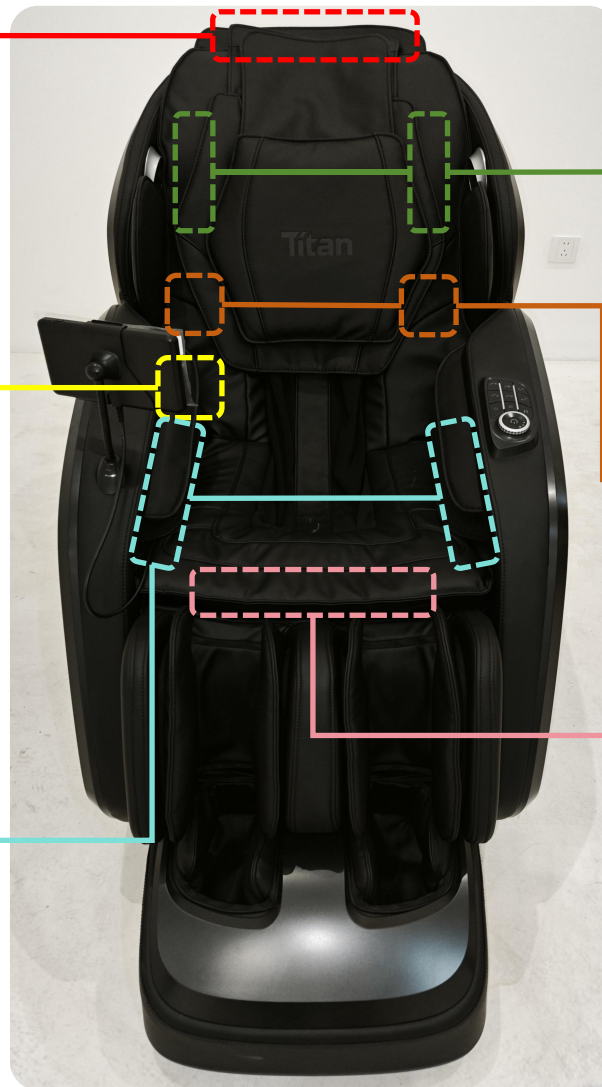

② Remove the heating connection terminal

3.1.1·Remove the cushion



Cushion assy

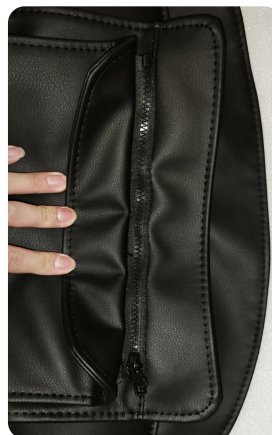

Unzip the zip



Small
Pillow



Big
Pillow



Cushion

3.2.1·Remove the footrest

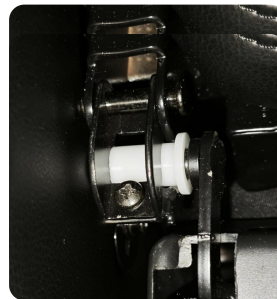

① Remove 2 pcs
fixing screws



② Remove the air pipe
and the connection
terminal



Footrest assy

3.2.2·Remove the footrest



Remove the
footrest assy



① Remove 7pcs screws &
cut off the cable tie



Back cover
of the foot

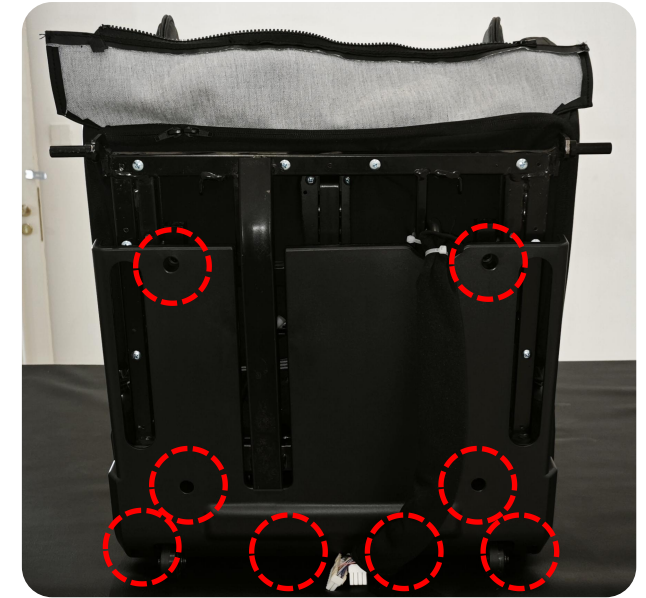

② Remove 8pcs
screws

3.2.2·Remove the footrest



Back cover
of the foot

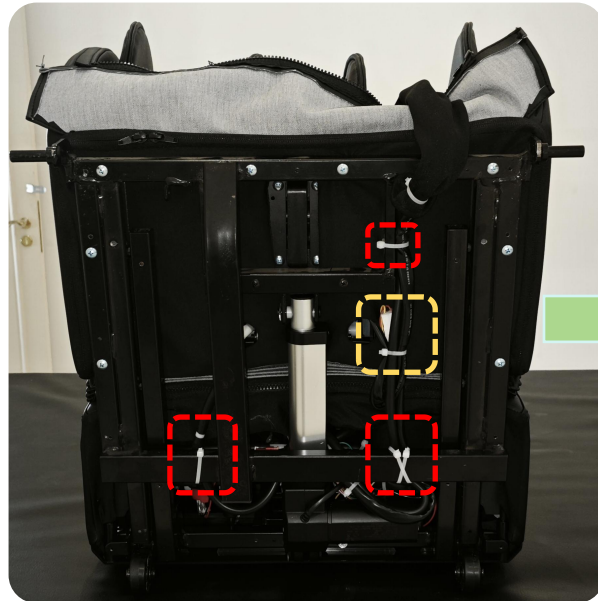

③ Cut off the cable ties
& remove the
connection terminals
and the air pipe

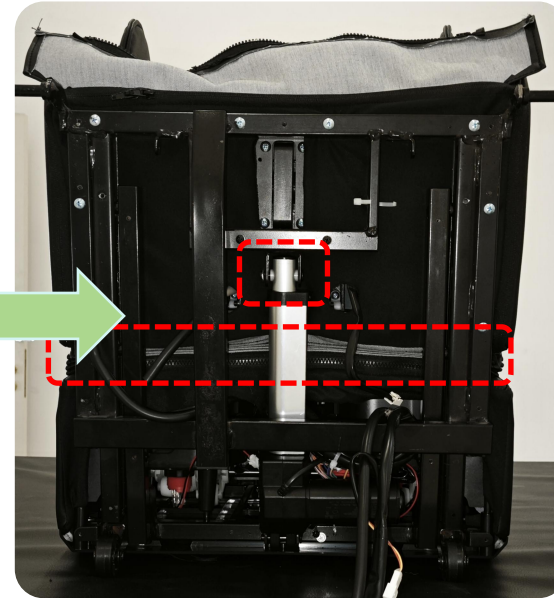

④ Remove the
pin of the footrest
actuator

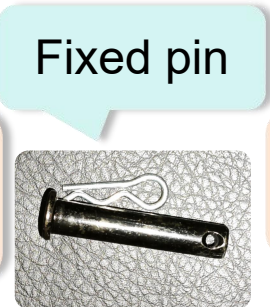

⑤ Unzip
the zipper

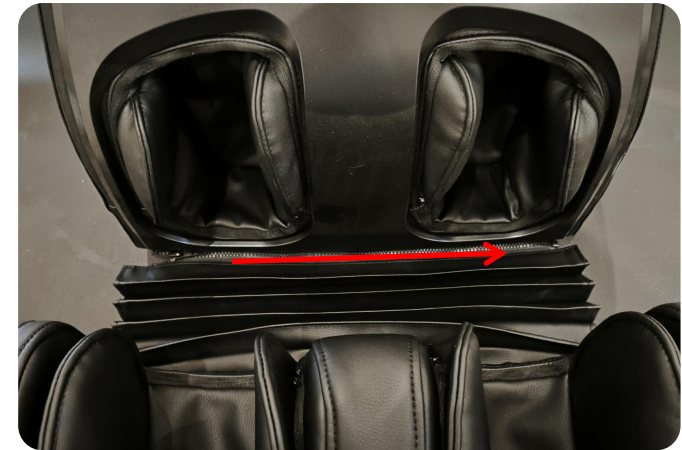

3.2.2·Remove the footrest



Foot assy

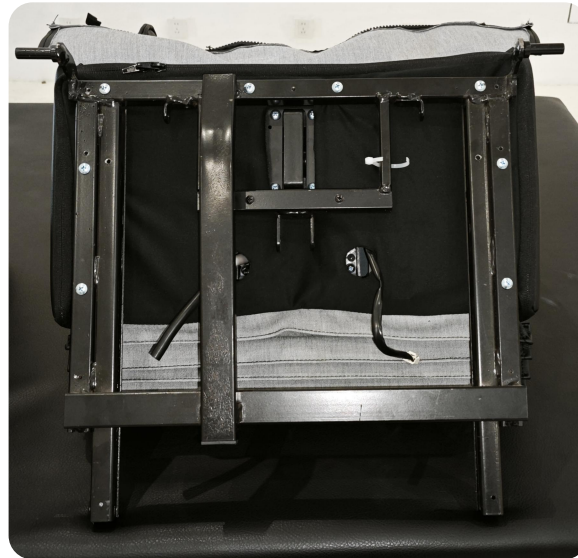

Leg assy

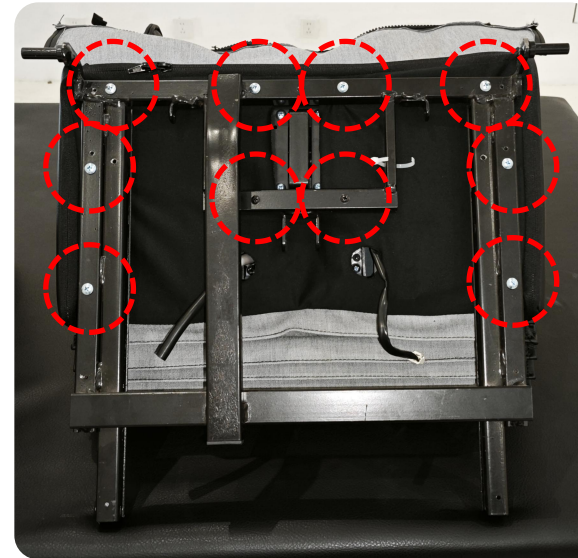

⑥ Remove
10pcs screws

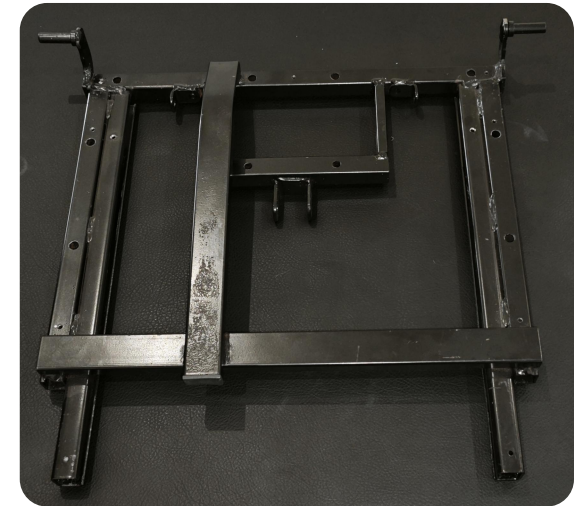

Leg welding
part

3.2.2·Remove the footrest



⑦ Zip the zipper



Leg kneading
assy

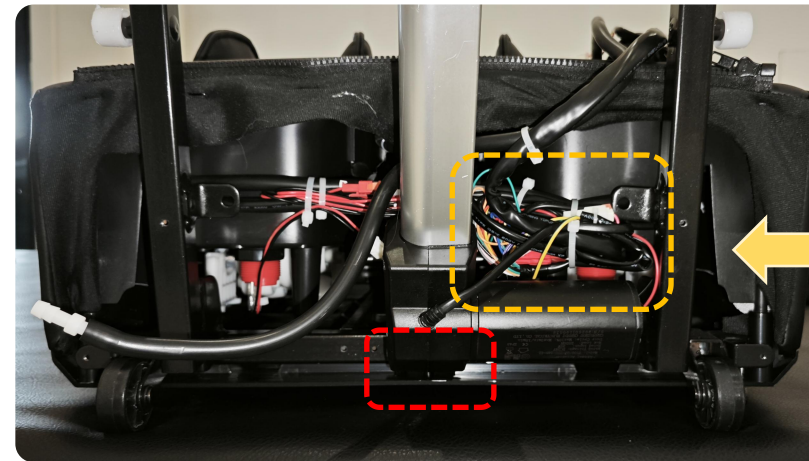

⑧ Cut off the cable ties & remove
the pin of the footrest actuator

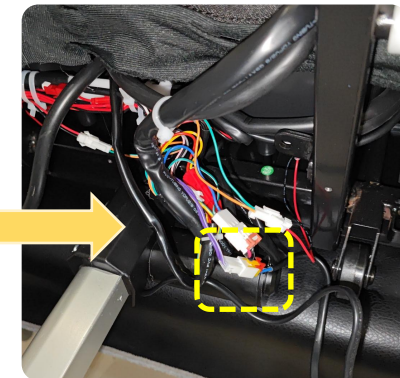

3.2.2·Remove the footrest



Foot extension
actuator

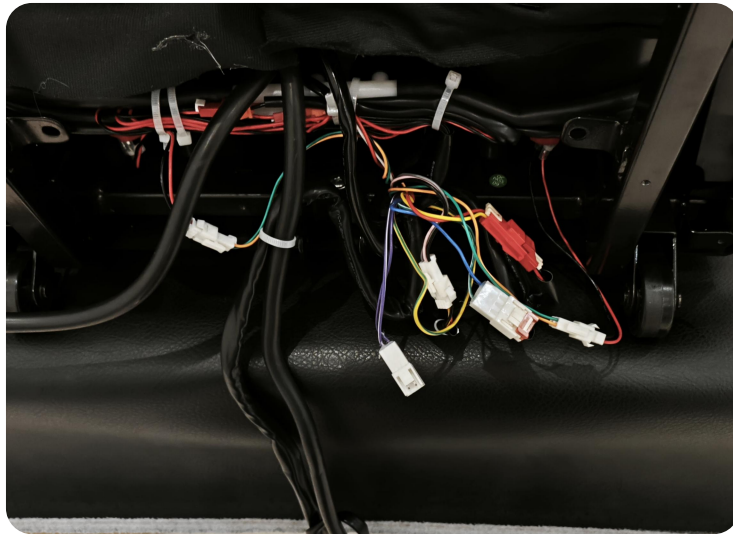

⑨ Unplug the
connection
terminals

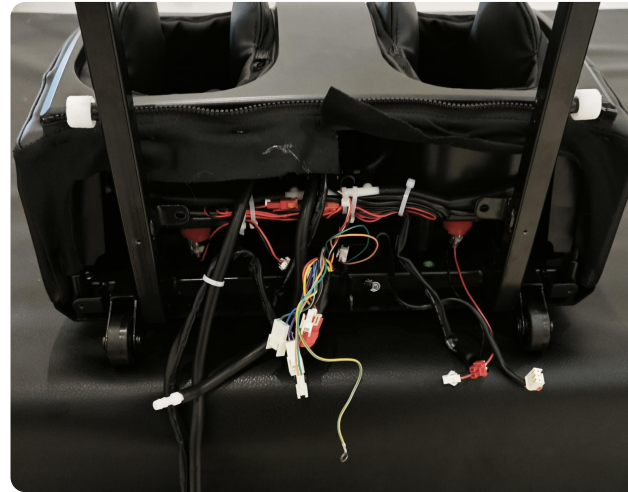

⑩ Remove the
screws that fix
the ground wire



⑪ Unzip the zipper
& remove the fixing
screws

3.2.2·Remove the footrest

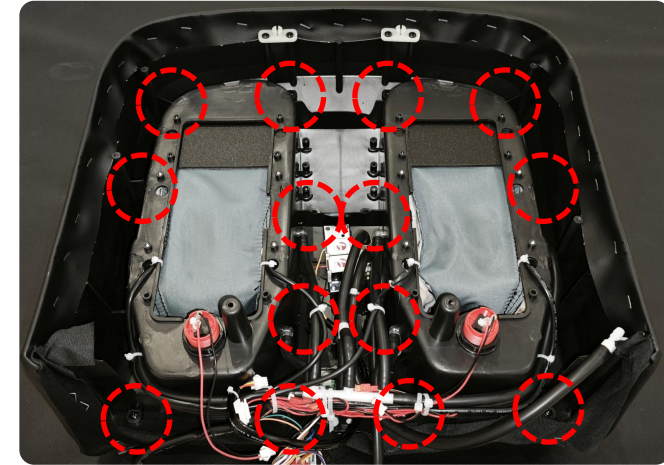
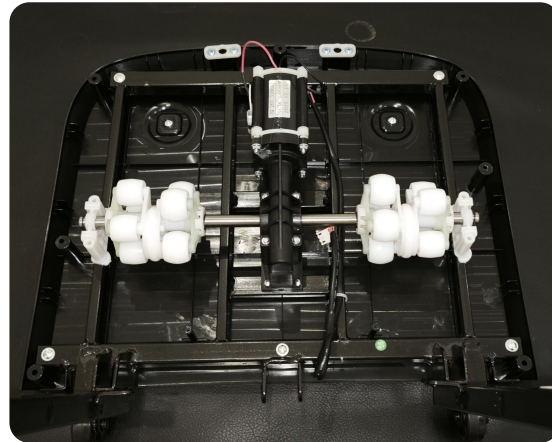

⑫ Remove 7pcs screws

Screw type



Foot bottom cover assy

Foot upper cover assy

⑬ Remove 14pcs screws

Screw type



3.2.2·Remove the footrest

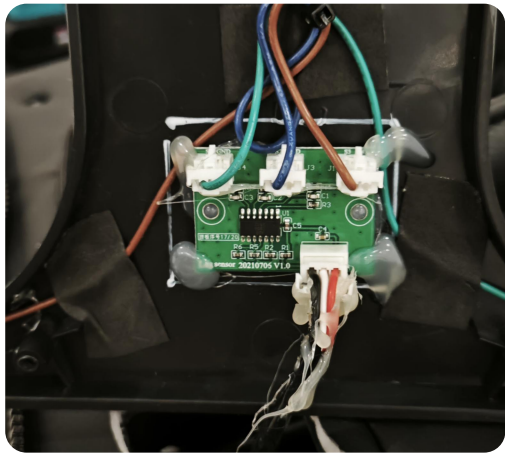

⑭ Unplug the connection terminals



Outer foot cover

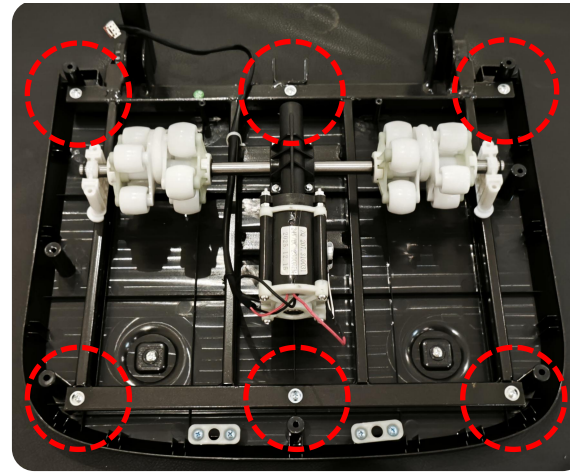

⑮ Remove 6pcs screws

Screws type

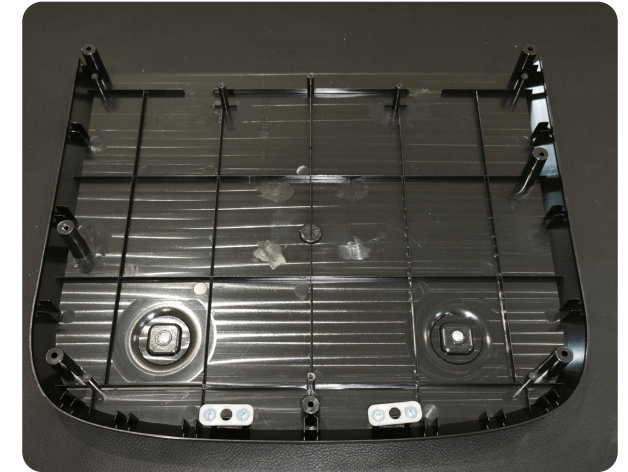

Foot bottom cover

3.2.2·Remove the footrest

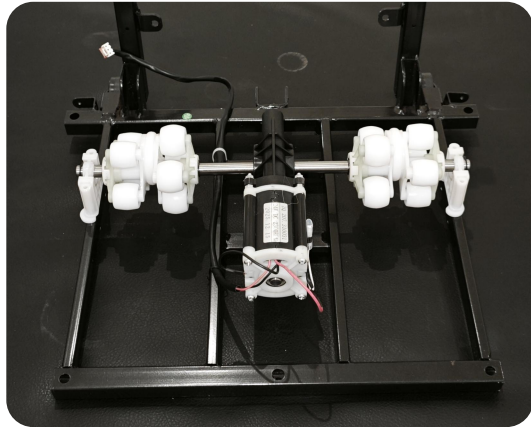

Foot roller
assy

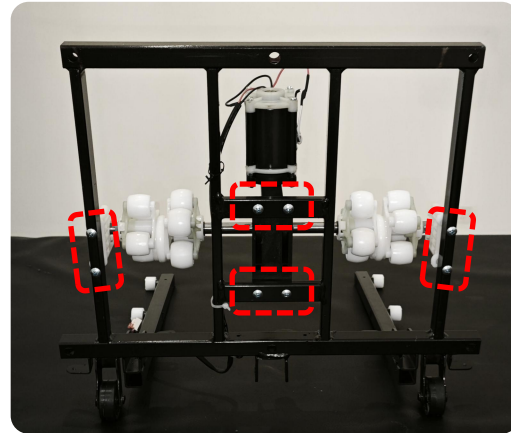

⑩ Remove the
fixing screws



Foot welding
part

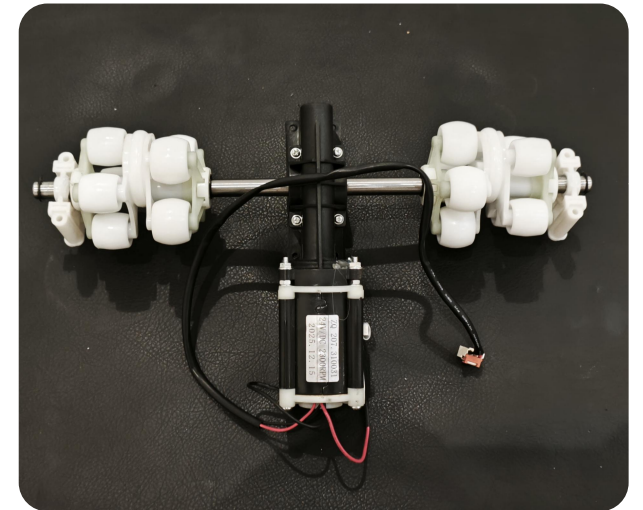

Foot roller

3.3.1·Remove the back cover



① Remove the
fixing screws



Back cover

3.4.1·Remove the backrest



Remove the
backrest assy



① Remove 6pcs
fixing screws

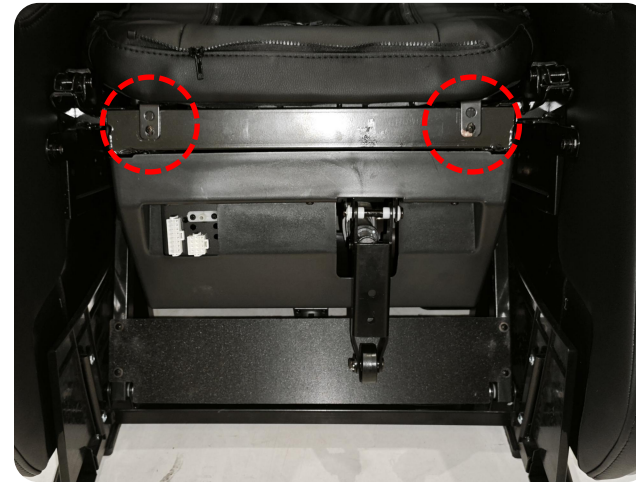

② Remove 2pcs
fixing screws



Backrest
assy

3.5.1·Remove the armrest

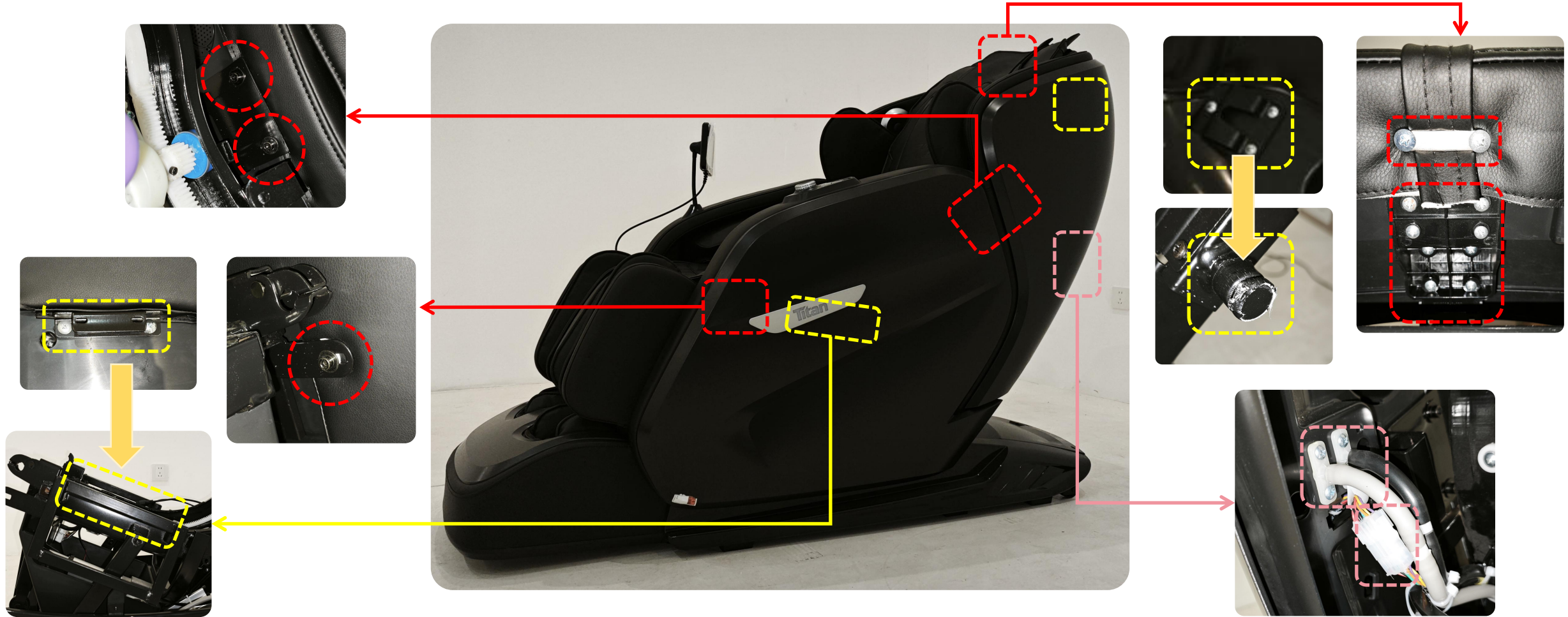

① Remove 3pcs fixing screws

② Remove the air pipe & the connection terminal

Note:same remove way of left & right armrest

3.5.1·Remove the armrest



Left armrest
assy

3.5.1·Remove the armrest

Remove the trim
on the left armrest

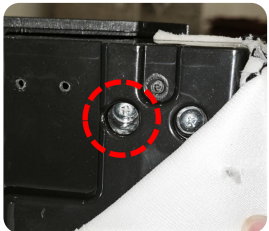
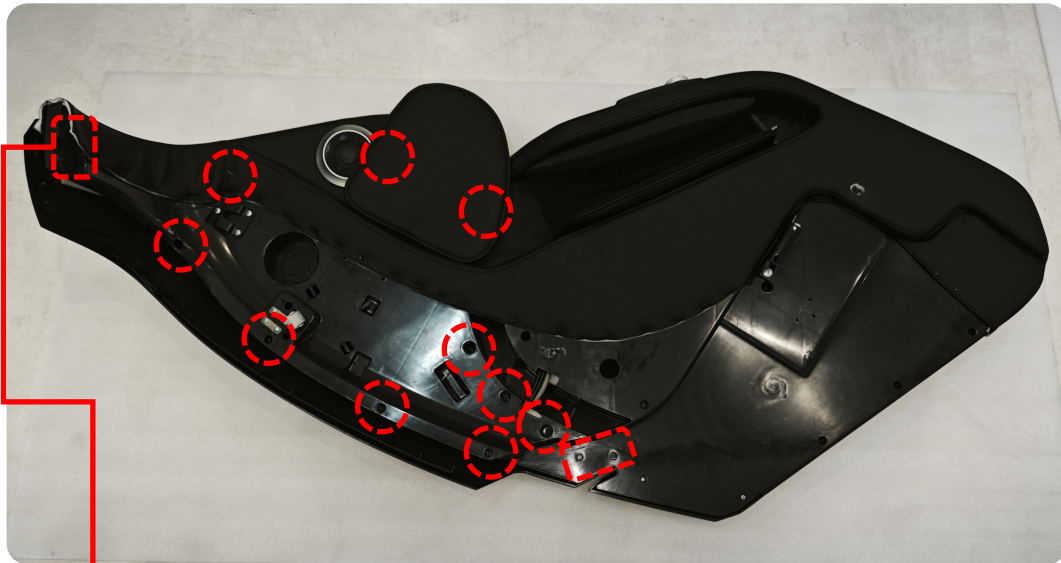

① Unzip and remove
the fixing screws

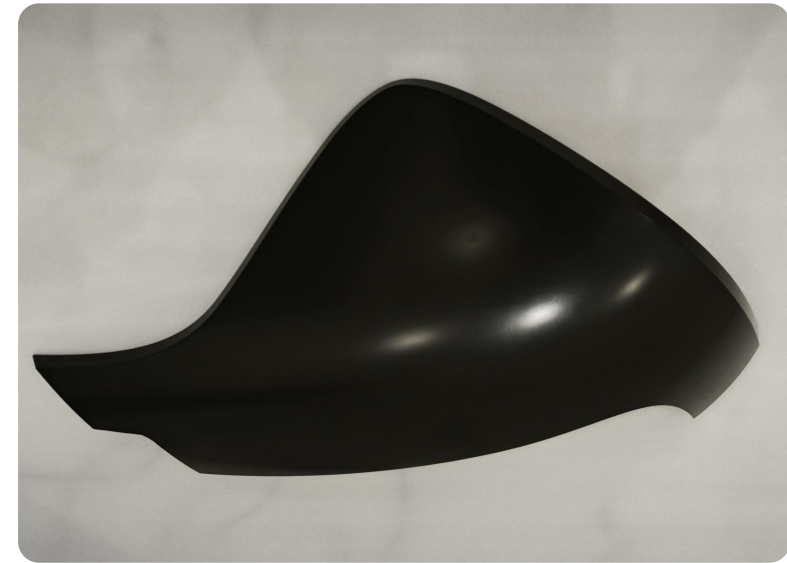

Left shoulder
cover

3.5.1·Remove the armrest

Remove the trim
on the left armrest

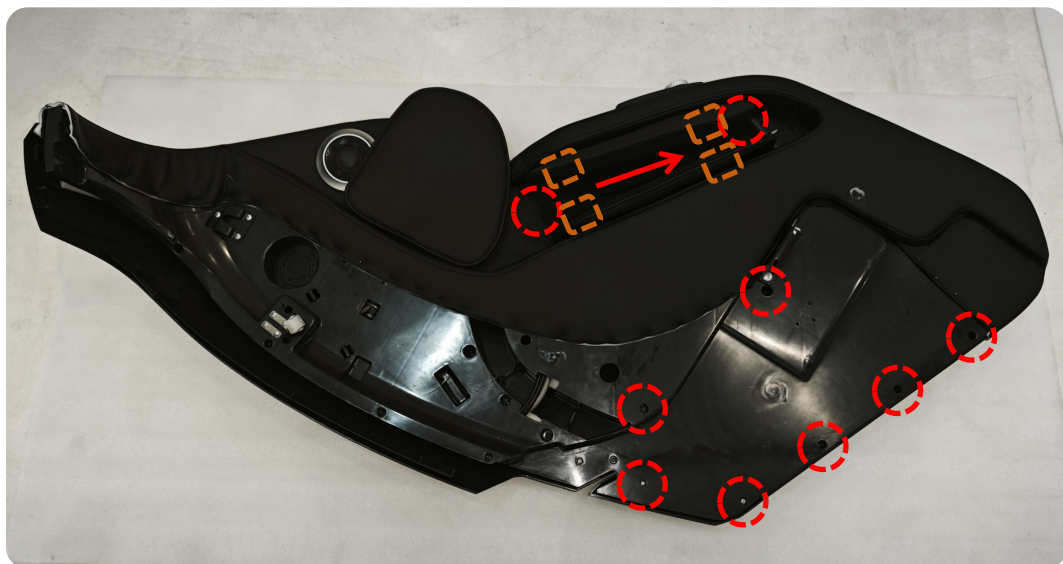

② Unzip the the
zipper of airbag &
remove the fixing
screws

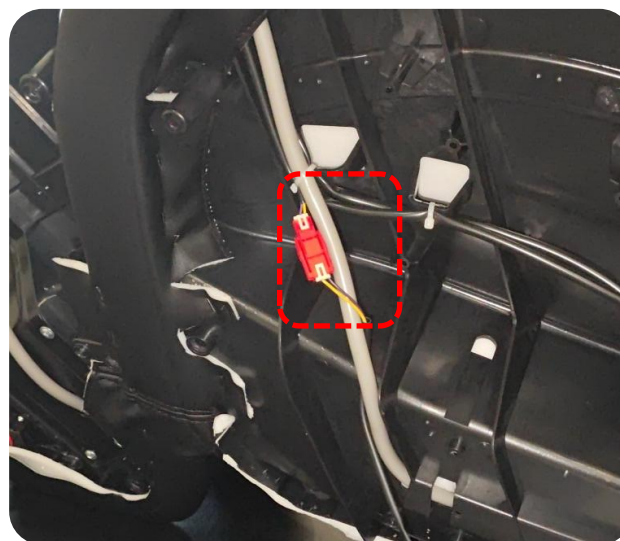

③ Unplug the
connection
terminals



Left side panel
outer cover assy

3.5.1·Remove the armrest

Remove the trim
on the left armrest

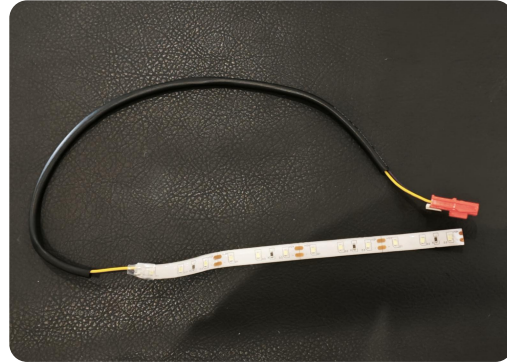
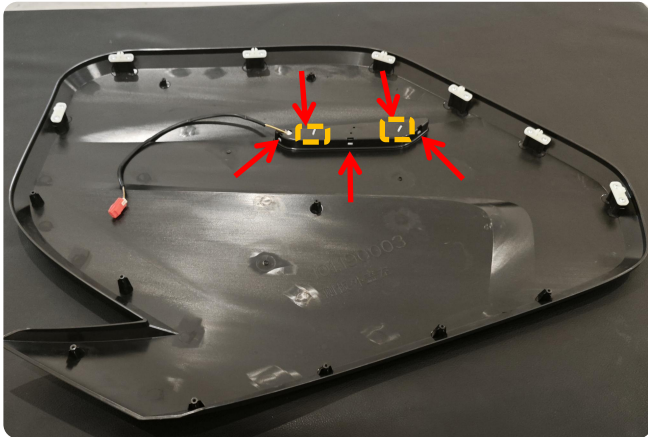

④ Remove the left
lampshade with a tool.
Cut off the fixed cable
ties & remove the
lamp strip

White lamp
strip

Left
lampshade

Left outer cover
of side panel

3.6.1·Remove the mech

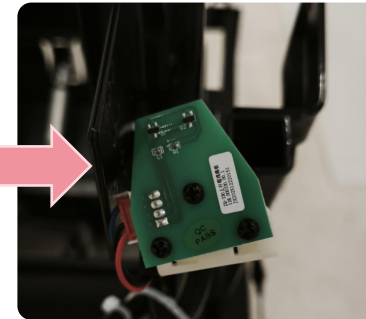
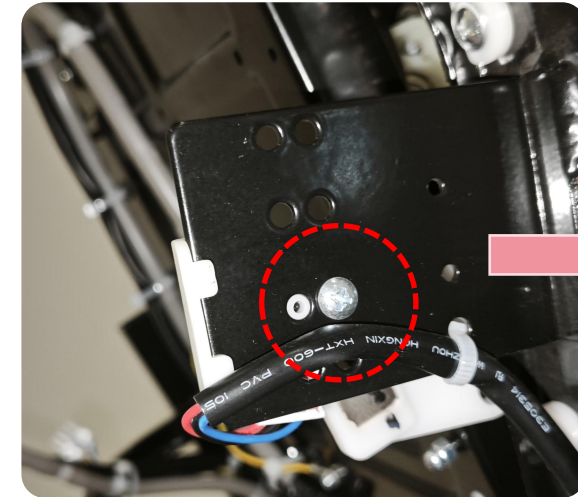
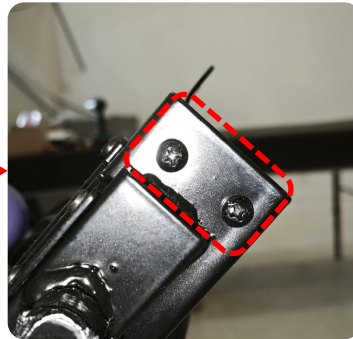
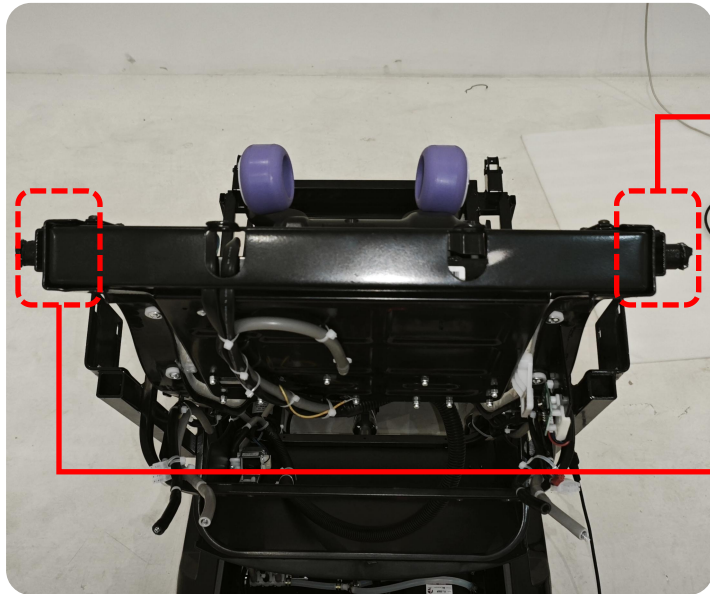

① Remove the fixing screws on both sides

Remove the metal frame bar

② Remove a fixing screw

3.6.1·Remove the mech

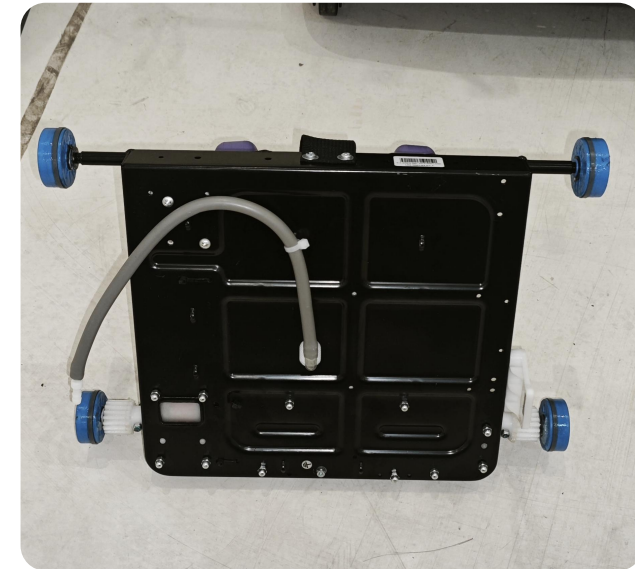
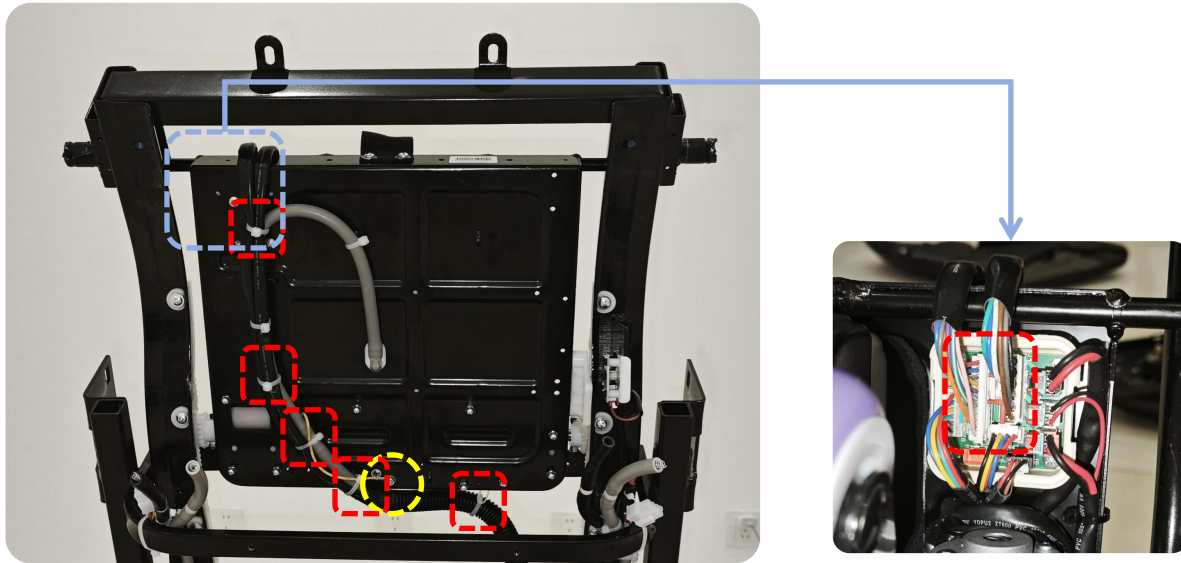

① Remove the ground wire screw, cut off the fixed cable ties, remove the connecting air pipe, unplug the connection terminals

Mech
assy

3.7.1·Remove the power box

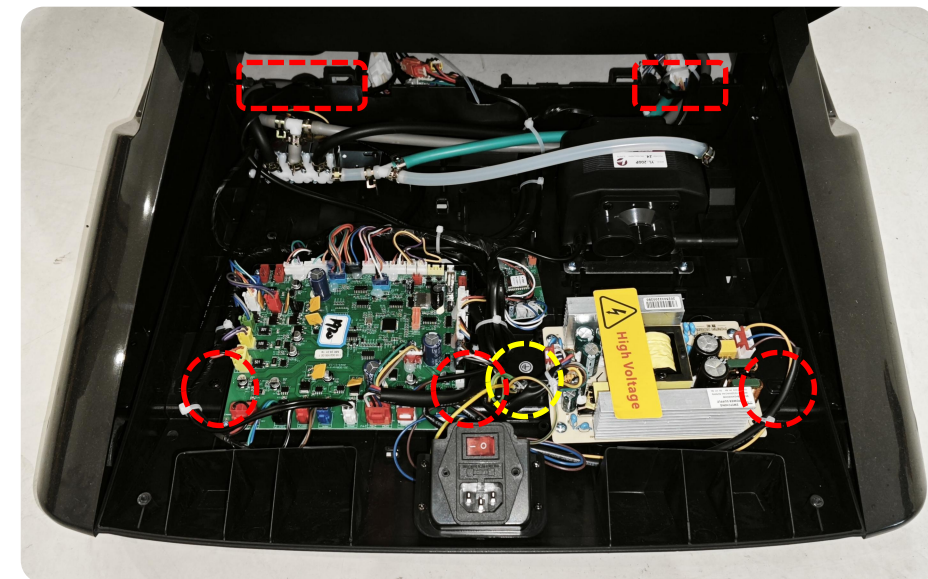
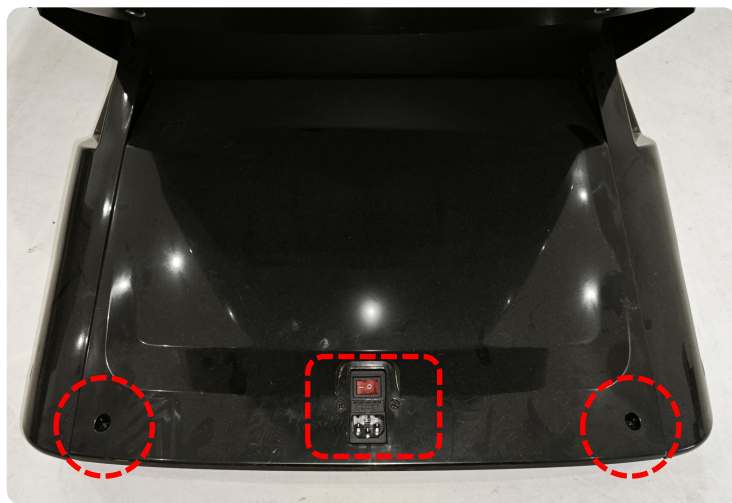

Screws
type

① Remove the
fixing screws



Upper cover of
power box

② Remove the fixing
screws, unplug the
connecting air pipes &
terminals

3.7.1·Remove the power box

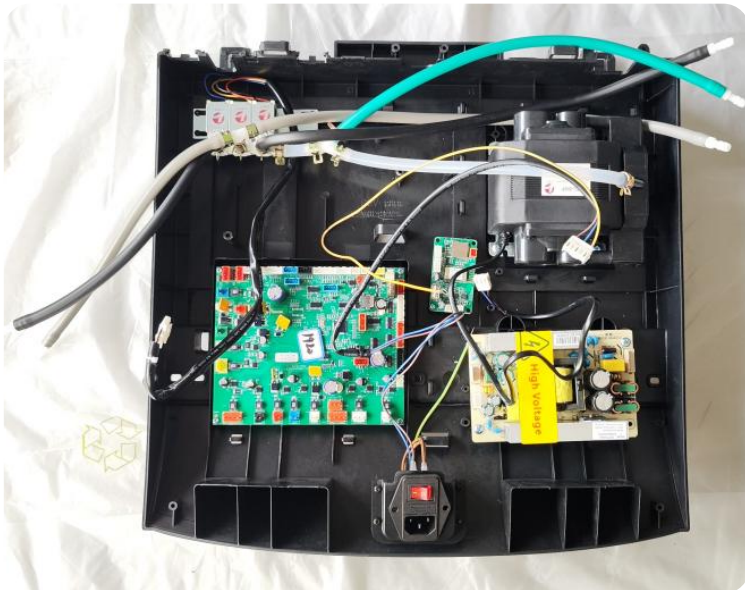

Power box assy

3.8.1·Remove the side panel

Front Middle Back



Screws type

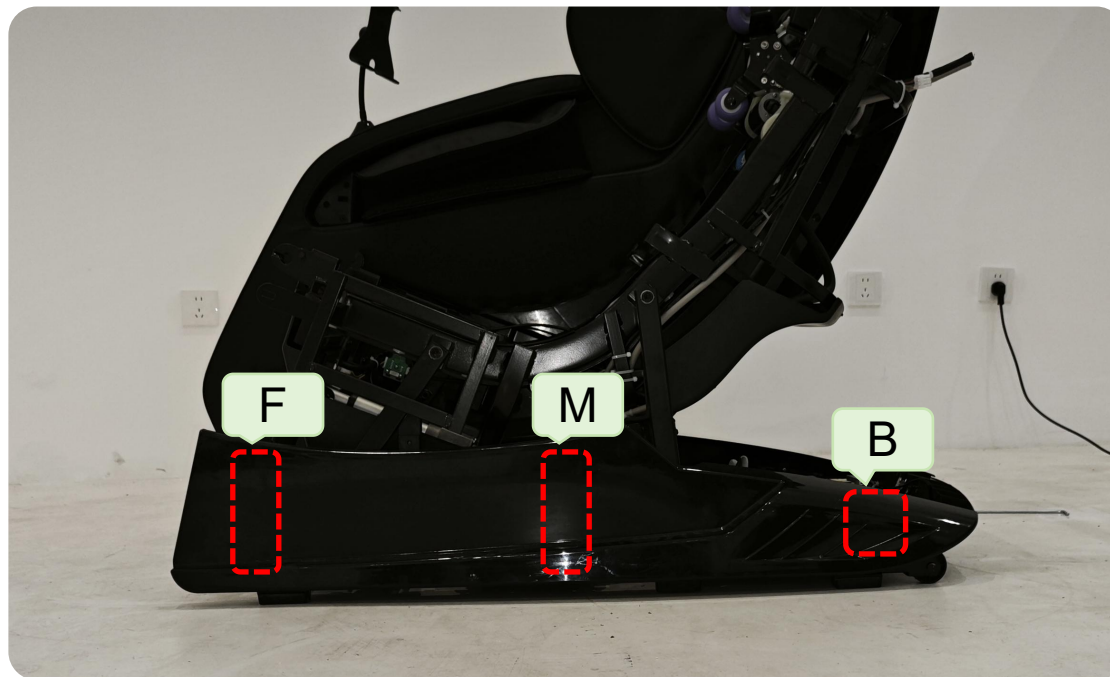

① Remove the fixing screws



Lower side panel

3.9.1·Remove the actuator

Remove the footrest actuator

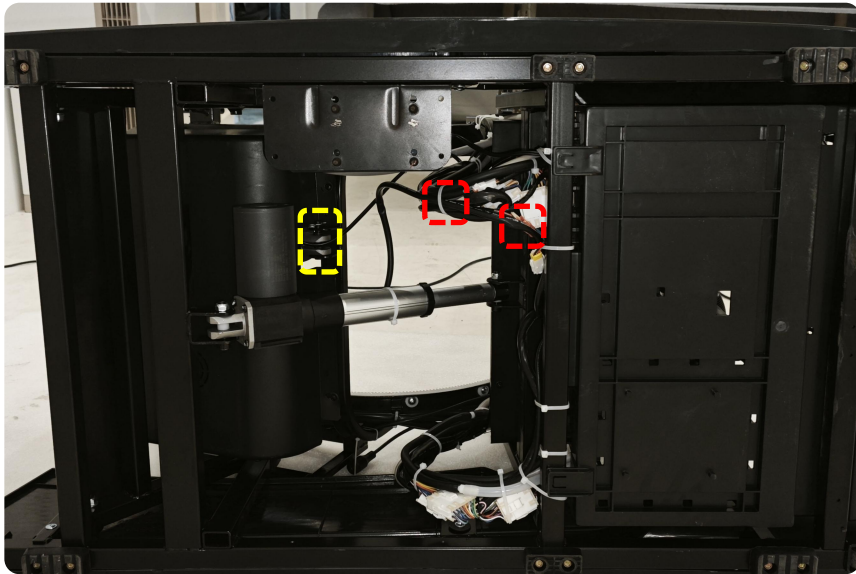

① Cut off the fixed cable ties & remove the connection terminals of the actuator, remove the fixing pin of the actuator.

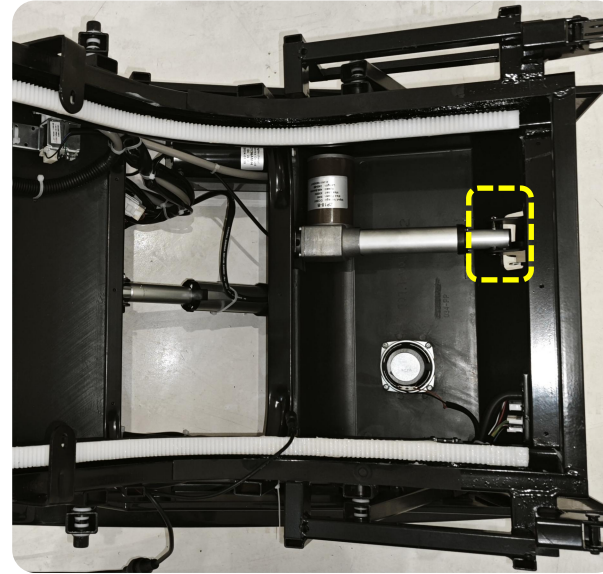

② Remove the pin of the actuator, then remove the actuator.



Footrest
actuator

3.9.1·Remove the actuator

**Remove the
backrest actuator**

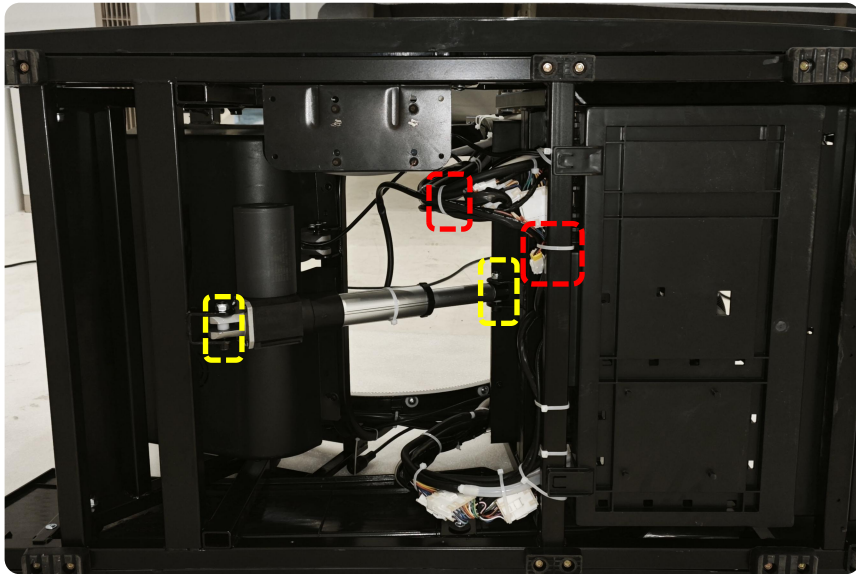

① Cut off the fixed cable ties & remove the connection terminals of the actuator, remove the fixing pin of the actuator.



Backrest
actuator

4. Analysis and Repair of Massage Chair Faults

1. The whole chair is not working.
2. Kneading and Knocking do not work.
3. The mech cannot move up and down.
4. The backrest or the footrest actuator does not rise or down.
5. The roller of the foot do not work.
6. The backrest or foot heat therapy doesn't work.
7. No music function.
8. A certain group of air pressures is not working.

4.1.1·Analysis and Repair of Massage Chair Faults

The whole chair is not working

1. The tablet is damaged, can't start up. The method of replacing the tablet is adopted.(Pic1)

①



Analysis

2. Check if the main switch is on and inspect if the fuse is blown. Generally, it is caused by a short circuit in the main PCB or power switch board. Replace the main PCB & fuse (Pic2)

②

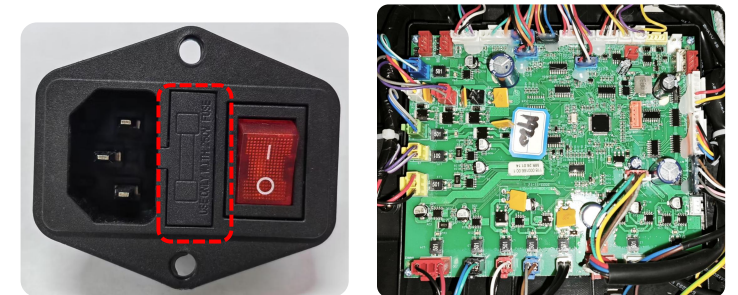

3. Check the power board to see if there is a 120V input & a 5V output. Replace the power board if there is no 5V voltage, & replace the main board(Pic3)

③



4.2.1·Analysis and Repair of Massage Chair Faults

Kneading and Knocking do not work.

1. First, check if there is poor contact in each harness plug-in from the PCB to the kneading motor and whether there is voltage output(Pic1)

①

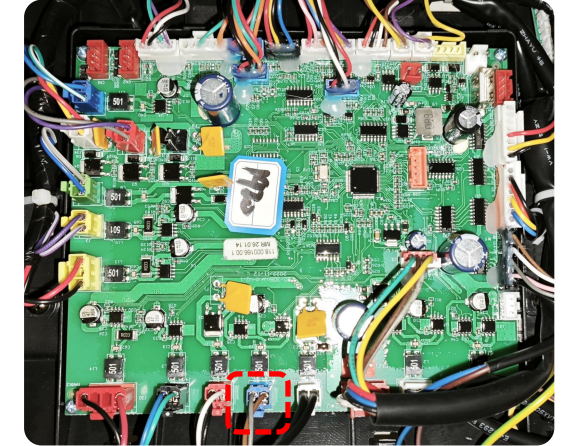

Analysis

2. Remove the back cover and measure if there is voltage in the plug on the back cover of the mech(Pic2). If there is voltage, it indicates that the motor is damaged. There is no problem with the voltage harness or the board type.

②

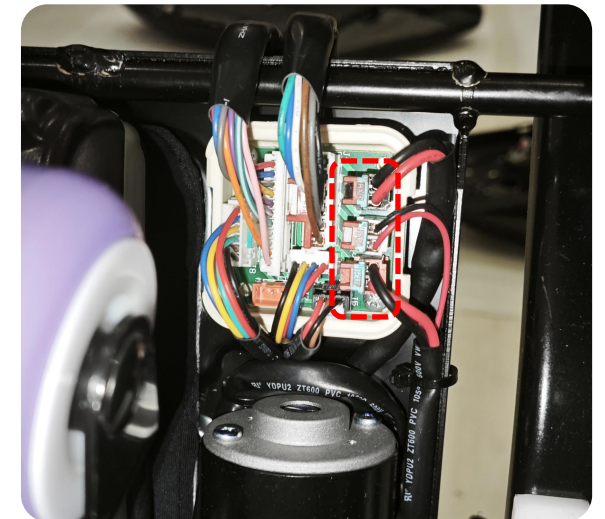

3. In the absence of a multimeter, the condition of the motor can be confirmed by substitution (by interchanging the kneading and knocking plugs).

4.3.1·Analysis and Repair of Massage Chair Faults

The mech can't move up and down.

Analysis

1. First confirm and check whether there is any poor link or loose plug-in in the harness.

2. To determine whether a motor is damaged, you can use tapping the power supply of the motor to judge its condition (Pic1).

3. Determine whether the upper and lower limit detection plates are damaged(Pic 2).

4. In the absence of a multimeter, the condition of the motor can be confirmed by substitution (by interchanging the walking and kneading or tapping plug).

5. Measure whether there is an AC24V output at the PCB terminals and whether the PCB is damaged (Pic3).

①

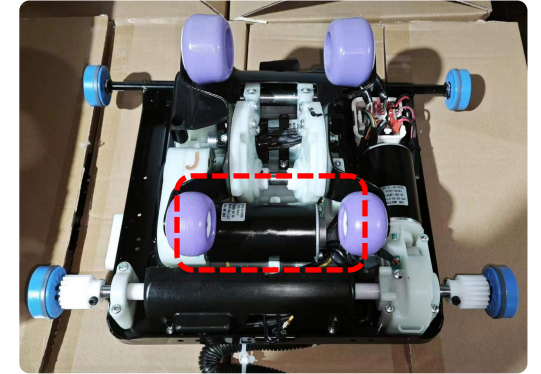

②

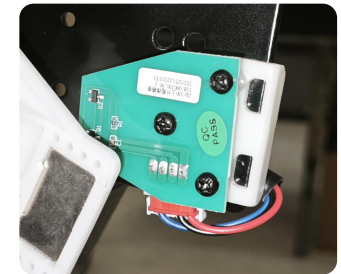

③

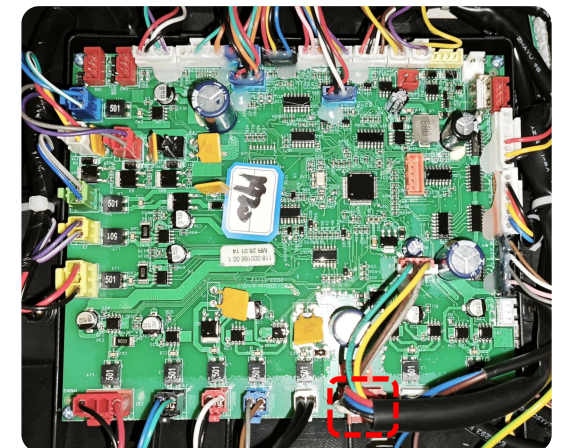

4.4.1·Analysis and Repair of Massage Chair Faults

The backrest or the footrest actuator does not rise or down.

1. First confirm and check whether there is any poor link or loose plug-in in the harness.(Pic1)

①

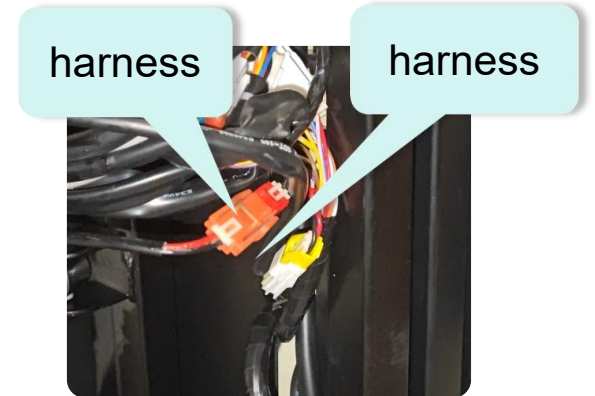

Analysis

2. Use a multimeter to measure whether there is voltage output from the PCB.If there is no voltage output,replace the PCB(Pic2).

②

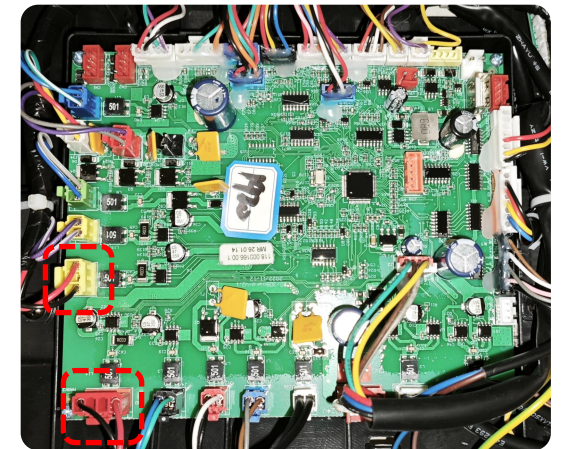

3. First, hold down the actuator lying button and listen to the "beep, beep," sound from the tablet.Then check if the chair moves up or down to determine if the actuator is faulty and replace it.

4.5.1·Analysis and Repair of Massage Chair Faults

The roller of the foot do not work.

Analysis

1. First,check if there is any poor link or loose plug-in in the wiring harness.(Pic 1)

2. Use a multimeter to measure whether there is a DC24V at the terminal (Pic 1).If there is no voltage,it indicates that the PCB and harness are damaged and need to be replaced.If there is voltage,it indicates an internal fault in the leg.

3. Disassemble the leg to check if the terminals of the harness have come off.If they have, just reinsert them properly (Pic2).

4. If the foot adapter is in good condition and the harness is normal,it can be determined that the roller motor is damaged and needs to be replaced (Pic 3).

①

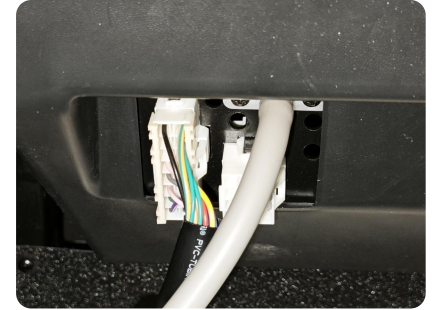

②

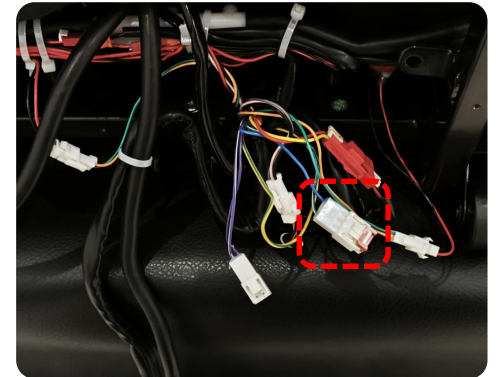

③

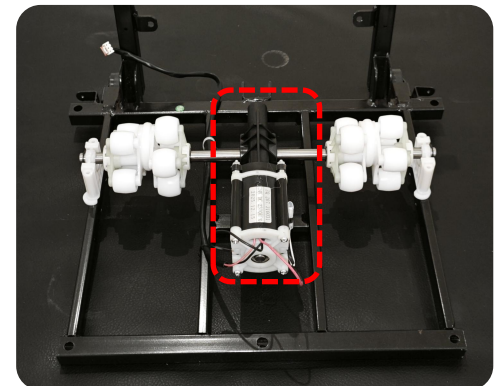

4.6.1 Analysis and Repair of Massage Chair Faults

The backrest or foot heat therapy doesn't work.

Analysis

1. Check if there is poor link or detachment at the terminal of the heating wire on the backrest (Pic 1)

①

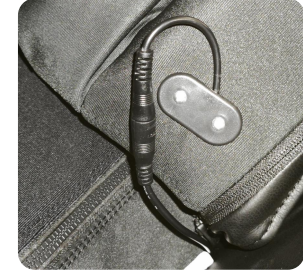

2. Use a multimeter to measure whether there is AC24V at the terminals of the PCB. If there is damage to the PCB, replace it (Pic 2)

②

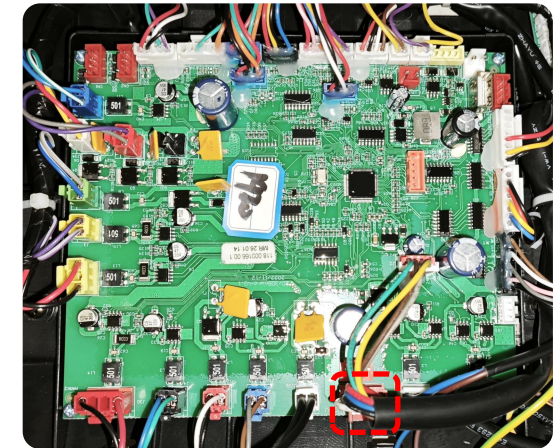

3. Use a multimeter to measure whether there is AC24V at the terminals of the PCB. If there is a voltage output, check the harness. If the communication of the harness is normal, replace the heating plate (Pic 3)

③

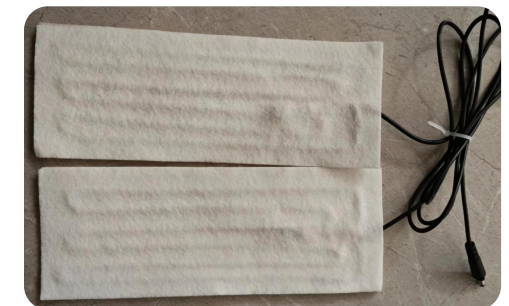

4.7.1·Analysis and Repair of Massage Chair Faults

No music function

Analysis

1. Phones can't find the bluetooth name after the chair on:
A. check that the tablet bluetooth switch is on (Pic 1)
B. to turn off the power to search again after waiting for 3 to 5 minutes, still can't search to replace the bluetooth PCB.

2. Phone is successfully paired with bluetooth. Check whether the contact of the bluetooth PCB harness is normal. If not, replace the bluetooth PCB (Pic 2)

3. Check whether the cable from the Bluetooth PCB to the speaker is in poor link.

4. If one side of the speaker does not sound, check the harness and replace the speaker (Pic 3)

①

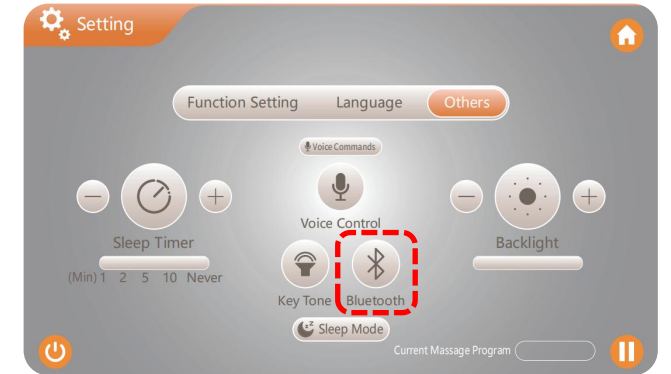

②



③

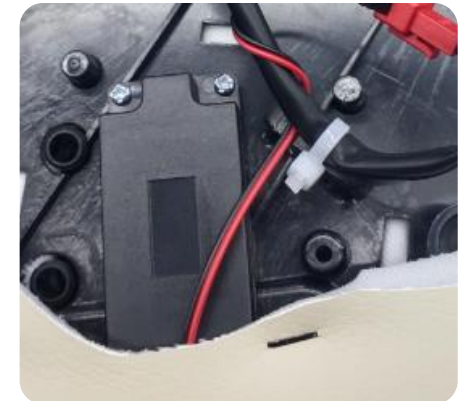

4.8.1·Analysis and Repair of Massage Chair Faults

A certain group of air pressures is not working

Analysis

1. Check whether the air bag of this way is cracked and whether the air pipe is bent (Pic 1)

2. Check whether the air valve controlling the air pressure of this circuit is damaged (Pic 2)

3. Use a multimeter to measure whether the terminal voltage of the PCB is output. If there is no voltage output, replace the PCB (Pic 3)

①

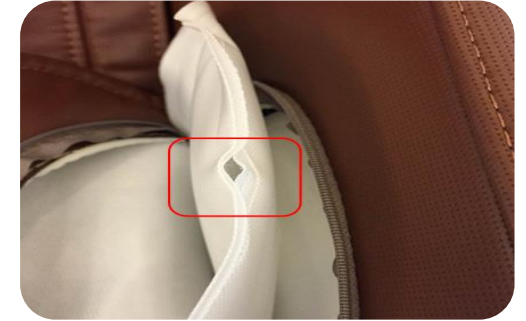

②

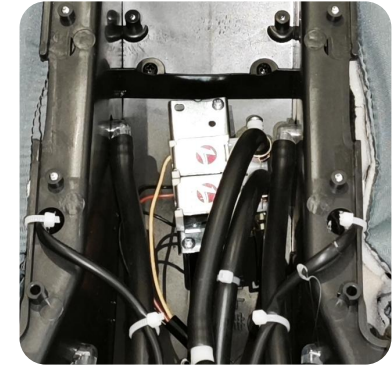

③

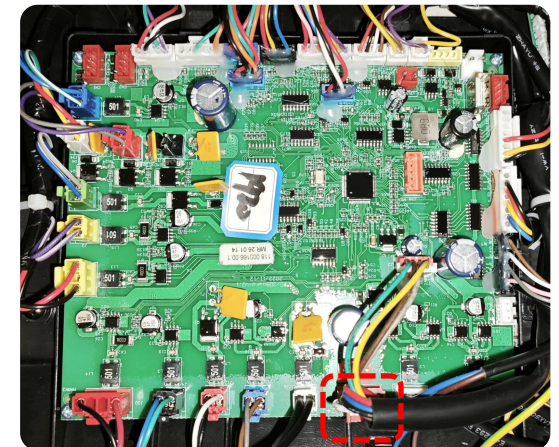

5.Tool list

							
Multimeter	Test pen	Hex wrench	Nipper pliers	Rubber tape	Cable tie	Vice jaw	Electric drill

Thank you

Service Dept.

