



EASEPAL. 厦门蒙发利电子有限公司客户服务部

EC-7513A massage chair service guide

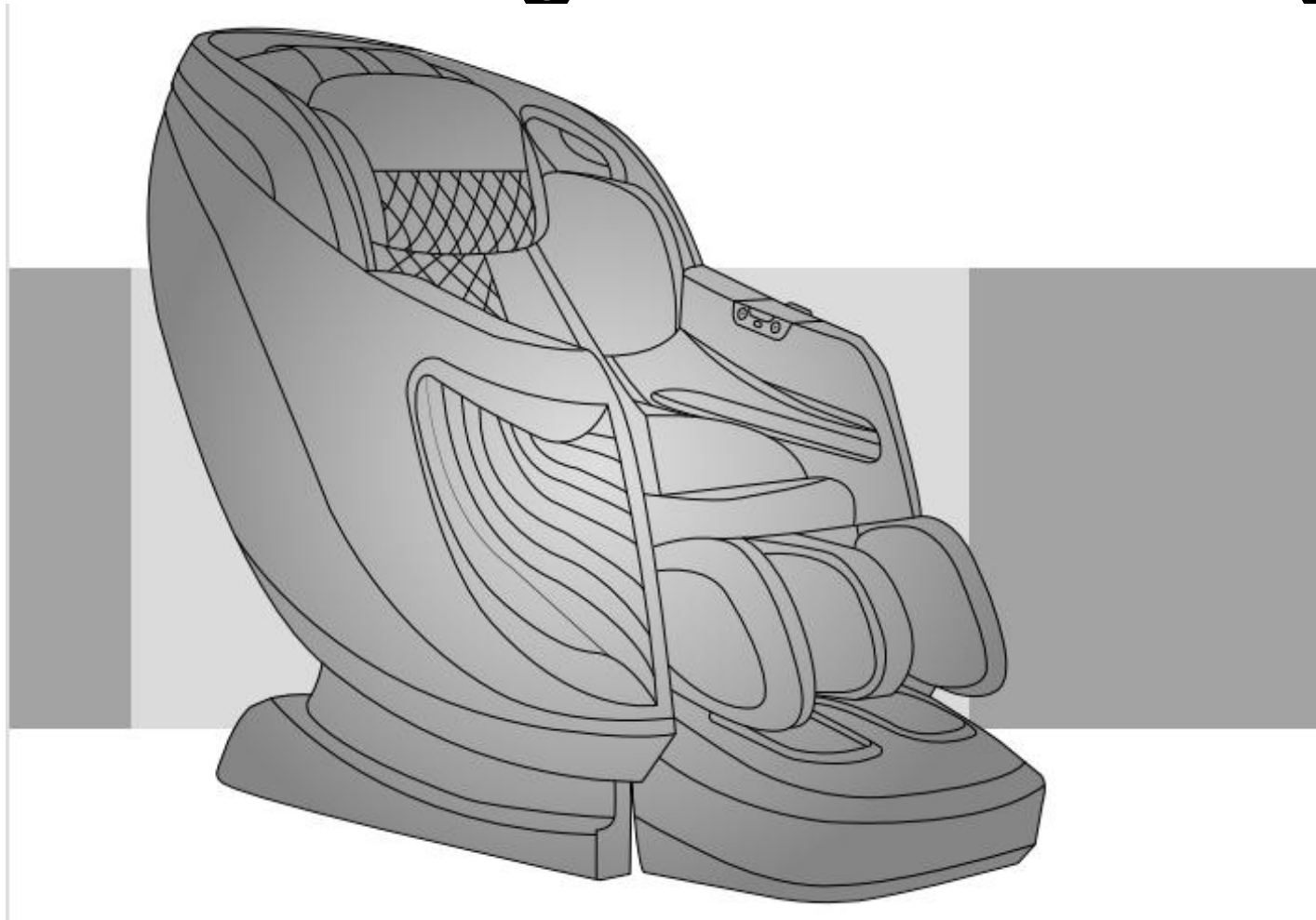



Table of Contents

- 一、 Product introduction**
- 二、 Massage chair tools and use**
- 三、 Circuit working principle**
- 四、 Massage chair removal instructions**
- 五、 Massage chair fault judgment**



EASEPAL

厦门蒙发利电子有限公司客户服务部

一、Product introduction

Front

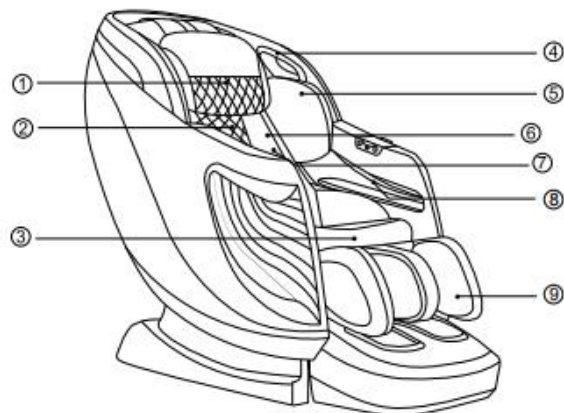

- | | |
|---------------------------|---------------------------------|
| ① Pillow Pad | ⑤ Shoulder side massage section |
| ② Backrest Pad | ⑥ 3D heating section |
| ③ Seat Cushion | ⑦ Waist massage section |
| ④ Bluetooth Music Speaker | ⑧ Hand and arm massage section |
| Bluetooth Speaker | ⑨ Legrest |

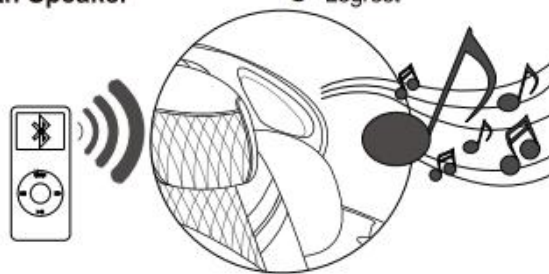

NOTE:

The bluetooth speaker can only connect with one bluetooth device at a time. Please turn off your bluetooth device after using so that other users can enjoy it as well.



一、 Product introduction

Description	Specifications
Model No.	Osaki Pro OS-3D Opulent
Rated Voltage	110-120V~
Rated Frequency	60Hz
Rated Power Consumption	145W
Rated Time	15 minutes
Dimensions(L x W x H)	Upright: 64.2" x 29.7" x 50.2"
	Reclined: 76.5" x 29.7" x 39.3"
Weight	Gross Weight: Approx 276.1lbs
	Net Weight: Approx 239.9lbs
Length of Wire	Controller wire: 59.0"
	Power supply wire: 70.9"
Usage Condition	Environment temperature: 32°F~95°F
	Contrasting humidity: 20-80RH
Storage Condition	Storage temperature: 23°F~95°F
	Storage humidity: 20-80RH
Safety Feature	Equipped with overheated and power
Maximum body weight of user	220 lbs



EASEPAL

厦门蒙发利电子有限公司客户服务部

二、Massage chair tools and use

1.tools

					
Screwdriver size 1,2,3	Diagonal cutter and long nose pliers	Soldering Kit	Spanner tools Kit	Test pen	Allen Key set
					
Ratchet Tools Set	24V/DC power	Electric Driver	electrical adhesive tape	Cable Ties	WIRE ONECTORS



2.Usage of multimeter

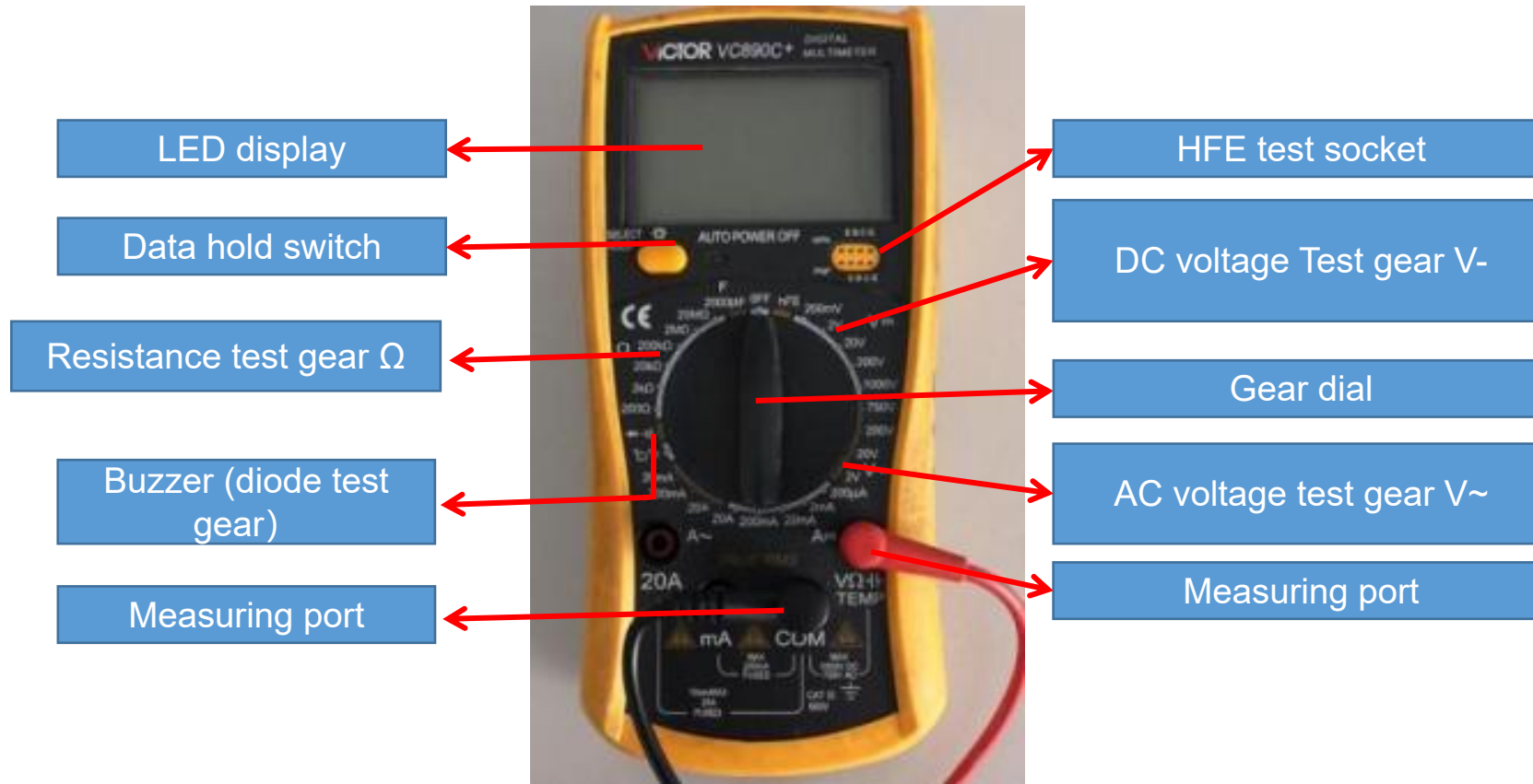



2.1、 Function of the test gears

Data hold switch: Memorize the measured data for comparison.

Buzzer (diode test gear) : Measure the quality of diode, the on-off and alarm function of circuit

Resistance gear test gear: Measure the quality and value of resistance

DC voltage Test gear V-: Measure DC voltage

AC voltage test gear V~: Measure AC voltage

VΩ / COM: VΩ Red pen port (+ pole) during test, black pen port (- pole) during com test

Note: when carrying out resistance or voltage test, it is necessary to select a suitable range. If the range is too small to be measured, and the range is too large, the test error range is large; if the voltage is not known, it is necessary to select a range measurement with a large windlass.



2.2、 On / off measurement of lines



open circuit



As shown in the left picture, first set the multimeter to the buzzer and power it
When the switch is on, the multimeter will display "0."; then contact the two probes with the ends of the red wire
At this time, the multimeter still shows "1." there is no change, which means there is an open circuit in the middle of the wire, that is, the line is open.



close circuit



As shown in the picture on the left, if the multimeter shows the number of ". 002" or ". 00n" and gives an alarm, it means that the wire is connected.

2.3、 Measurement of AC voltage



As shown in the picture above: measure the household plug-in board power supply (220V), select the range of 750, and the test result shows "224", indicating that the actual voltage of this group of sockets is 224v at the moment (the switch is pressed down, so there is power, and the light is on).



As shown in the above picture: measure the power supply (220V) of our household plug-in board, select the range of 750, and the test result is displayed as "001", indicating that the actual voltage of this group of sockets is 0V at the moment (the switch is not pressed down, so there is no power, and the light is not on).

2.4、 Measurement of dc voltag



As shown in the figure above: the test result shows "1.58", indicating that the voltage at both ends of the battery has 1.58V, and the red watch pen is connected to the battery's "+" pole, while the black pen is connected to the electromagnetic "-" pole.



As shown in the figure above: the test result shows "-1.58", indicating that the voltage at both ends of the battery has 1.58V, and the red watch pen is connected to the battery "-" pole, and the black pen is connected to the electromagnetic "+" pole.



EASEPAL

厦门蒙发利电子有限公司客户服务部

三、Circuit working principle

1、main PCB:

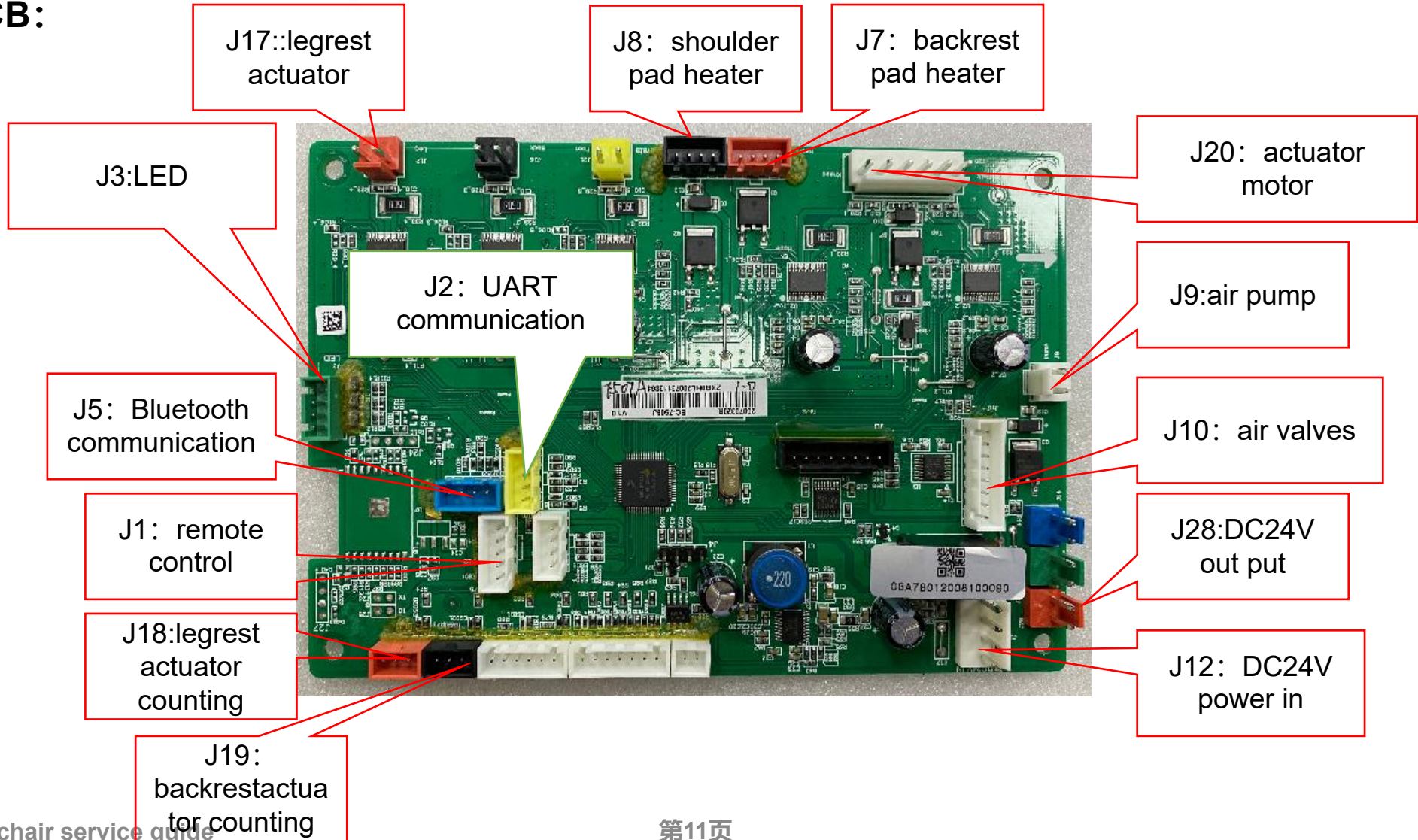



2、under seat PCB:

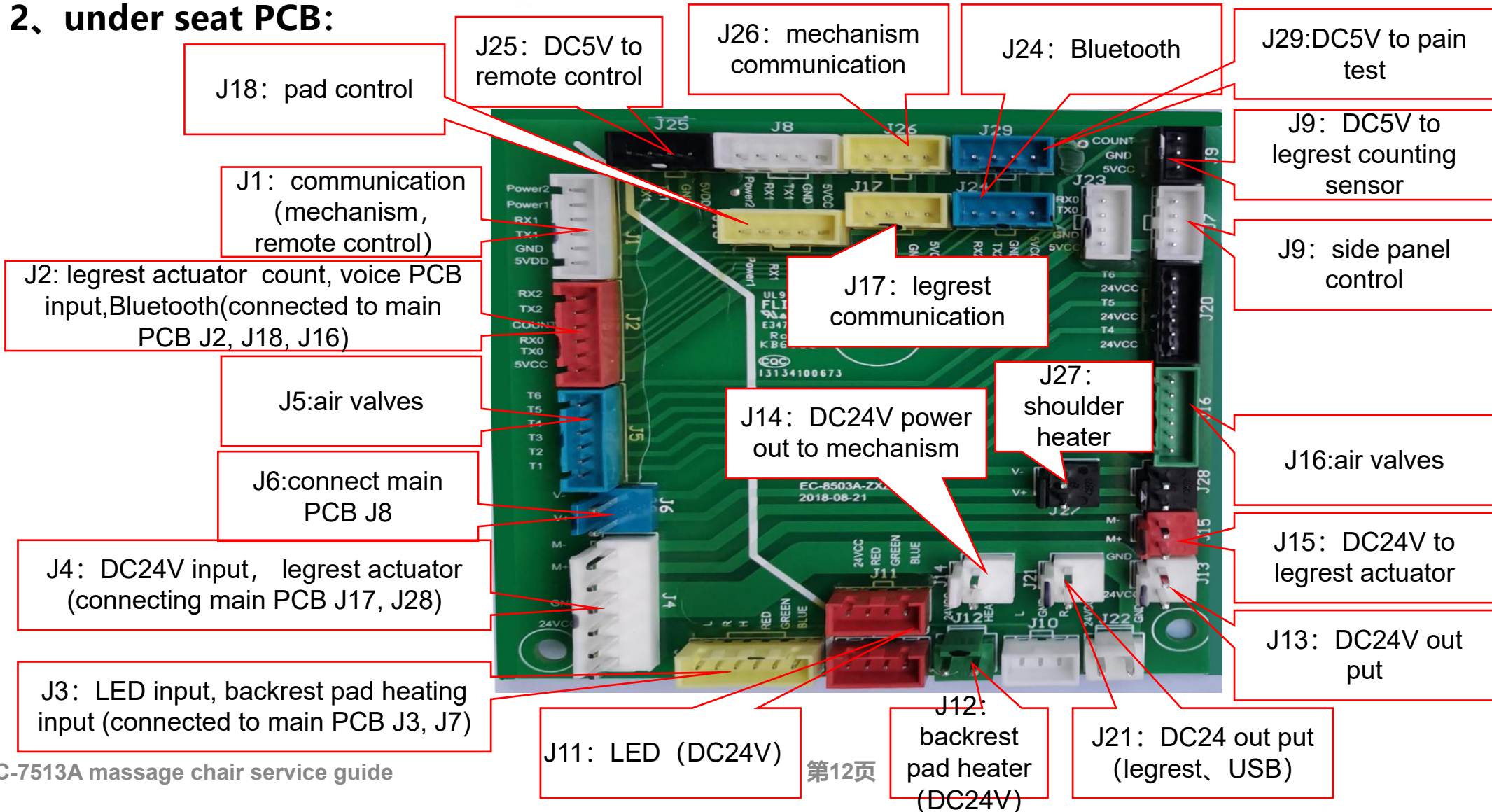



四、Massage chair removal instructions

1、main PCB box:

air pump



main PCB

power PCB

power switch



2、legrest:

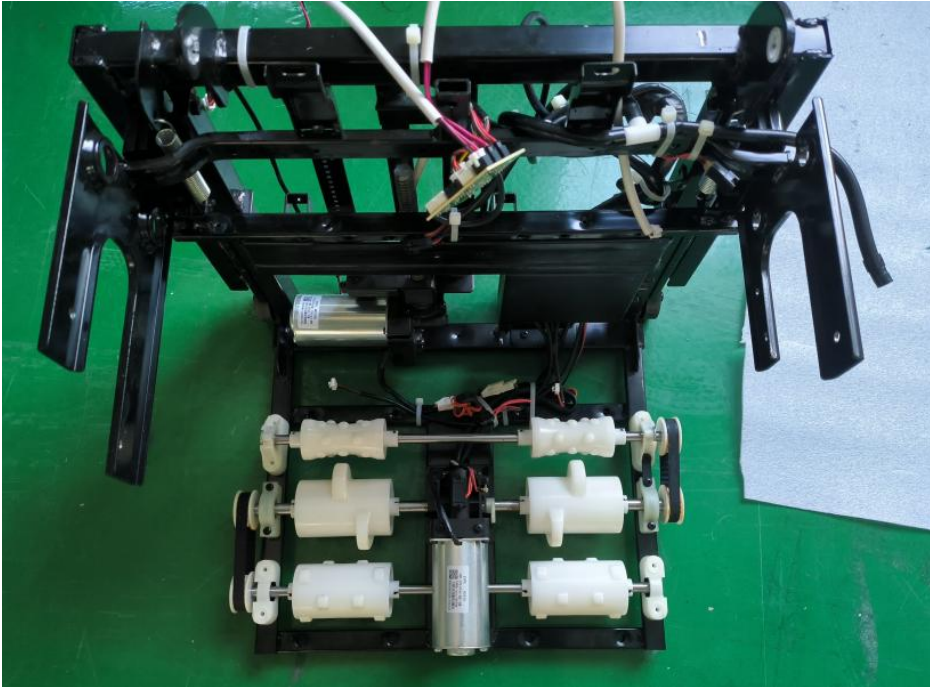

Iron frame of legrest



upper legrest



lower legrest



3.1、disassembly of the pillow



unzipper the zipper



remove the pillow



unzip the zipper



disconnected the terminal



remove the shoulder pad



3.2、disassembly of backrest pad



unzip the zipper



unzip the zipper



disconnected the terminal



unzip the zipper



backrest pad



EASEPAL

厦门蒙发利电子有限公司客户服务部

3.3、disassembly of the heater



unzip the zipper



discontent terminals, remove heater



heater



3.4、disassembly of side panel



unzip the zipper



remove 2 screws



remove 2 screws



remove 6 screws



remove the screw of right side panel

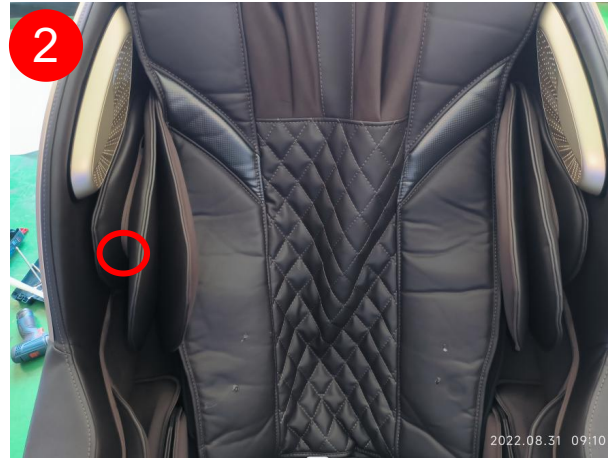

unzip the zipper



remove the screw



lift up side panel



cut cable, discontent terminal and air hose



remove right side panel assembly



remove the screw of right side panel



unzip the zipper



remove the screw



lift up side pane



cut cable, discontent terminal and air hose



remove left side panel assembly

3.5、disassembly of inner right side panel

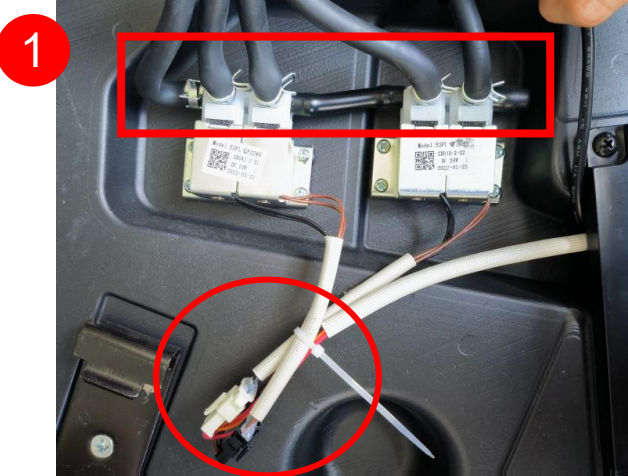

1
disconnected the terminal and air hose, remove 4 screws

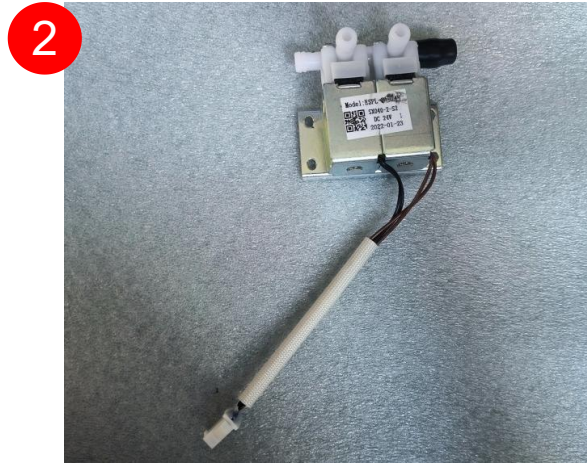

2
remove the air valve



3
remove the air valve



4
unzip the zipper



5
remove the arm cover



6
the air bag of arm



1 remove 4 screws

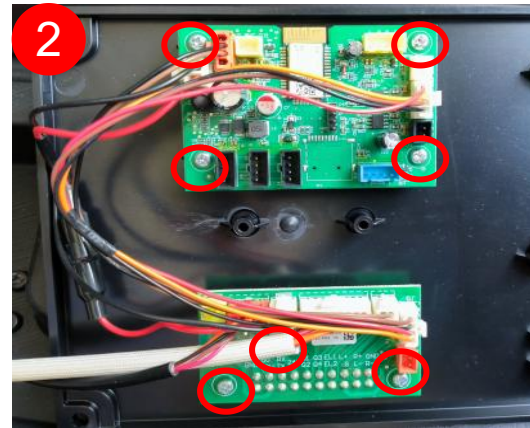

2 disconnected the terminals



3 disassemble Bluetooth PCB



4 disassemble adapter plate



5 Pry off the key board assembly along the edge



6 remove 4 screws



7 disconnected the terminal and remove the control



EASEPAL

厦门蒙发利电子有限公司客户服务部



bending a small cable tie



cable tie through hole position



Pulling out trim,remove 4 screws



open the horn box



horn

EC-7513A massage chair service guide



LED PCBA



3.6、disassembly of inner left side panel



position of the usb charge pcb

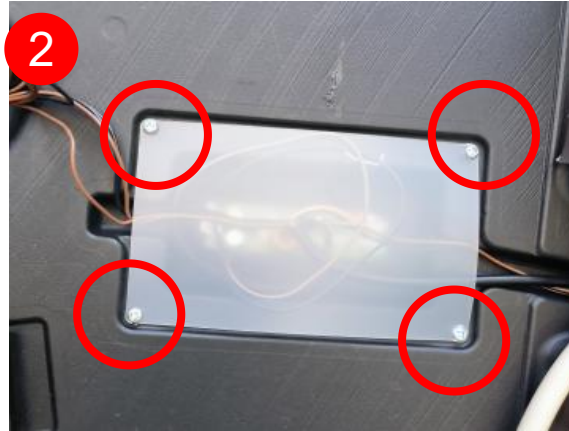

remove 4 screws

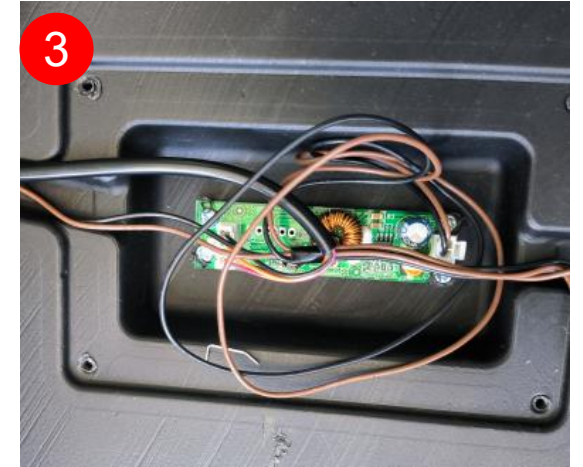

the USB charge pcb



remove the silicone pad



remove 4 screws



disconnected the terminal,
remove 2 screws



1
disconnected the terminal,
remove the USB base PCB



2
remove the veneer



3
remove 2 screws

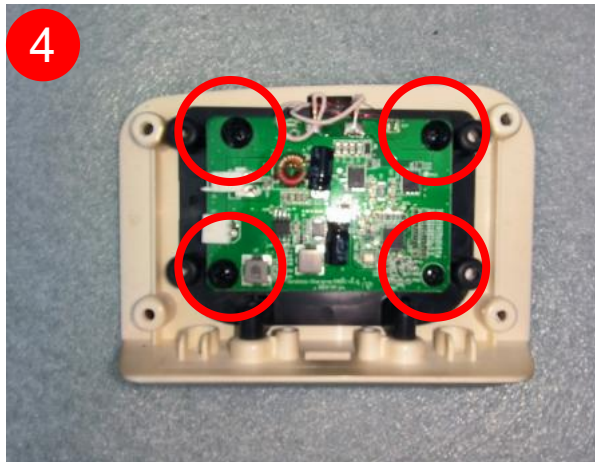

4
remove 4 screws

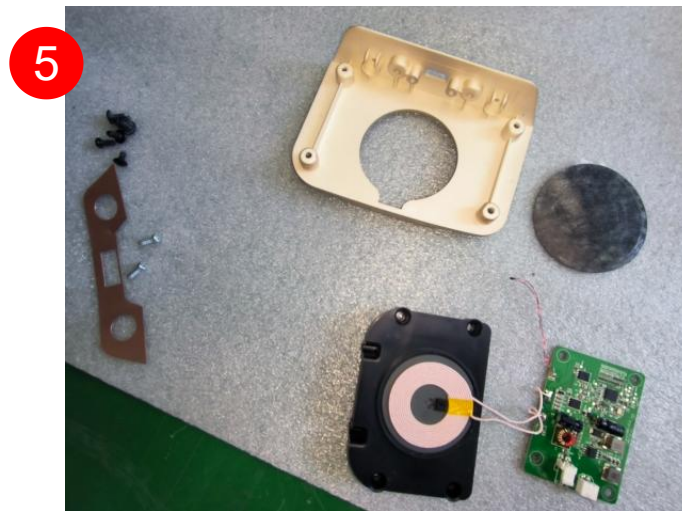

5
separate the wireless charging PCB

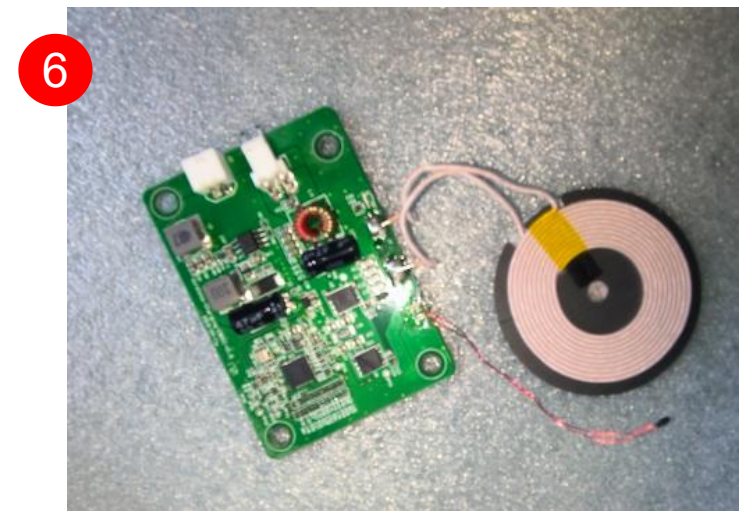

6
wireless charging PCB



3.7、disassembly of shoulder air bag



unzip zipper, discontent air hose



unzip zipper, discontent air hose



remove 4 screws, remove right shoulder unit

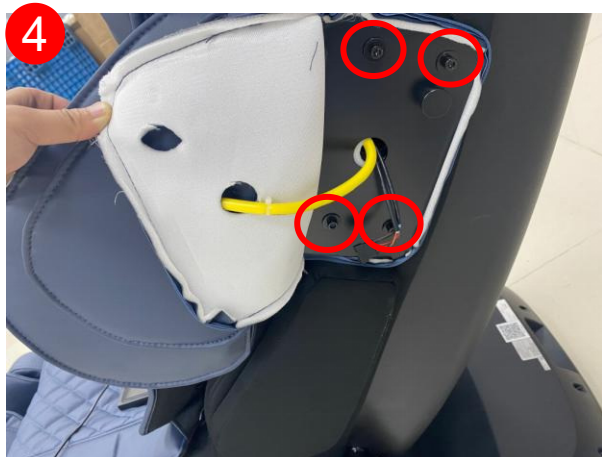

remove 4 screws, remove left shoulder unit



shoulder unit



remove the screws and remove air bag

3.8、disassembly of remote control



cut cable tie, discontent the terminal



remote control



3.9、disassembly of the side seat



disconnect air hose



remove 2 screws, remove left side seat



disconnect air hose



remove 2 screws, remove right side seat



open the cover



Remove the two flaps to replace the left and right side airbags and leather covers

3.10、disassembly of mechanism



remove rear cover

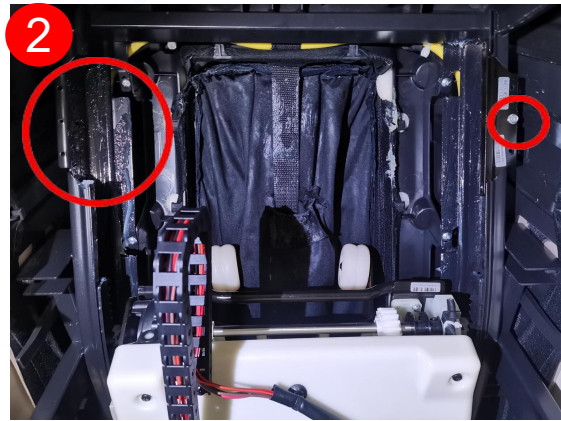

move down mechanism
Remove the one flap (Leave a screw fixing the flap here)

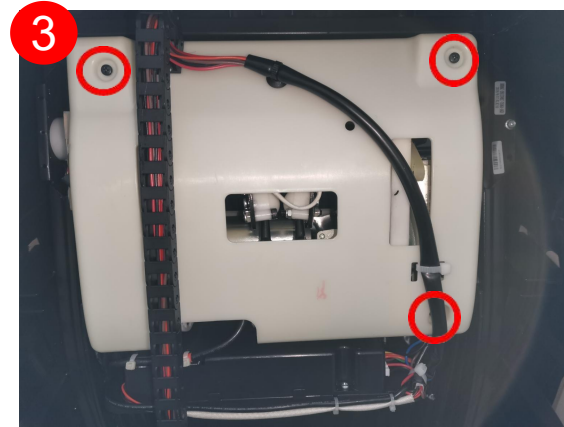

move mechanism to Topmost, remove the 3D movement cover

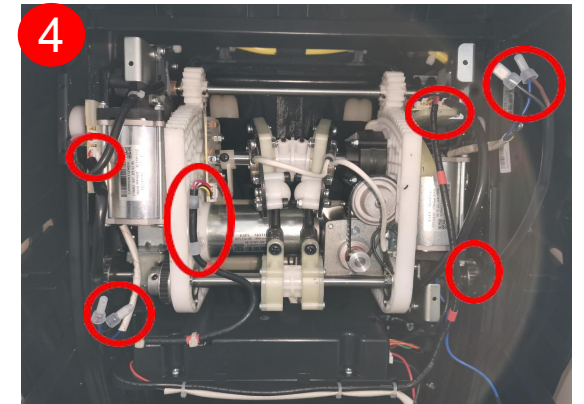

discontnet the terminals

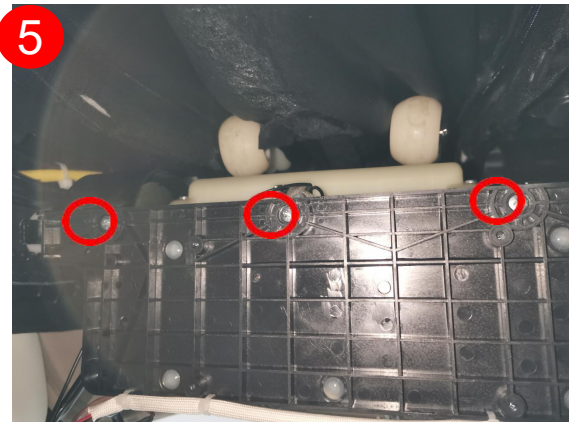

remove 3 screws



cut the heat shrinkable sleeve

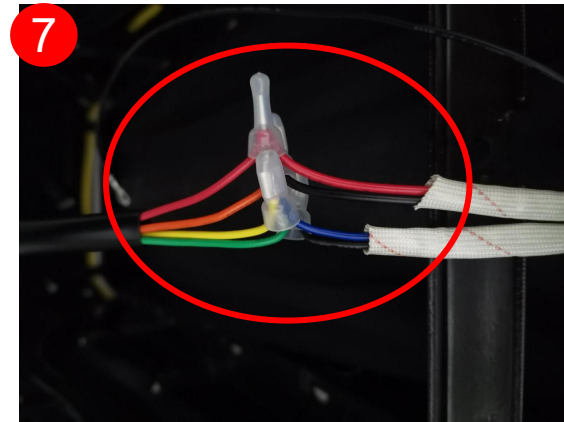

discontnet the terminals

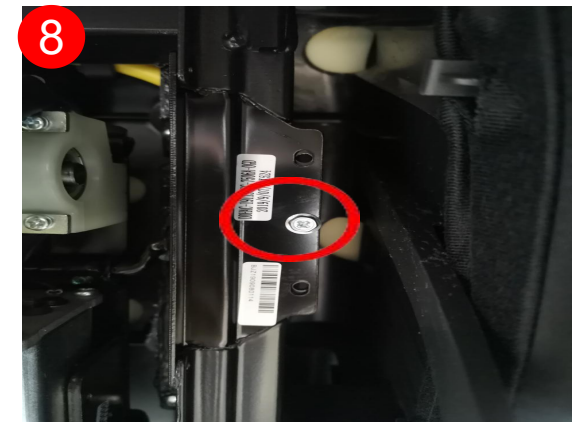

Press the movement, remove one screw 1, remove the right baffle (pay attention to the movement falling) and take out the movement assembly



4.0、disassembly of backrest cable



remove rear cover

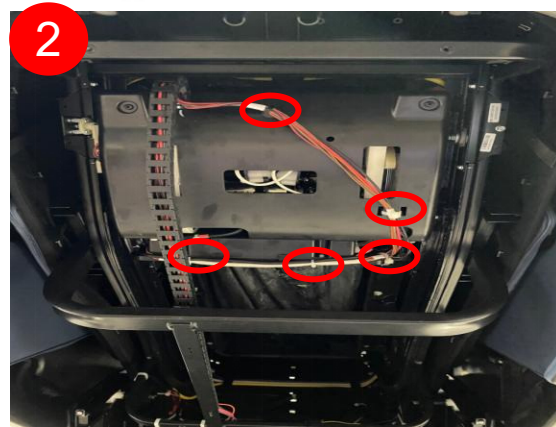

cut 5 cable tie

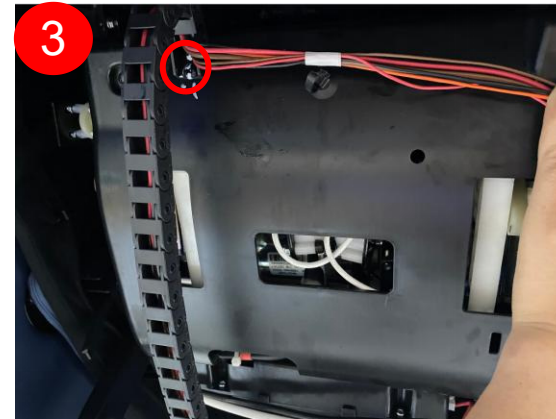

remove 2 screws

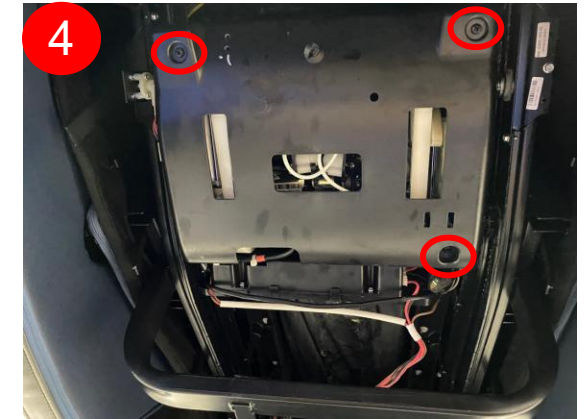

remove 3 screws and cover

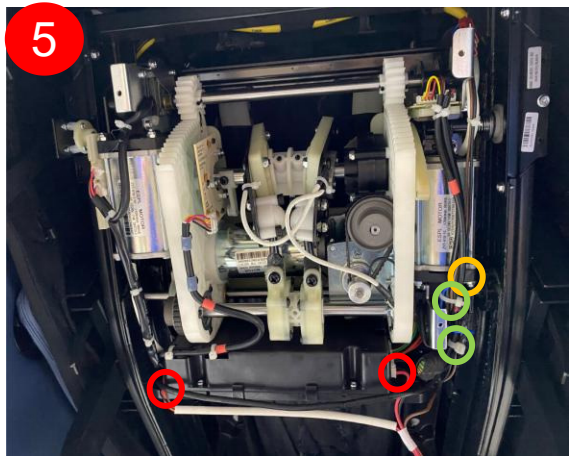

Pull out the red marked terminal, cut off the green marked buckle, and remove the Yellow marked ground screw
EC-7513A massage chair service guide

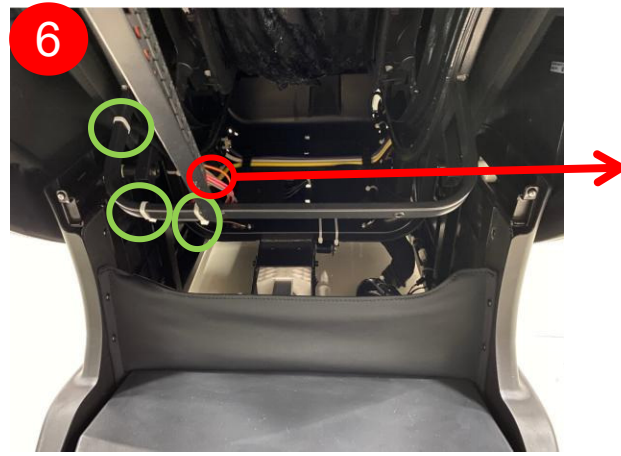

Cut off the buckle marked in green and remove the two screws marked in red

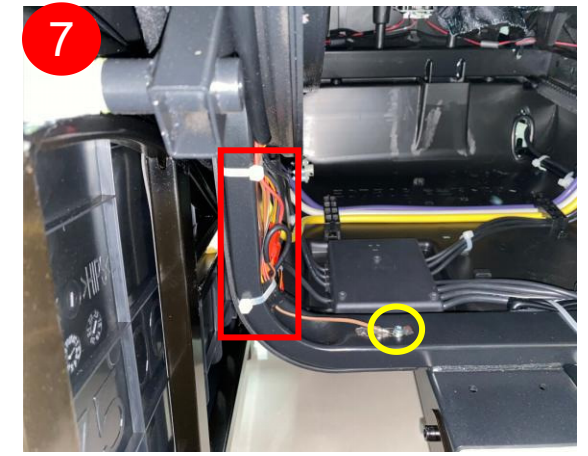

Cut off the buckle, pull out the terminal (marked in red), remove the ground screw marked in yellow, and take out the back strapping



4.1、disassembly of 3D PCB



remove rear cover

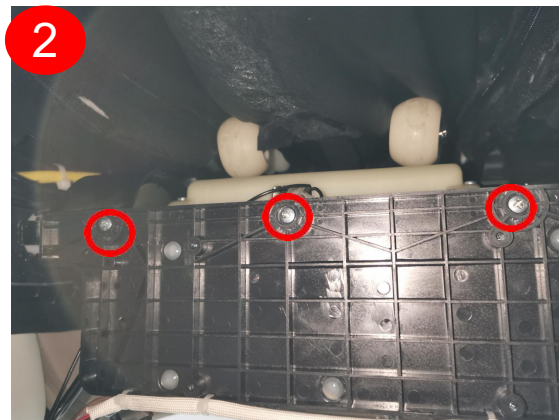

remove 3 screws



cut cable tie



remove the cover

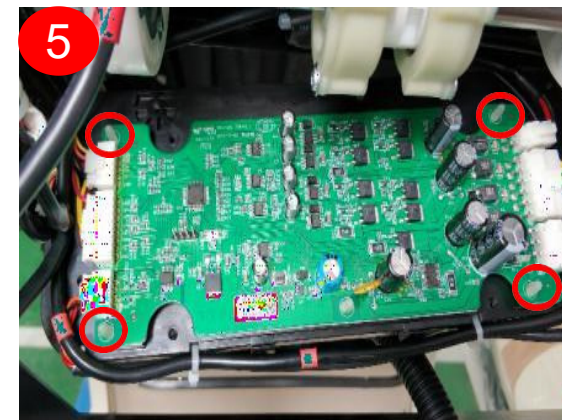

remove 3D PCB



4.2、disassembly of under seat PCB



remove rear cover

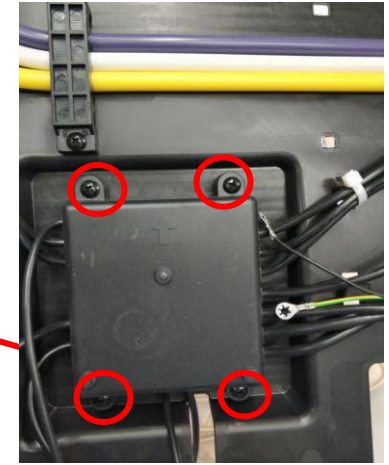
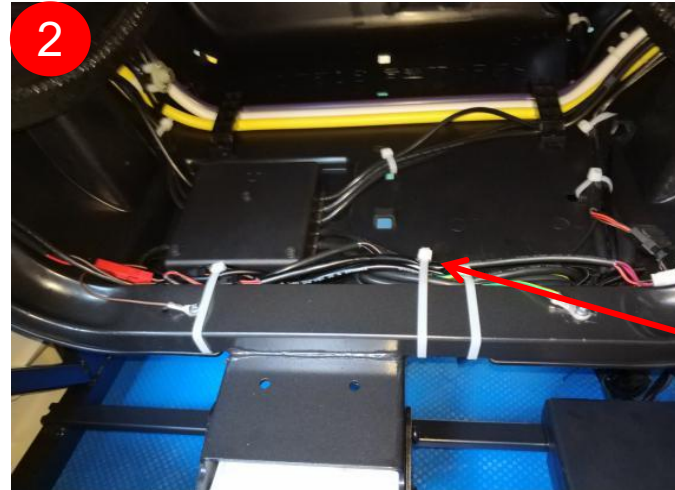

remove 4 screws and take down the cover

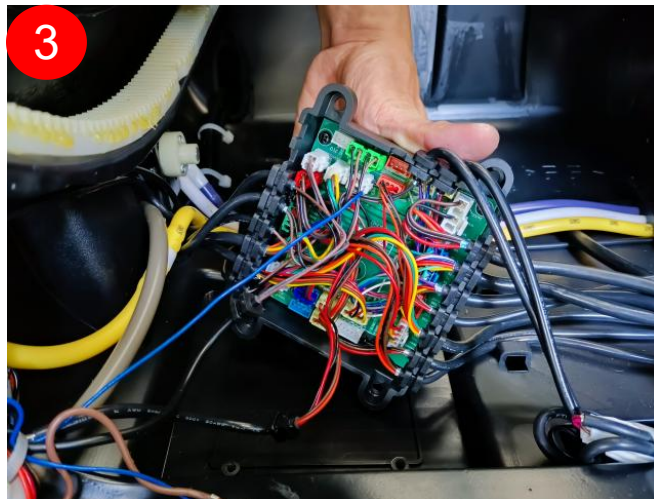

discontent all terminals

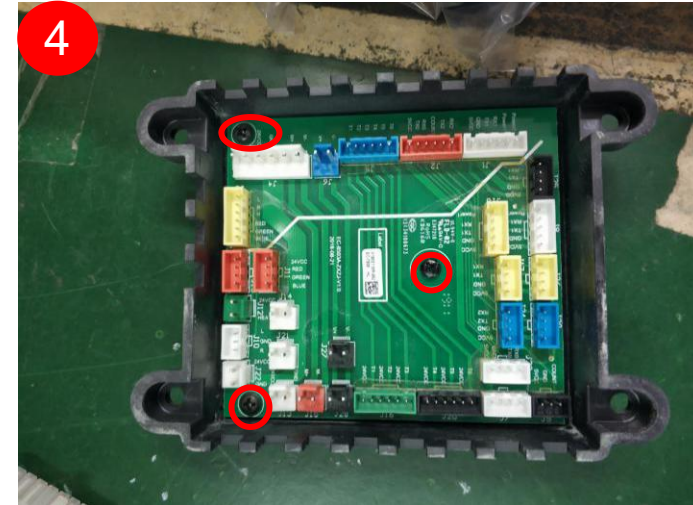

remove 3 screws and remove the PCB



4.3、disassembly of inner main PCB box



disassemble the cloth block

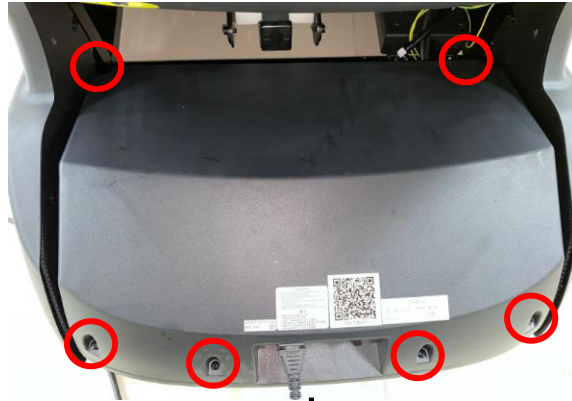

remove the cover

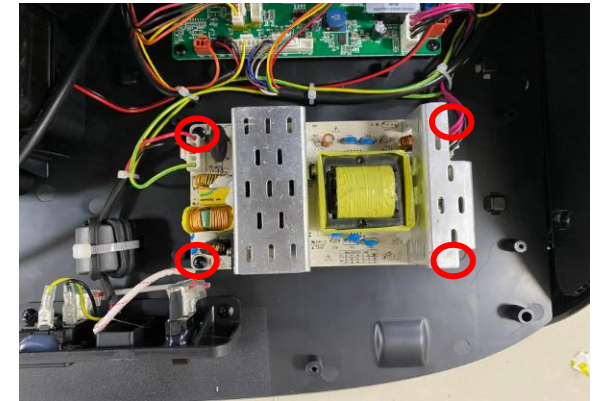

disassemble power PCB

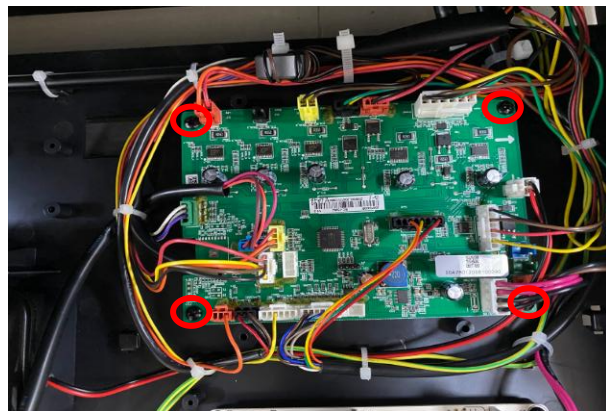

disassemble main PCB

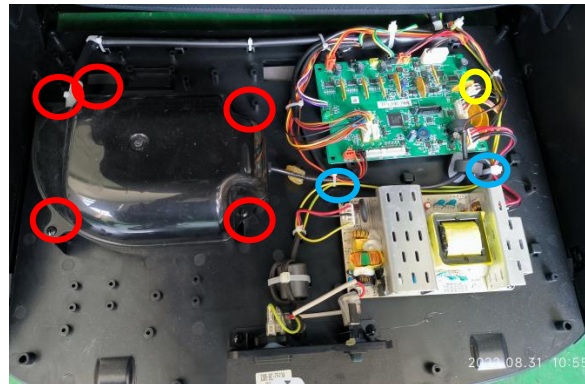

remove the cover nad
discontent terminal

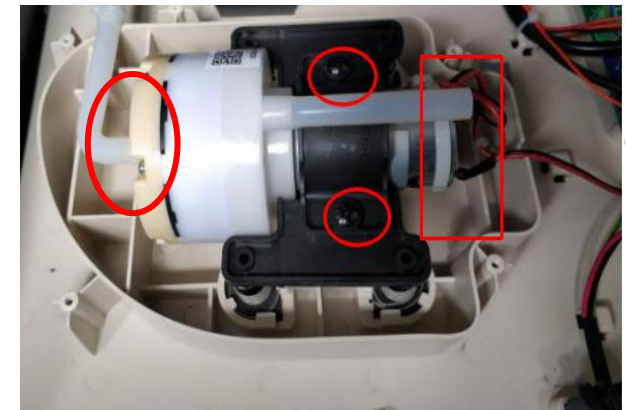

remove 2 screws, cut cable
tie, remove air pump



4.4、disassembly of legrest unit



unzip the zipper



remove the stopper



Remove the legrest in the direction of the arrow



disconnected the terminal and air hose, remove the legrest



4.5、Disassembly of upper leg assembly

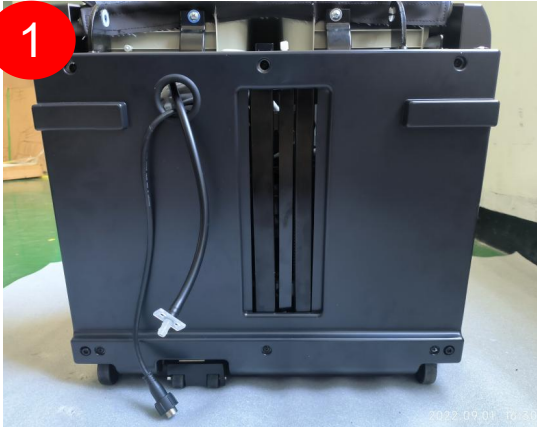

remove 6 screws

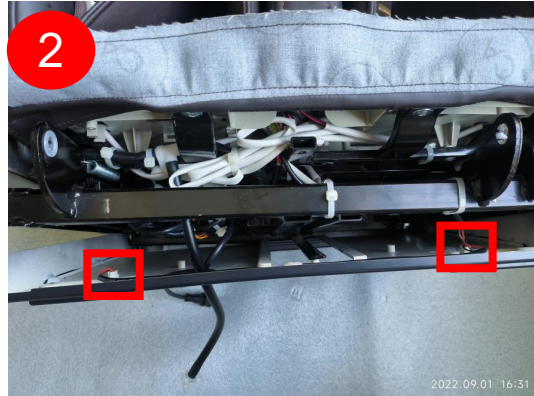

disconnected 2 terminals



rear cover

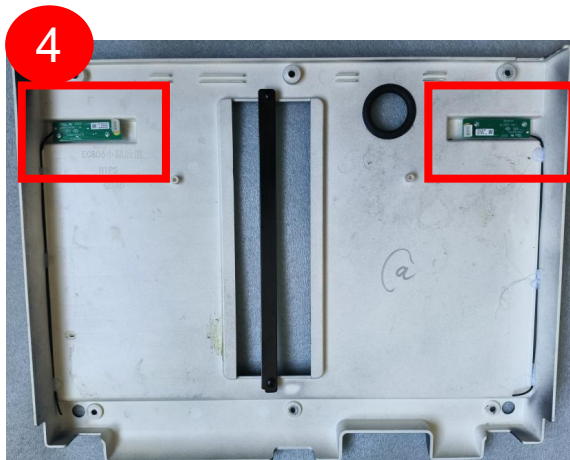

Anti pinch PCB



remove 2 screws

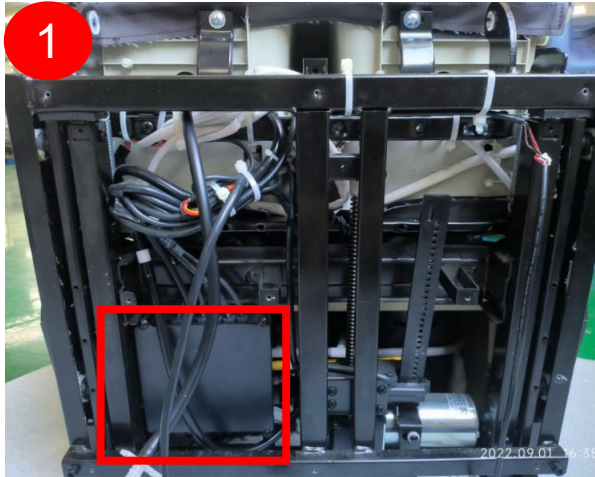

1
position of legrest PCB

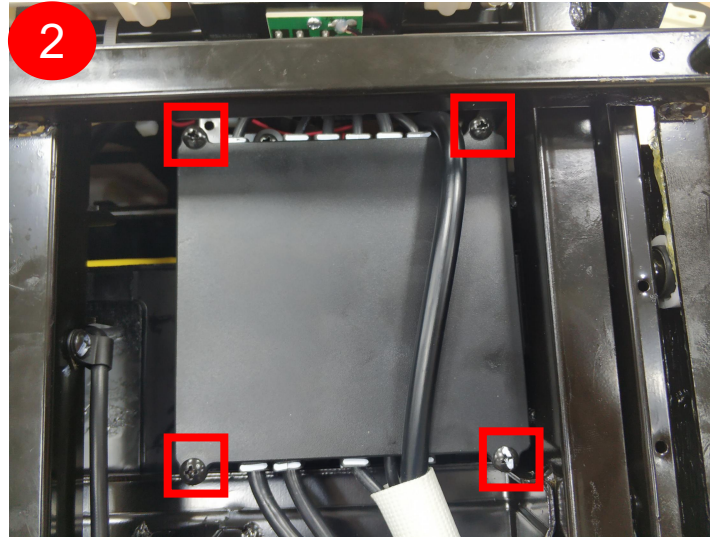

2
remove 4 screws

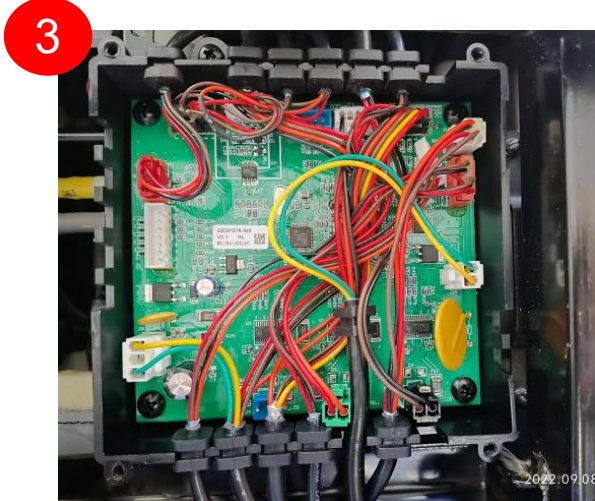

3
disconnect all terminals, remove 4 screws

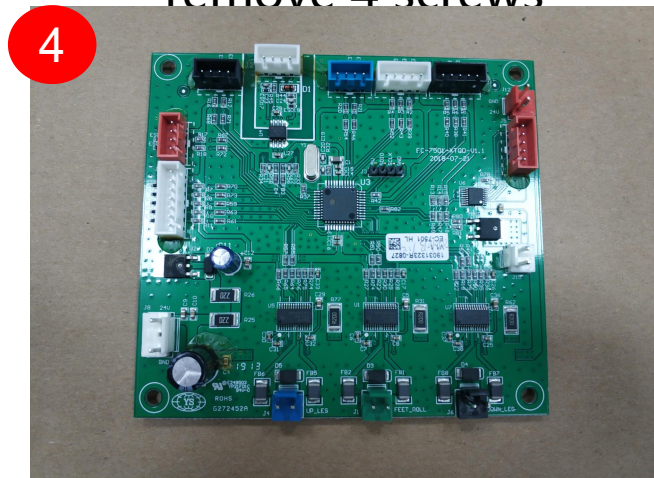

4
remove legrest PCB

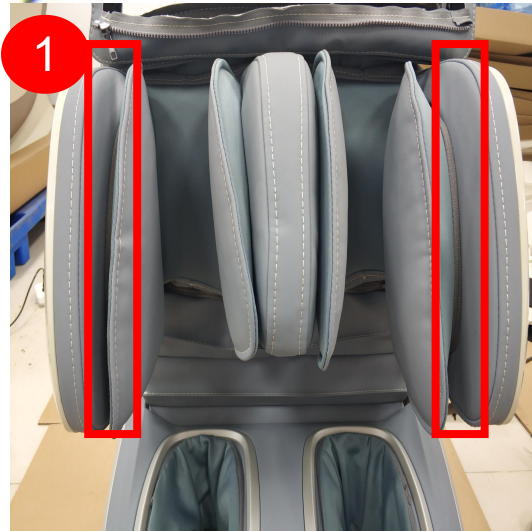

1 unzip the zipper



2 remove 3 screws

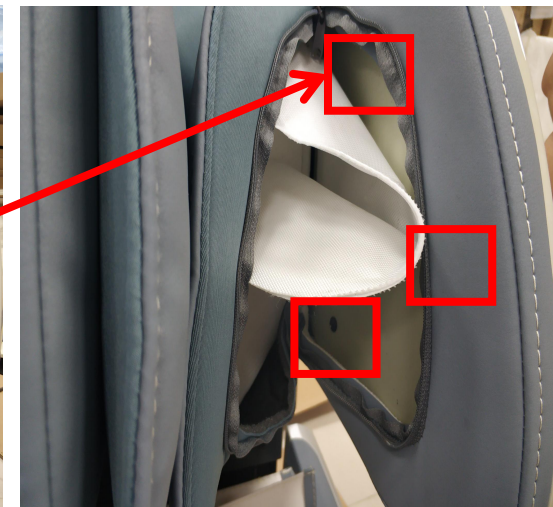

3 disconnected the terminal



5 side cover of upper legrest



6 Anti pinch PCB

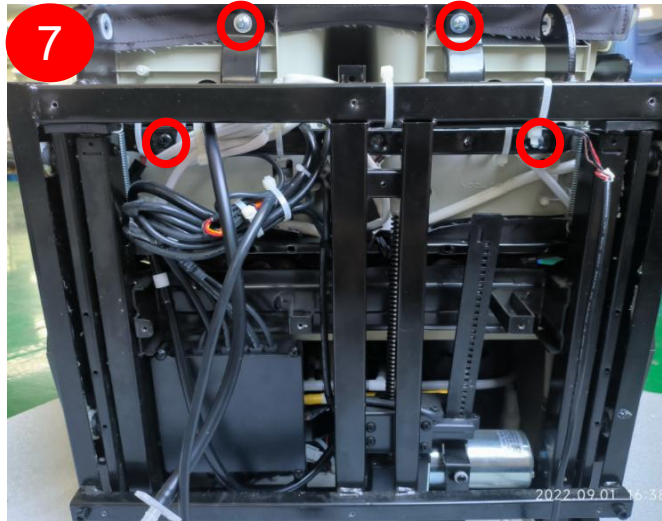

remove the screws



remove the screws

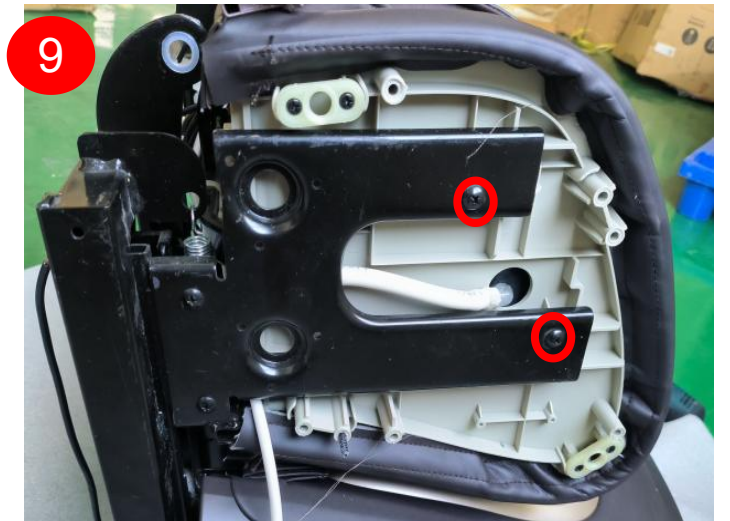

remove the screws



unzip the zipper

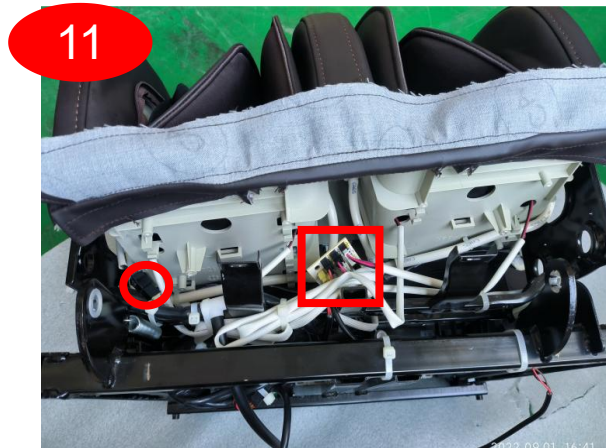

disconnected the terminals and air hose



remove upper legrest



4.6、Disassembly of lower leg assembly

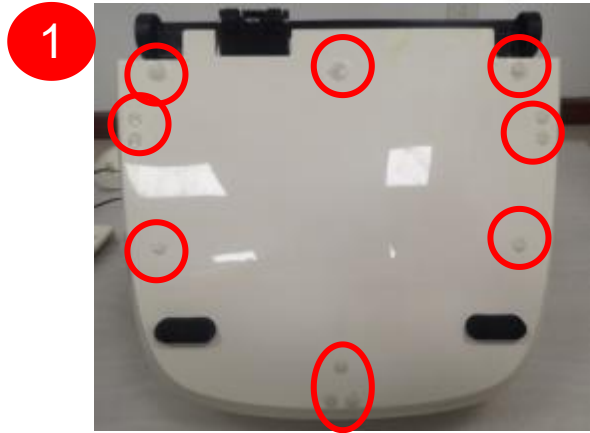

remove the screws fixing the cover

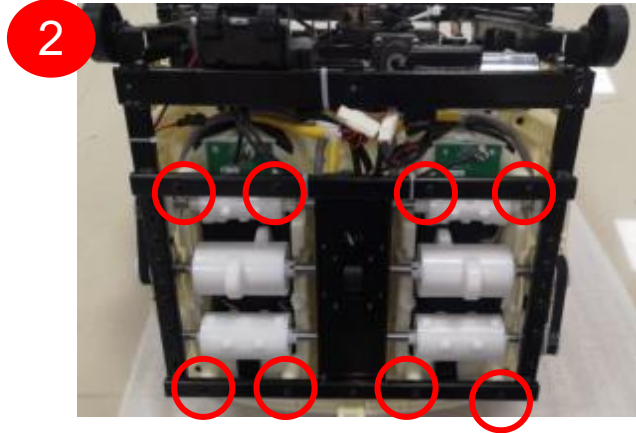

remove the screws fixing lower legrest

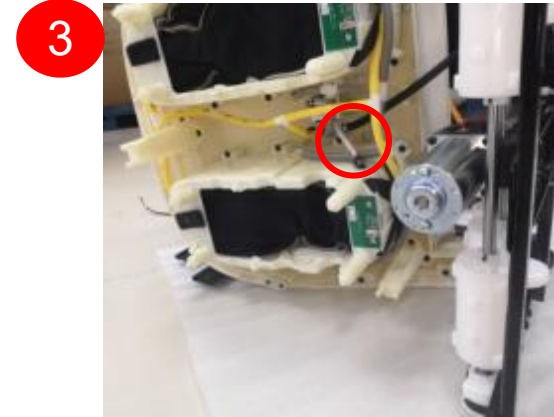

remove lower legrest and we can replace the air bag



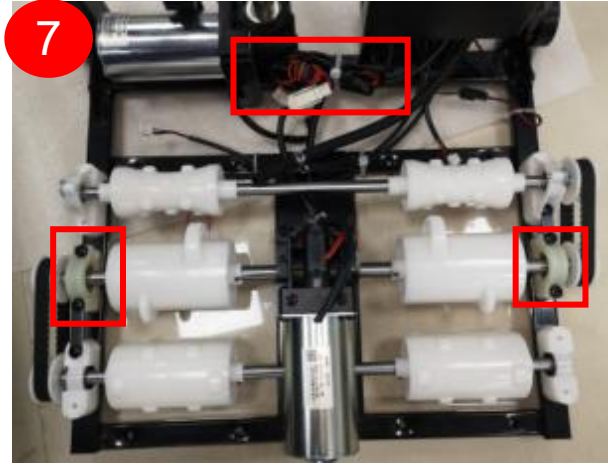

remove the screws fixing the middle roller



remove the middle roller unit



remove front and back roller



4.7、Disassembly of legerst actuator

a. Remove the legerst

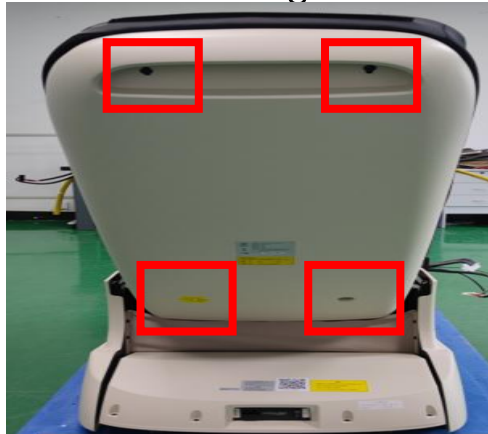

remove 4 screws

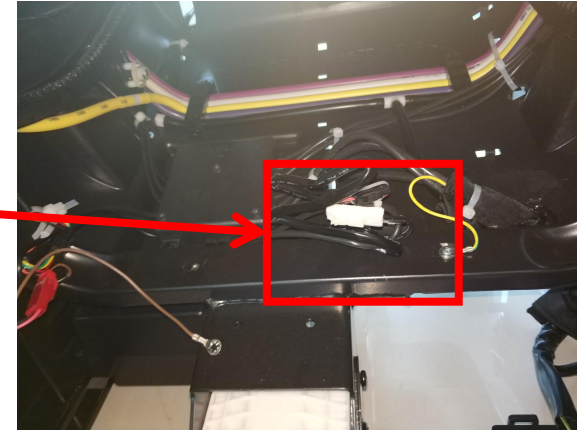
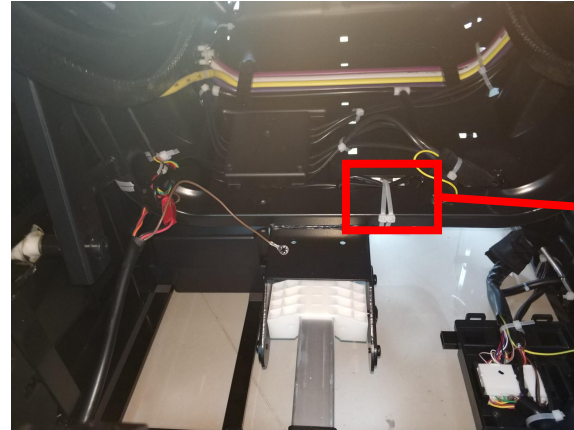

cut cable tie and disconnected the terminals

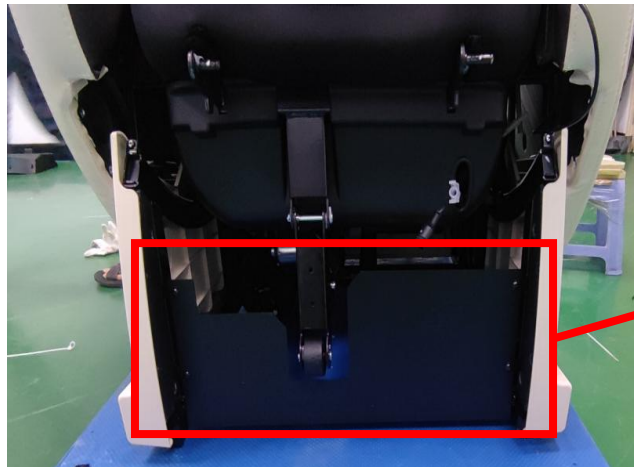

remove 4 screws

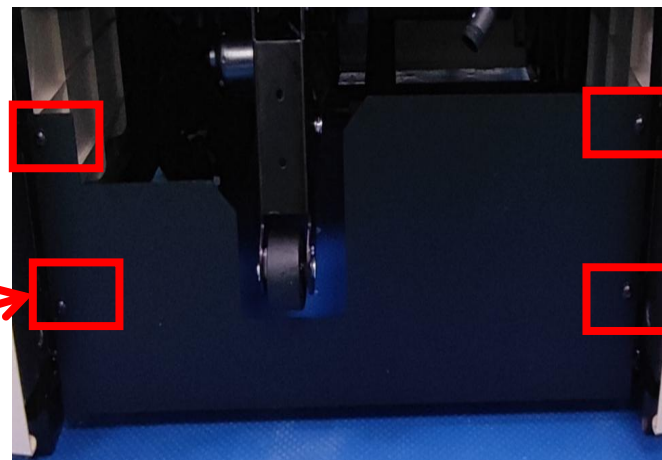

remove front board

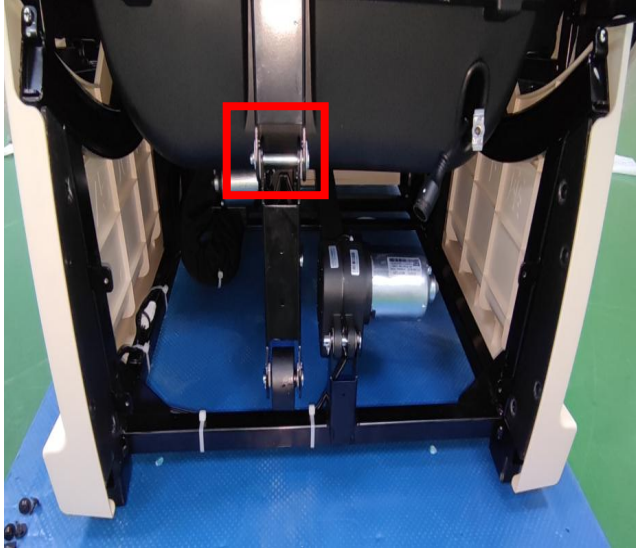

remove the pin and shaft fixing legrest actuator

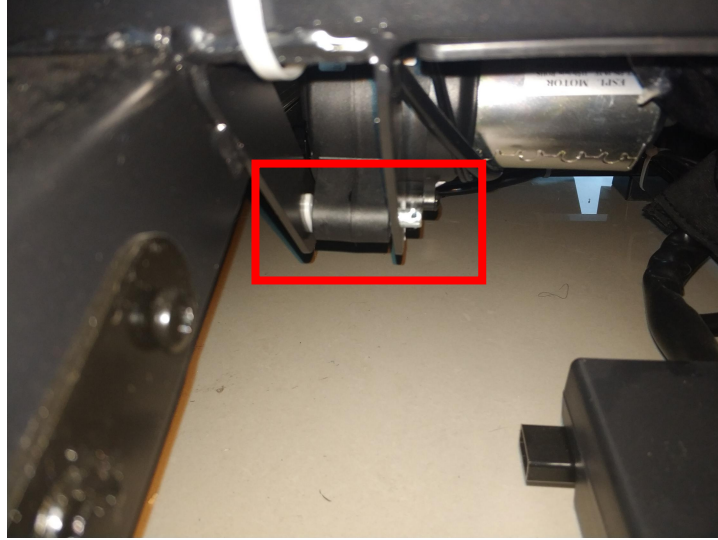

legrest actuator



4.8、Disassembly of backrest actuator

a. remove legrest

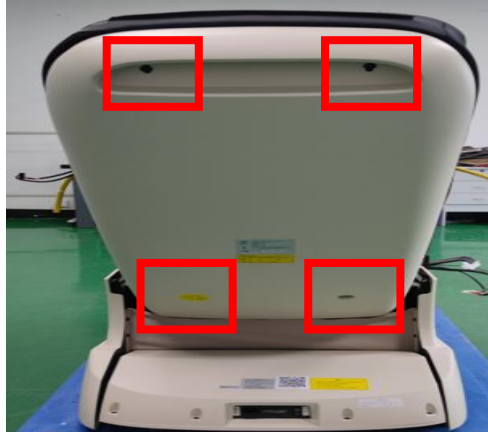

remove 4 screws

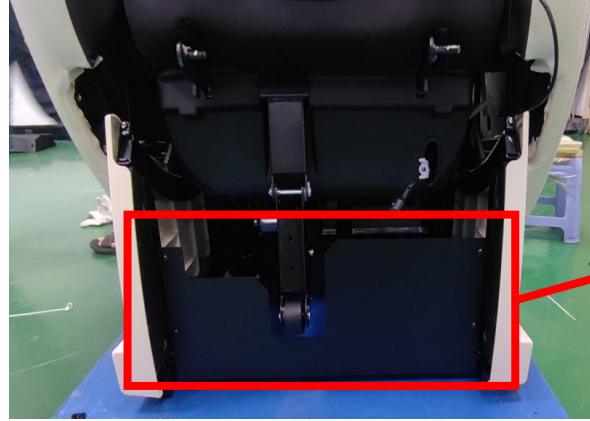

remove 4 screws

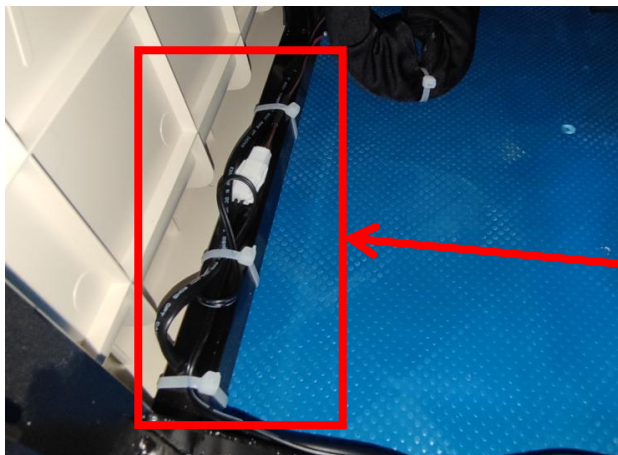
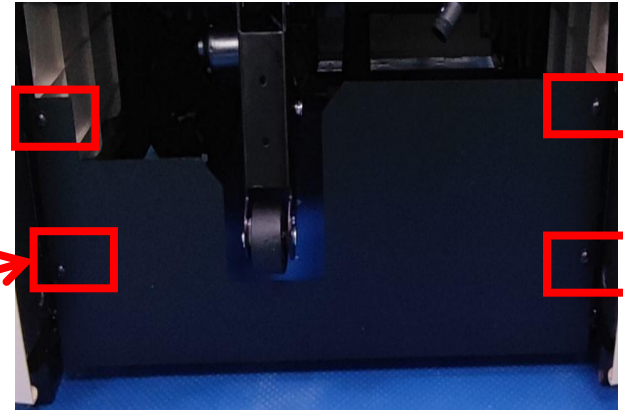

disconnected the terminal of backrest actuator,
remove the pin and shaft

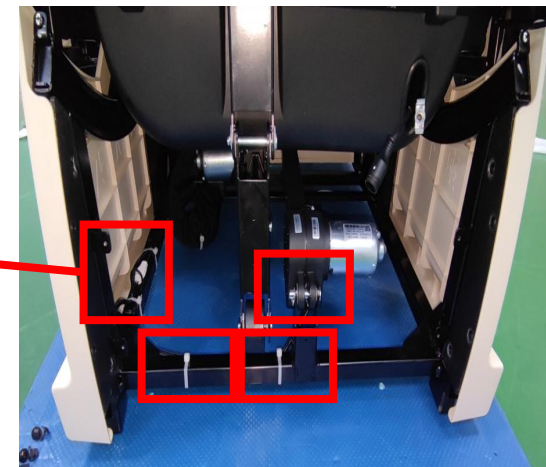

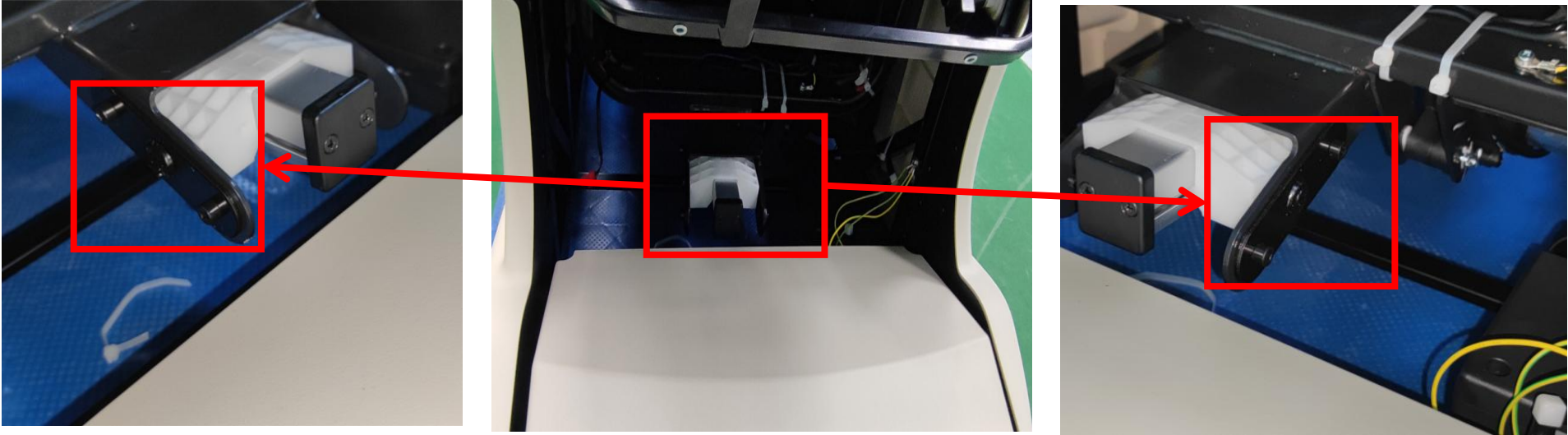

remove the screws



五、Massage chair fault judgment

1、error code:

No.	phenomenon	problem description	steps of shooting the trouble	remark
01	remote control tested any key pressed more than 50 seconds	1.one of the KEY has been blocked.	1.check the key of the remote control	turn on the chair
02	remote control did not connected	1.remote control wire is broken or the remote control is disconnected	1.reconnecte the remote control or change the remote control wire.	turn on the chair
03	backrest signal is abnormity	1.The connector of the backrest wire is not well connected 2.Backrest wire Broken	1.check the connector of backrest wire 2.replace the backrest wire	turn the power
04	rolling signal is abnormity	1.The connector of the backrest wire is not well connected 2.rolling counting sensor broken	1.check the connector of backrest wire 2.rolling counting sensor broken	turn on the chair
05	side panel tested any key pressed more than 40seconds	1.one of the KEY has been blocked.	1.check the key of the side panel	turn on the chair



06		leg rest tested more than 4 seconds	1. connector of leg rest wire not well 2. wire of leg rest broken	1. check the connector of leg rest wire 2. replace the wire of leg rest	turn the power
07		tested more than 2 width inspection signal	1. width inspection board is broken 2. width inspection wire is not well connected	1. change width inspection board 2. change backrest wires	start the rolling function
08		more than 5 seconds did not tested the wide signal	1. width inspection board is broken 2. the wire connect to the width inspection board is disconnected 3. kneading motor is broken or kneading belt is lost	1. change width inspection board 2. change backrest wires. 3. change kneading motor	enter auto-check model
09		more than 5 seconds did not tested the middle signal	1. width inspection board is broken 2. the wire connect to the width inspection board is disconnected 3. kneading motor is broken or kneading belt is lost	1. change width inspection board 2. change backrest wires. 3. change kneading motor	enter auto-check model
10		more than 5 seconds did not tested the narrow signal	1. width inspection board is broken 2. the wire connect to the width inspection board is disconnected 3. kneading motor is broken or kneading belt is lost	1. change width inspection board 2. change backrest wires. 3. change kneading motor	enter auto-check model



11		more than 10 seconds didn't tested kneading signal	1.Main PCB is broken	1.replace main PCB	enter auto-check model
12		when not kneading but the width inspection signal still can be tested	1.Main PCB is broken	1.Change PCB	enter auto-check model
13		tested signals from up & down limit sensor at the same time.	1.up & down limit sensor are broken 2.backrest wire is disconnected.	1.Change up & down limit sensor 2.check whether the backrest wire is well connected	enter auto-check model
14		more than 40s didn't tested the signal from the up limit sensor	1.upper limit sensor is broken. 2.backrest wires is disconnected 3.rolling motor is broken or rolling motor wire disconnected	1.change upper limit sensor 2.check whether the backrest wire is well connected. 3.change rolling motor or rolling motor wire.	enter auto-check model
15		height counting signal error	1.the counting sensor of the rolling motor is broken 2.backrest wire is disconnected	1.change the counting sensor of the rolling motor. 2.check whether the backrest wire is well connected.	enter auto-check model



16		after tested signal from up limit sensor then tested signal from down limit sensor in 2 seconds.	1. down limit sensor is broken	1. change down limit sensor 2. check whether the backrest wire is well connected. 3. change rolling motor	enter auto-check model
17		more than 40s didn't tested the signal from the down limit sensor	1. down limit sensor is broken 2. the backrest wire is disconnected. 3. rolling motor is broken or disconnected	1. change down limit sensor 2. check whether the backrest wire is well connected. 3. change rolling motor	enter auto-check model
18		after tested signal from down limit sensor then tested signal from up limit sensor in 2 seconds.	1. upper limit sensor is broken.	1. change upper limit sensor	enter auto-check model
19		can't test signal from foot rest recline actuator	1. foot rest recline actuator is broken 2. foot rest actuator motor wire is disconnected 3. the signal wire of foot rest actuator is disconnected.	1. change foot rest recline actuator 2. check whether the foot rest recline actuator motor wire is well connected. 3. check whether the signal wire of foot rest actuator is well connected	enter auto-check model



20		test signals from front sensor and rear sensor at the same time.	1. the 6 core signal wire is disconnected. 2. up & down limit sensor of the foot rest are broken	1. check whether the 6 core signal wire is well connected. 2. change up & down limit sensor of the foot rest.	enter auto-check model
21		didn't test signal from front sensor of the footrest more than 20 seconds.	1. the down limit sensor of the foot rest is broken 2. foot rest extending motor is broken or disconnected	1. change down limit sensor of the footrest 2. change the footrest extending motor or check whether the motor wire is well connected.	enter auto-check model
22		After tested front sensor signal, then tested front sensor signal in 2.5 seconds.	1. the upper limit sensor of foot rest is broken	1. change the upper limit sensor of the footrest.	enter auto-check model
23		didn't tested rear sensor signal in 20 seconds	1. the upper limit sensor of foot rest is broken 2. foot rest extending motor is broken or the motor wire is disconnected.	1. change upper limit sensor of the foot rest. 2. change foot rest extending motor	enter auto-check model
24		After tested rear sensor signal, then tested front sensor signal in 2.5 seconds.	1. the lower limit sensor of the foot rest is broken	1. change footrest lower limit sensor	enter auto-check model



25		when start the backrest recline actuator, there is no counting signal for more than 2.5 seconds	<ol style="list-style-type: none"> 1.backrest recline actuator is broken 2.backrest recline actuator wire is disconnected 3.the signal wire of the backrest recline wire is disconnected 	<ol style="list-style-type: none"> 1.change backrest recline actuator 2.check whether backrest recline actuator motor wire is well connected. 3.check whether the signal wire of the backrest recline actuator is well connected 	enter auto-check model
26		when start the zero-gravity actuator, there is no counting signal for more than 2.5 seconds	<ol style="list-style-type: none"> 1.Zero-gravity actuator is broken 2.zero-gravity actuator wire is disconnected. 3.the signal wire of zero-gravity actuator is disconnected 	<ol style="list-style-type: none"> 1.change zero-gravity actuator 2.check whether zero-gravity motor wire is well connected. 3.check whether the signal wire of zero-gravity actuator is well connected 	enter auto-check model
27		The front and rear limit sensors are effective at the same time (3D mechanism)	<ol style="list-style-type: none"> 1. The front and rear limit sensors are broken 2. The terminal of telescopic limit detection line falls off 	<ol style="list-style-type: none"> 1. Replace the telescopic limit sensor 2. Check the connection of telescopic limit detection line 	turn the power
28		The signal of telescopic limit sensor is not detected by 10s telescopic opening clock (3D mechanism)	<ol style="list-style-type: none"> 1. Front limit sensor broken 2. Poor contact of telescopic limit detection line 3. Telescopic motor broken or broken 4. The telescopic limit light baffle is loose 	<ol style="list-style-type: none"> 1. Replace the telescopic limit sensor board 2. Check the connection of telescopic limit detection line 3. Replace the telescopic motor or wiring 4. Check the telescopic limit light shield 	turn the power



29		Abnormal movement telescopic counting signal (3D mechanism)	1. The telescopic counting sensor is broken 2. Poor contact of telescopic counting line	1. Replace the telescopic counting detection board 2. Check the connection of telescopic counting line	turn the power
30		After the signal is detected by the telescopic limit sensor, the signal of the other telescopic limit sensor is detected within 2S (3D mechanism)	1. The telescopic limit sensor is broken	1. Replace the telescopic limit sensor board 1. Replace the telescopic limit sensor board	turn the power
31		side panel control did not connected	1. side panel control wire is broken or the side panel control is disconnected	1. reconnecte the side panel control or change the side panel control wire.	turn on the chair