

Titan

Titan Pro Cura 4D Instruction Manual

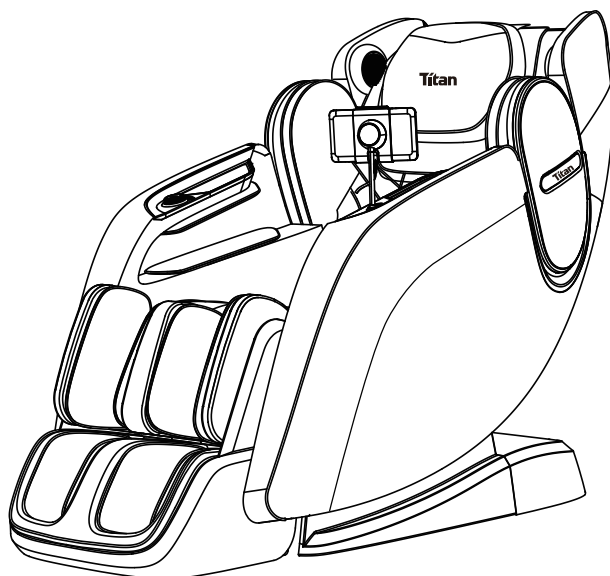

Contents

Thank you for purchasing this massage chair.
Please read all the safety and operational instructions before using the chair.

Cautions and Warnings	2-3
Product Specifications	4
Product Components	5-6
Positioning The Chair	7-8
Moving The Chair	9
Operation Instruction	10-13
Trouble Shooting	14
Product Care and Storage	15-16
Bluetooth link	17
Installation Step	18-21

Thank you so much for purchasing this product. Please read all the safety and operational instructions before using this chair.

Cautions and Warnings

IMPORTANT SAFETY INSTRUCTIONS

When using an electrical appliance, basic precautions should always be followed. Read all instructions before using this massage chair.

1. Always unplug this massage chair from the electrical outlet immediately after using and before cleaning.
2. If liquid is accidentally spilled onto the chair, remove the power plug from the electrical outlet immediately. Do not use wet hands to connect or disconnect the power plug from the electrical outlet.
3. Do not operate during a lightning storm.
4. Although operation will be stopped automatically by the Auto-Timer function, always remember to turn off the main power switch after use.
5. Do not place the power cord under the chair or under any other heavy objects.
6. Do not wind the power cord around the chair as this may damage the cord and result in a fire or electric shock.
7. Do not operate the chair with a damaged cord or with an extension cord.
8. Do not use the chair if the electrical outlet is loose.
9. Check that the Alternating Current (AC) voltage corresponds with the specification indicated for the chair.

WARNING – To reduce the risk of burns, fire, electric shock or injury to persons:

1. This massage chair should never be left unattended when plugged in. Unplug from outlet when not in using, and before putting on or taking off parts.
2. Do not operate under blanket or pillow. Excessive heating can occur and cause fire, electric shock or injury to persons.
3. Close supervision is necessary when this chair is used by, on or near children, invalids or disabled persons. Keep children away from extended foot support.
4. Use this massage chair only for its intended use as described in this manual.
5. Never operate this massage chair if it has a damaged cord or plug, if it is not working properly, if it has been dropped or damaged, or dropped into water.
6. Do not move or carry this massage chair by the power cord or controller, or use the cord as a handle.
7. Keep the cord away from heated surfaces.
8. Never operate the massage chair with the air openings blocked. Keep the air openings free of lint, hair and the like.
9. Never drop or insert any object into any opening.
10. Do not use outdoors.
11. Do not operate where aerosol (spray) products are being used or where oxygen is being administered.
12. To disconnect, turn all controls to the OFF position, then remove the plug from the outlet.
13. Use heated surfaces carefully. May cause serious burns. Do not use over insensitive skin areas or in the presence of poor circulation. The unattended use of heat by children or disabled persons may be dangerous.
14. Never remove the cover from this chair. Do not use the chair when the upholstery is ripped, torn, or removed. This may cause injury or malfunction. Carefully examine the covering before each use. Call for service if the covering shows any sign of deterioration, such as blistering, peeling, cracking, or ripping.

Cautions and Warnings

15. Keep dry - do not wet. Do not operate in a wet or moist condition. Do not use the chair when your body is wet. Do not operate this chair with wet hands.
16. Connect this chair to a properly grounded outlet only.
17. Do not insert your hand or foot along the paths of the massage rollers during use as this may cause injury.
18. This massage chair is not intended for use by children or persons with reduced physical, sensory or mental capabilities, or lack of experience and knowledge, unless they have been given supervision or instruction concerning use of this chair by a person responsible for their safety.
19. Children should be supervised to ensure that they do not play with this massage chair.
20. Any individual who may be pregnant, or recently gave birth, has a heart condition, or a pacemaker, suffers from diabetes or other sensory impairment, phlebitis and/or thrombosis, joint dysfunction, inflammation or injuries, weak bones, osteoporosis, a high fever, an abnormal or curved spine, is at an increased risk of developing blood clots, has pins/screws/artificial joints or other medical devices implanted in his/her body, is being treated for a medical condition or physical injury or is under a doctor's care should consult with a medical professional before using this massage chair.
21. This massage chair is not intended for self-treatment of conditions that should be managed by a qualified healthcare provider.
22. Consult your physician before using this massage chair.
23. This massage chair is designed as a non-professional massager to help soothe tired and aching muscles. It is not intended to be a substitute for medical attention. If your ailments and symptoms persist or worsen after use, contact your physician immediately.
24. Do not use this chair if you are not feeling well.
25. Stop operation immediately if you experience any discomfort.
26. Do not fall asleep during the massage session.
27. Do not operate after taking pain killers, sedatives or alcohol.
28. Do not use this chair in combination with other therapeutic equipment or electric blanket, etc., as this may result in ineffectiveness or injury.
29. Do not stand on or in this massage chair. Use only while seated.
30. Do not disassemble any part of the chair. Touching the internal components may result in malfunction or electric shock.
31. The chair must only be professionally serviced or repaired. Do not attempt to disassemble or repair the chair yourself.
32. Always position the massage chair on a flat, level surface.
33. Do not operate for more than 30 continuous minutes. Turn off the chair and allow it to rest (cool) for 30 minutes before re-using. This will prolong the life of the chair.
34. Do not perform continuous massage on the same spot of your body for more than 5 minutes at a time as this may result in excessive stimulation and may have adverse effects.
35. Never use the chair on open skin eruptions, swollen or inflamed areas.
36. Do not apply massage rollers directly on the head, elbow or knee joints, torso or abdomen.
37. If the power goes off during use, be sure to turn the power switch to the OFF position and pull the power plug out from the socket to prevent damage from occurring when the power is restored.
38. Do not use massager in close proximity to loose clothing or jewelry.
39. Keep long hair away from massage chair while in use.

Product Specifications

Product name: Massage Chair

Model No.: Titan Pro Cura 4D

Rated frequency: 60Hz

Rated voltage: 110V~

Rated power: 180W

Safety design: Class I

Net weight : 189.6 lbs

Gross weight: 242.5 lbs

Product size: 64.6" * 31.1" * 46.1"

Fusible Specification

5A/110V/250V

CAUTION: To prevent electric shock, unplug before replace the fuse and other service.

WARNING

1. The maximum rated user weight (load) is 275 Lbs.
2. To reduce the risk of personal injury, read and understand all the instructions before using this product.
3. BURNS may RESULT FROM IMPROPER USE. HOUSEHOLD AND INDOOR USE ONLY. READ INSTRUCTIONS BEFORE USING.
4. DO NOT WET. DO NOT USE PINS. USE PERSONAL DOMESTIC ONLY. NEVER REMOVE COVER.

WARNING

1. Under no circumstances should the user disassemble the back cushion.
2. Do not use it in a humid environment.
3. Before inserting the power plug, ensure that the power switch is off and the power plug is fully inserted into the socket.
4. Non-professionals are forbidden to open or repair the product.
5. The equipment must be repaired or cleaned with the power circuit disconnected.
6. Burns may result from improper use, read instructions before using. Do not wet. Do not use pins. Never remove cover.

Product Components

Main Body Diagram (front)

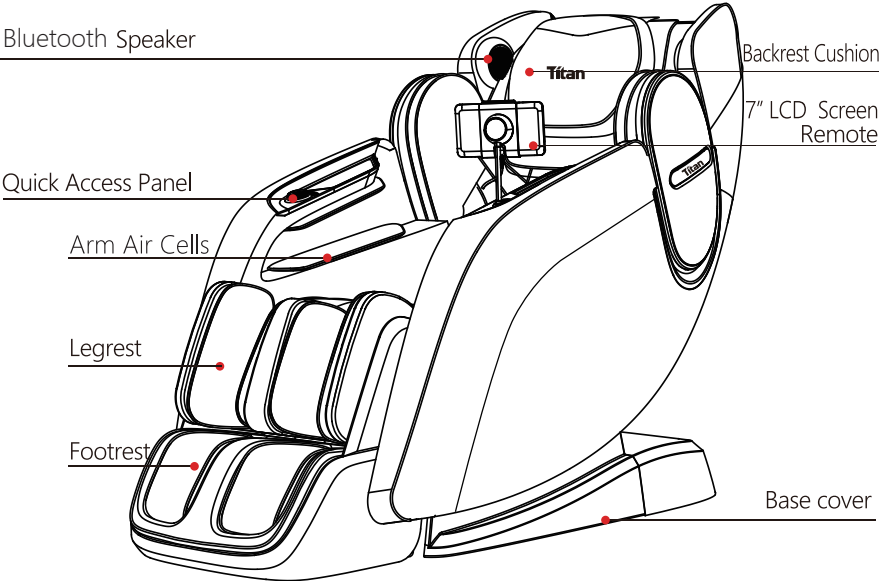

Product Components

Main Body Diagram (Back)

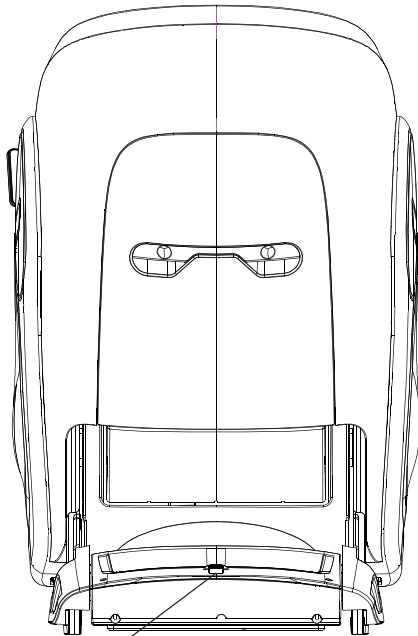

Power switch

Positioning The Chair

When positioning your Massage Chair, allow sufficient space between the chair and walls or other obstacles, and place in an appropriate location.

- Allow 5.9" between the back of the chair and any walls or obstacles.
- Allow 11.8" between the footrest and any walls or obstacles.
- Place on a dry, level surface.
- Do not place in direct sunlight or in places of high temperature.
- Keep a distance of more than 1m from audio-visual equipment such as TVs and radios to prevent signal interference.

Warning: Do not put the power cord under the chair.

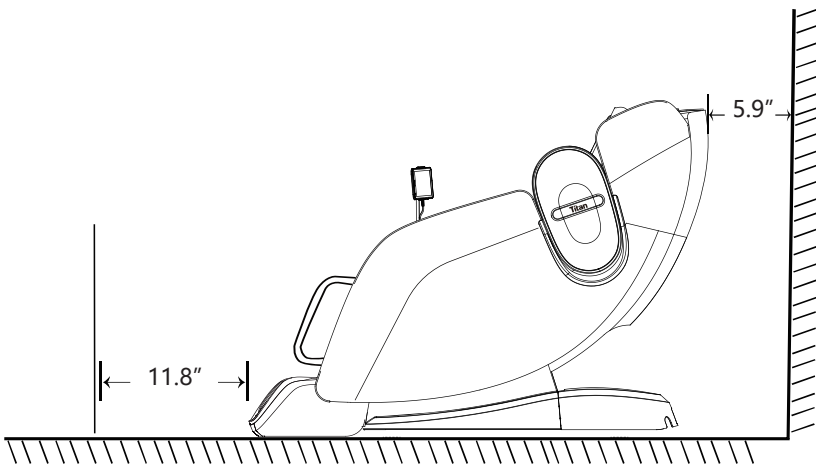

Positioning The Chair

Machine adjustment

*Use the controller to place the backrest frame to the extreme position, raise the calfrest to the highest and longest position.
Make sure there is sufficient space around the massage chair before operation.



Before sitting

*Do not sit while the calf massage stand is raised
*Avoid applying sudden or excessive pressure to the calf frame, as this may damage the mechanical structure.

Moving The Chair

1. To move the massage chair, lift up by the head part until the chair inclines on its casters at about a 45° angle.
2. Slowly push and maneuver the massage chair to the desired location. Lower the chair slowly and smoothly until it is fully flat on the ground.
 - Do not move the massage chair when someone is sitting in it. This will cause the chair to tip over, resulting in accident and injuries.
 - Moving the massage chair may cause damage to floors. Floor protection, such as rugs or carpet, is recommended.
 - Do not drop or suddenly let go of the chair when moving, as it may damage the chair.

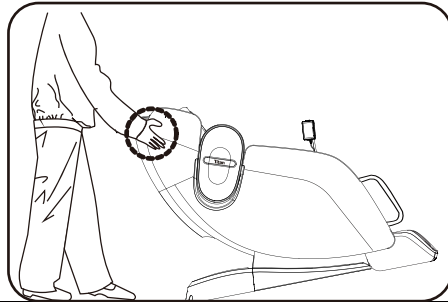

-
- To avoid injury and minimize the chance of dropping the chair, it is recommended that two people move the chair.
 - Do not move by pulling on the cord or on the controller.

Operation Instruction

Connect the power supply

1 Plug into wall socket

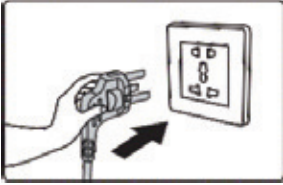

2 Plug into the chair power port

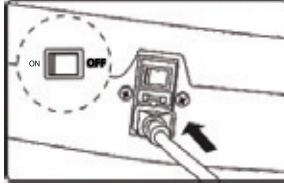

3 Switch "ON" to use

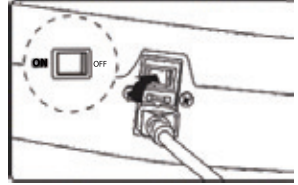

1. Turn on LCD SCREEN to start massaging.

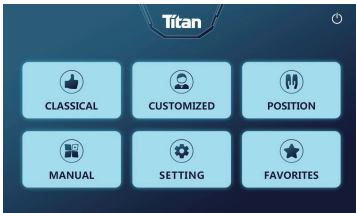

2. There are six options on the home page: CLASSICAL, CUSTOMIZED, POSITION, MANUAL, SETTING, FAVORITES



3. After selecting the CLASSIC mode, there are 8 programs: DEMO (Massage 5 mins only), THAI STRETCH, BODY CIRCULATION, RELAX, MORNING CARE, MIDDAY CARE, NIGHT CARE, DEEP TISSUE

Operation Instruction



4. After selecting the CUSTOMIZED mode there are 8 programs: EXTENSION, WOMEN'S HEALTH, SHIATSU, MEN'S HEALTH, OFFICE RELIEF, SPORTS RECOVERY, FOOT CARE, REJUVENATE



5. After selecting the POSITION mode, there are 8 programs: NECK MASSAGE, NECK AND SHOULDER MASSAGE, BACK MASSAGE, LUMBAR MASSAGE, WAIST & HIP MASSAGE, LEGS MASSAGE, UPPER BODY, LOWER BODY

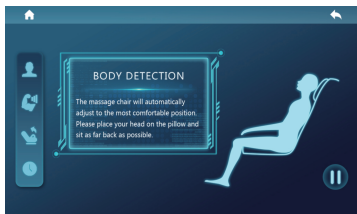

6. After selecting the automatic massage program, the chair will start conducting a body scan. To enjoy the most comfortable massage, please place your head on the pillow and sit as far back as possible.

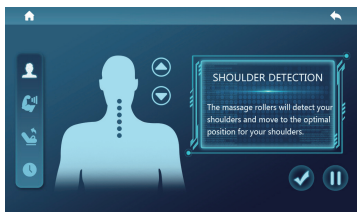

7. After the body scan, the shoulder detection will begin where the massage rollers will move from the top to the optimal shoulder positions.

Operation Instruction



8. After selecting the CUSTOM mode, it will enter the CUSTOM mode page: In this page, you can select the body parts of the air cells massage, such as the FULL BODY, SHOULDER, HAND, WAIST & HIP, LEG & FOOT massage, or you can select the massage action: like KNEADING, PERCUSSION, ACUPRESSURE, FLAP, SLAP, MIXTURE



9. In MANUAL mode massage position page, you can control the massage hand position through FIXED POINT, FULL BODY, AREA, UP and DOWN.

In "full body" mode, "up" and "down" are invalid



10. In MANUAL mode OPTIONS page, you can choose the other functions you may need, such as: HEATING, LEG ROLLING, FOOT ROLLING, RANGE, WIDE, MEDIUM and NARROW.

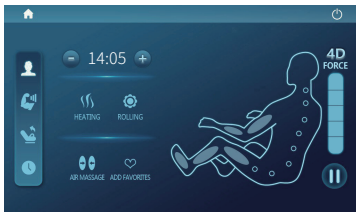

11. There are 7 functions: HEATING, ROLLING, AIR MASSAGE, 4D FORCE and ADD TO FAVORITES.

You can add your favorite massage program into ADD TO FAVORITES.

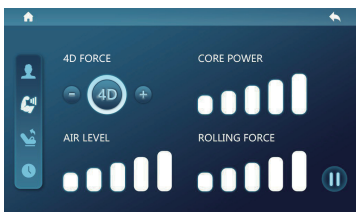

12. This button helps to control: 4D FORCE, CORE POWER

AIR LEVEL and ROLLING FORCE

Note: some actions are controlled by automatic program, and manual adjustment is invalid at this time.

Operation Instruction

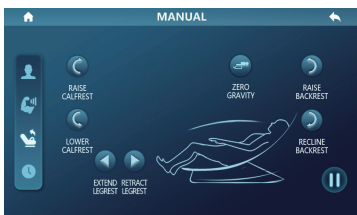

13. This button to help to control: RAISE CALFREST, LOWER CALFREST, ZERO GRAVITY, RAISE BACKREST, RECLINE BACKREST, EXTEND LEGREST, RETRACT LEGREST

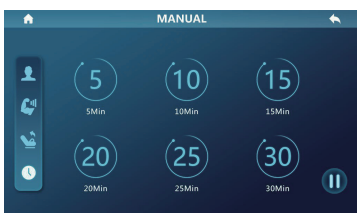

14. This button to change massage time: 5Min, 10Min, 15Min, 20Min, 25Min, 30Min

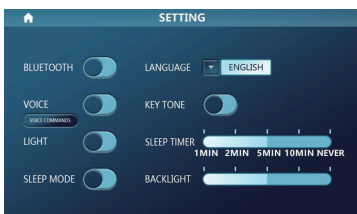

15. Home page SETTING you can control The BLUETOOTH, VOICE, LANGUAGE, KEY TONE, SLEEP TIMER, LIGHT, SLEEP MODE, BACKLIGHT

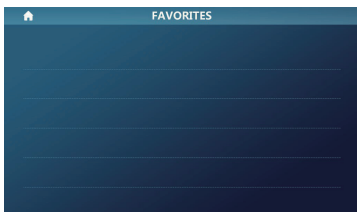

16. FAVORITES: You can add favorite programs to this page and delete them whenever you'd like.



17. Go to " SETTING" and tap the "VOICE CONTROL" icon to activate it. Then say " Hi, Titan/Hey, Titan ", you will get a reply "What can I do for you?"

Trouble Shooting

If you encounter problems while operating the massage Chair, try the suggestions below.

If the massage chair still is not operating properly, click the main power switch on the back of the chair to the OFF position and remove the power plug from the electrical outlet.

Do not dismantle or attempt to repair the Massage Chair yourself. Doing so will void the warranty and will not bear any responsibility for any subsequent consequences.

Problem Possible cause/action

Problem	Possible cause/action
<ul style="list-style-type: none">• The massage chair is connected to the power source but it is not functioning	<ul style="list-style-type: none">• Check that the main power switch on the back of the chair is in the ON position.• Check that the power plug is inserted properly and the power outlet is functioning properly.• Press the Power button on the controller.• Check the fuse next to the main switch in the back of the chair.
<ul style="list-style-type: none">• The controller is responding, but the massage chair is not functioning	<ul style="list-style-type: none">• The massage chair may have automatically shut down due to overheating protection devices. Please turn off the power and allow the chair to cool for 30 to 50 minutes.• Check that the main power switch on the back of the chair is in the ON position.
My massage has stopped	<ul style="list-style-type: none">• Automatic and manual programs last for 15 minutes (6 minutes for the Quick program). When the program completes, the chair turns off.• The massage chair may have automatically shut down due to overheating protection devices. Please turn off the power and allow the chair to cool for 30 to 50 minutes.
<ul style="list-style-type: none">• There is noise during the massage.	<ul style="list-style-type: none">• Some sound is generated by the massage mechanism. This is unavoidable.

Product Care and Storage

*After using the massage chair, please turn off the power switch and unplug the power plug from the power socket

*To avoid accidents caused by children accidentally starting the massage chair, turn off the power switch when not using the massage chair, and then pull the power plug out of the power socket

*If you do not use it for a long time, please store the massage chair.



- Disconnect the massage chair from the power source after use.
- Keep the massage chair away from direct sunlight, high temperature, or high humidity.



- Do not put heavy objects on the massage chair.
- Do not store the massage chair under direct sunlight or in places of high temperature. This may cause the upholstery to fade.

Cleaning the Massage Chair

Never use scouring pads, abrasive cleaning agents or aggressive liquids such as petroleum or acetone to clean the chair.



Do not immerse the chair in water.

Product Care and Storage

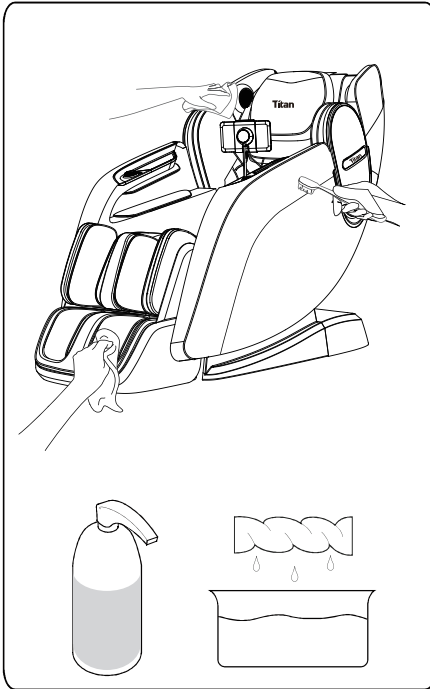

.Remove the main plug from the electrical socket.

.Clean the controller and cords with a dry cloth.

Do not use a moist cloth or a cleaning agent on the controller or cords. You may clean the chair with a cloth dampened with water, but do not use anysol vents or abrasive cleaning agents.

.If a damp cloth is used, allow the chair to air dry.

Do not use an electrical dryer.

Be sure that the chair is completely dry before plugging the power back into the electrical outlet.

Caution

Do not use abrasive cleaning agents like benzene,alcohol or thinner to clean the massage chair

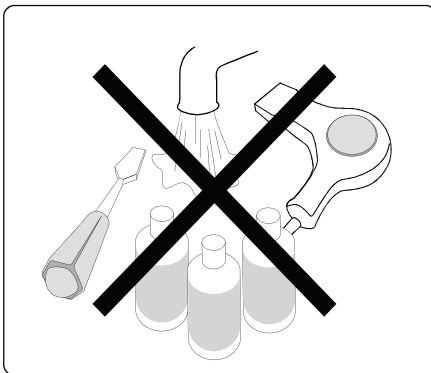

.Do not pour any liquids directly onto the chair.

.Any additional servicing should be performed by an authorized service representative.

This chair has no user serviceable parts inside.

Bluetooth link

After the product is powered on, Bluetooth will be activated automatically. Open the phone and select the Bluetooth name to pair the device.

Pair the device, then open the music software to play music. Note that due to differences in phone models, the Bluetooth name might be garbled or not easily found.

The Bluetooth name may appear garbled or may not be searchable.

If you encounter issues, please contact pre-sales customer service for assistance.

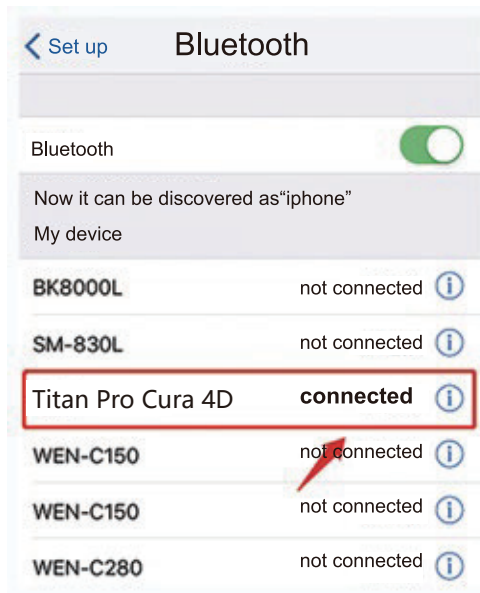

Remove the package and take out the chair parts

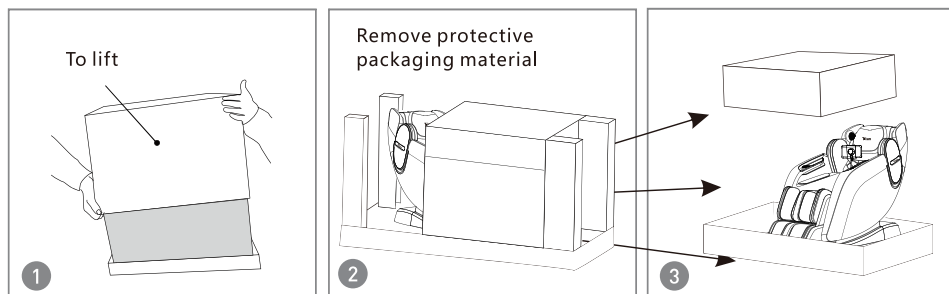





1 Take out the carton

2 Take out packing materials

3 Remove all parts, including the parts list below

1. A screwdriver and Allen key are required to complete the installation. The Allen key and screwdriver are in the parts bag.

Massage chair spare parts list

Name	Quantity	Picture	Name	Quantity	Picture
Power cord	1		Cross point screwdriver	1	
M6 Allen key	1		Manual	1	
M8 Allen key	1				
Remote	1				

Installation step

Installation step

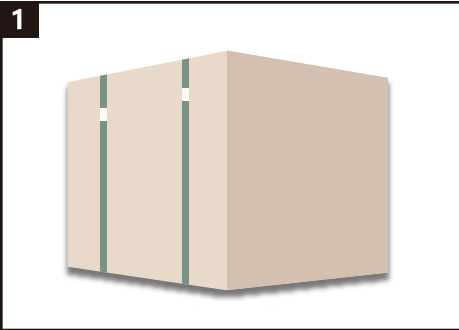

Our chair is shipped in one box

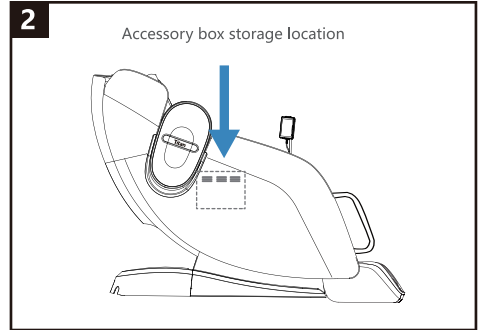

Take out the accessory box

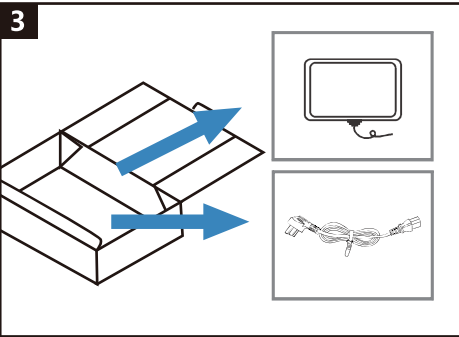

Open the box to take out the Remote control Pad

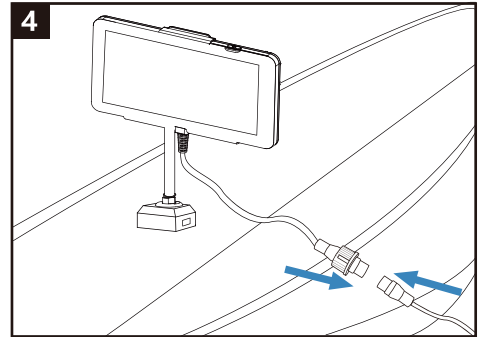

Connect the remote controller

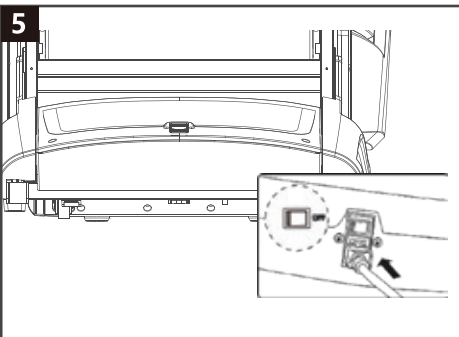

Power on Chair

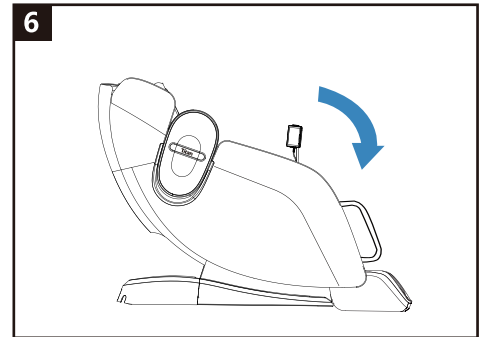

Press remote "on" button to reset the position of massage chair