

A502S-2 Massage Chair After-sale Maintenance Working Principle of Massage Chair

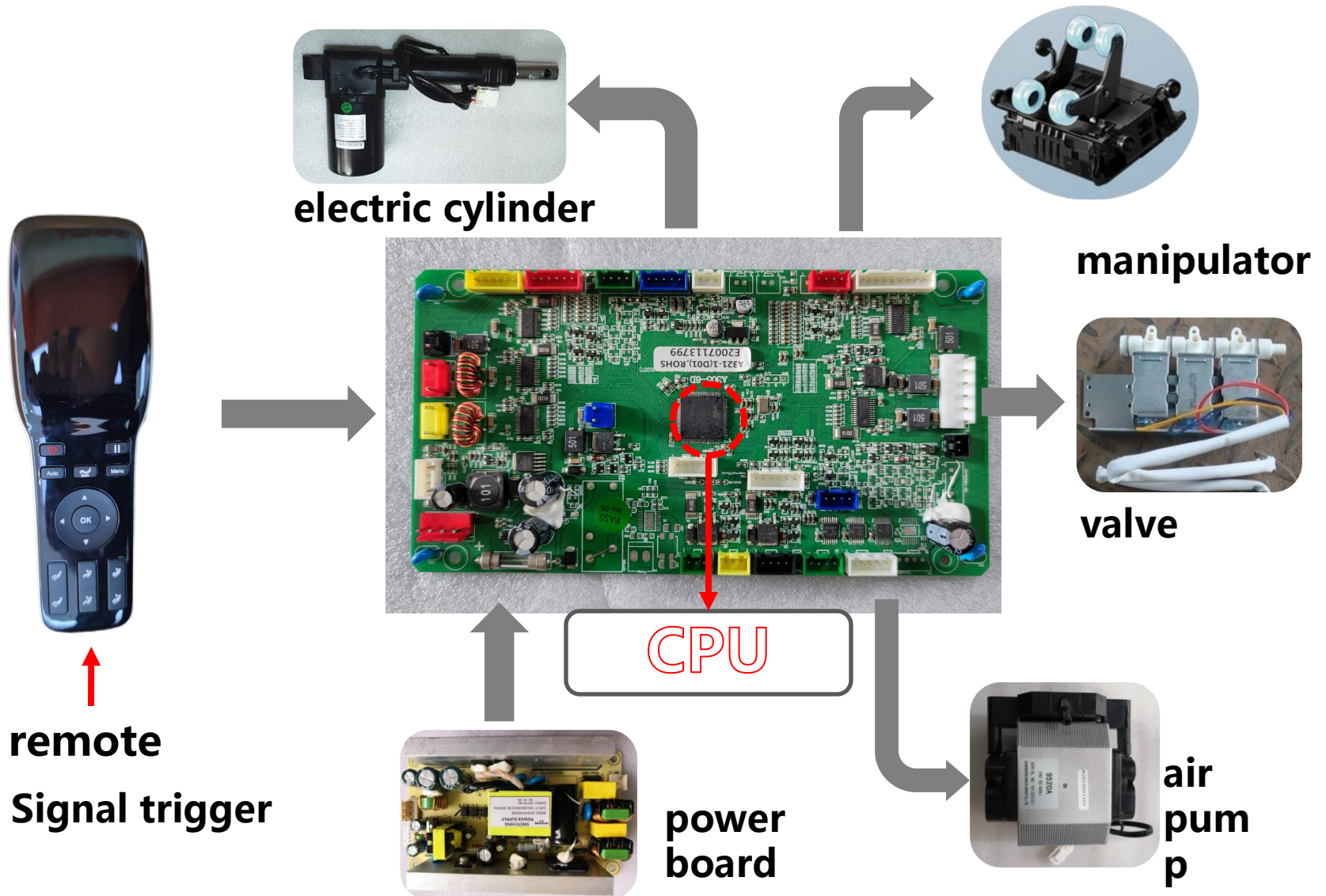

massage chair work principle

Acro



Acro massage chair after-sale service product internal structure

- 1. Part name**
- 2. Schematic diagram of internal structure**
- 3. Distribution diagram of drive board plug-ins**



Introduction of product structure

Acro

Part Name

1. Head cushion
2. Sound
3. Upper arm airbag
4. Palm Arm Bag
5. Help shortcut keys
6. Bump Magnetic Therapy Massage
7. Health test seat
8. Controller placement slot and USB Charge Plug
9. Remote controller
10. Seat cushion
11. Leg rest
12. Foot
13. Backrest cushion
14. LED Artistic Conception Lamp
15. Help
16. Side cover

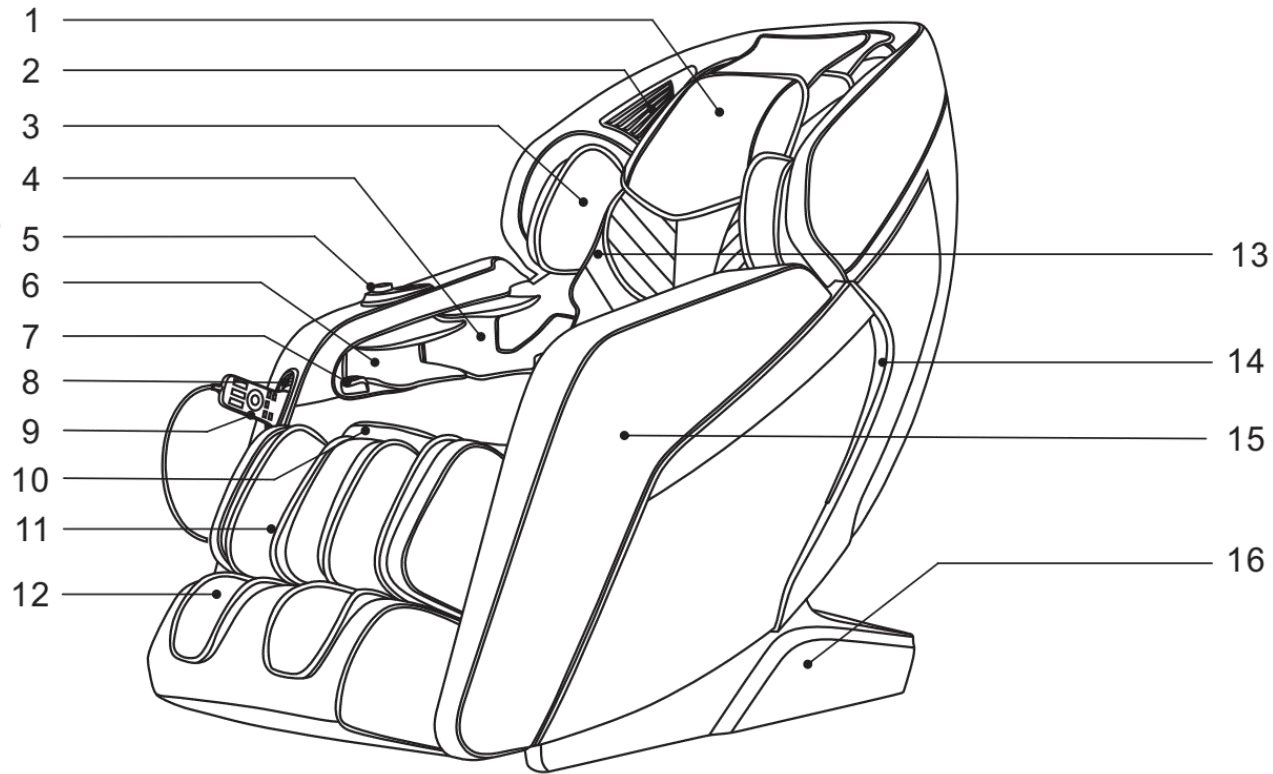

Part Name

17. Backrest cover

18. Back cover of power box

19. Caster

20. Power cord and plug

21. Fuse

22. Switch

23. Power Transmission

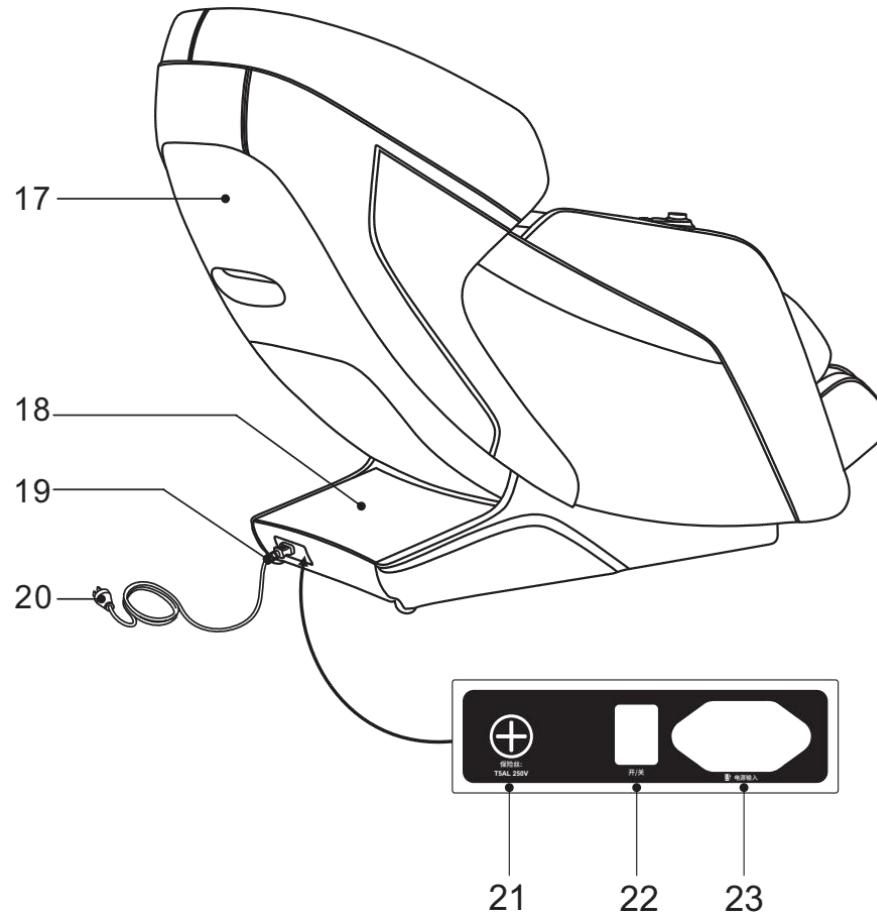

4.3 Schematic diagram of internal structure

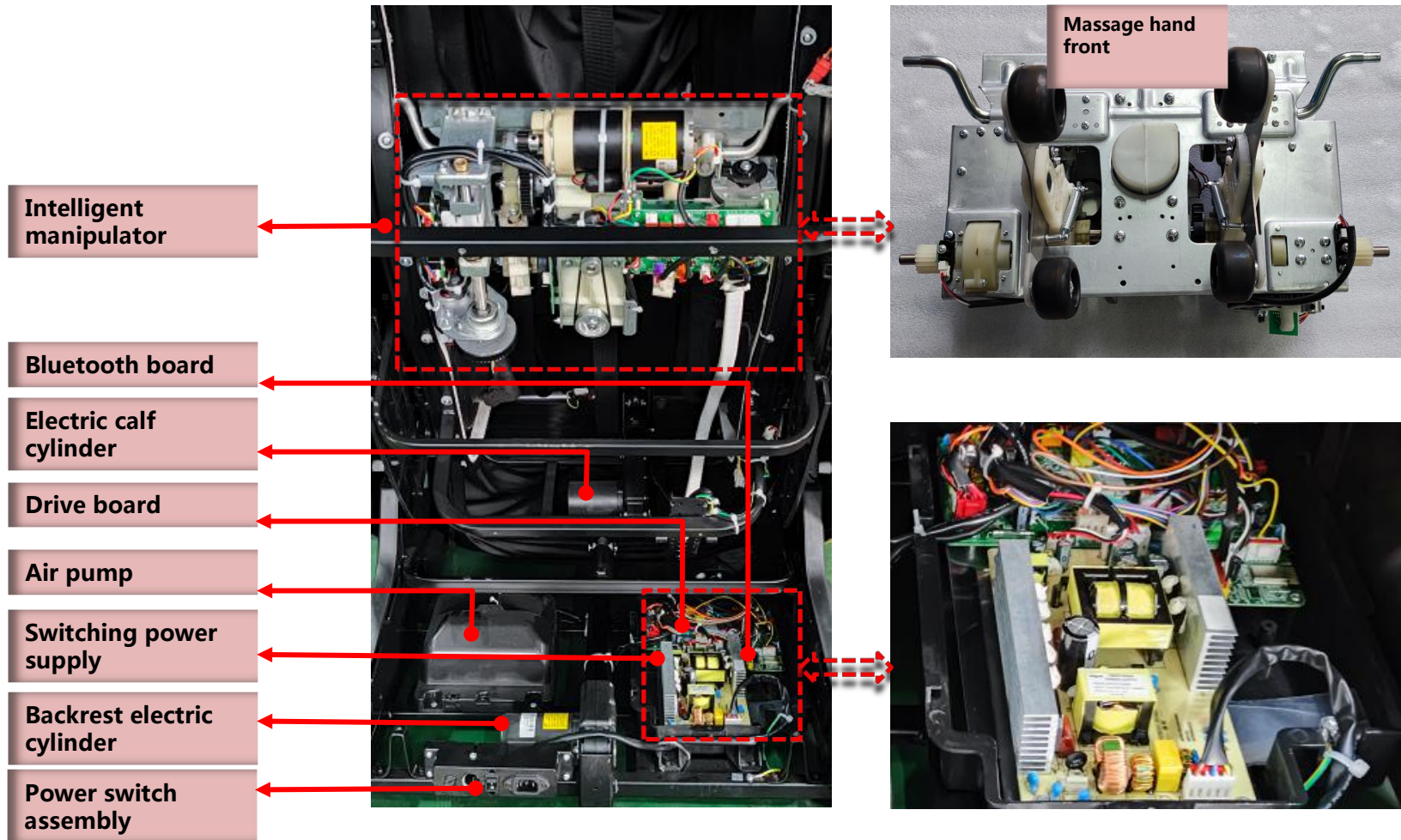

4.4 Schematic diagram of internal structure

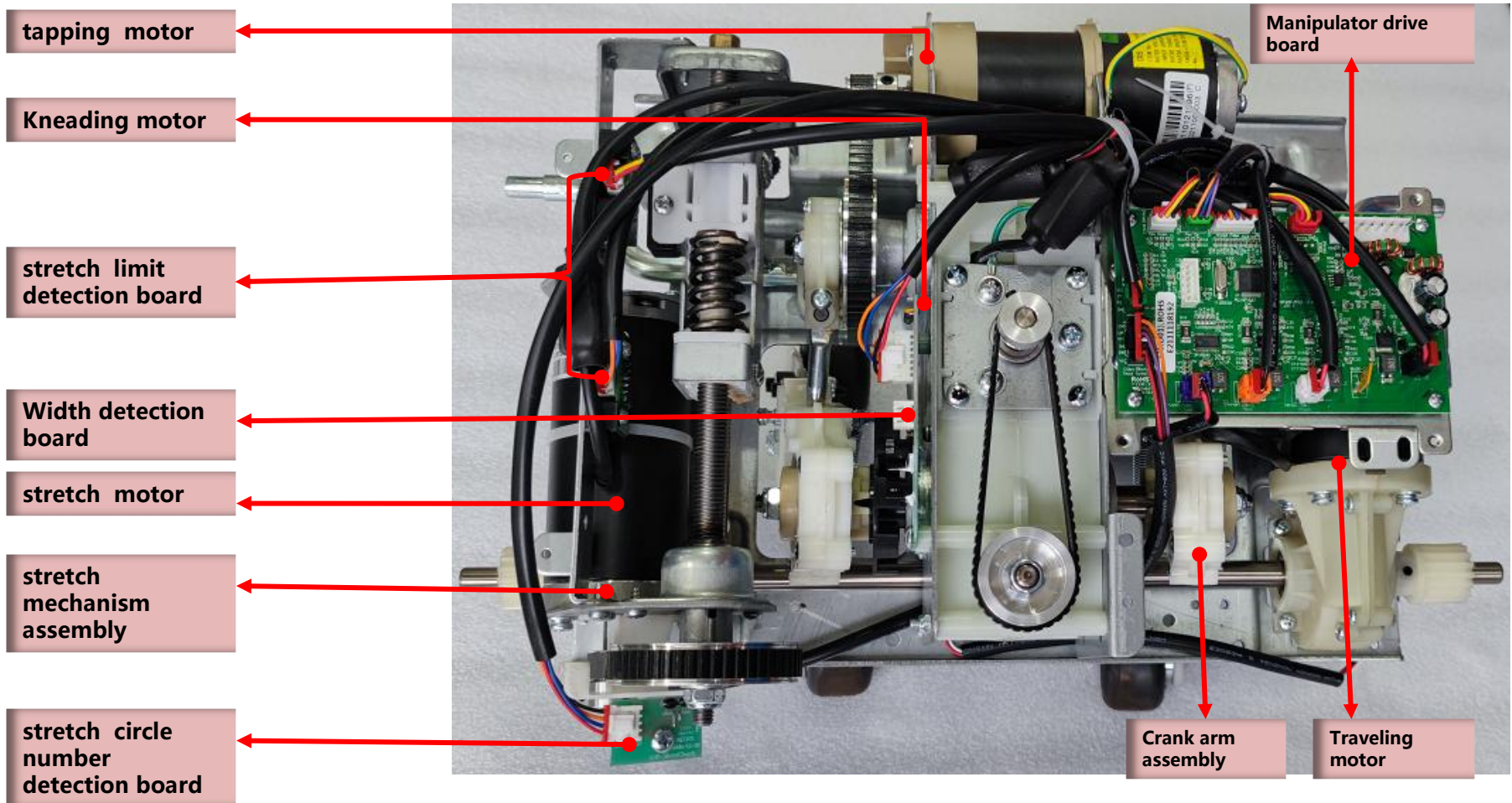

Introduction of product structure Acro

4.5. Schematic diagram of distribution of manipulator drive board

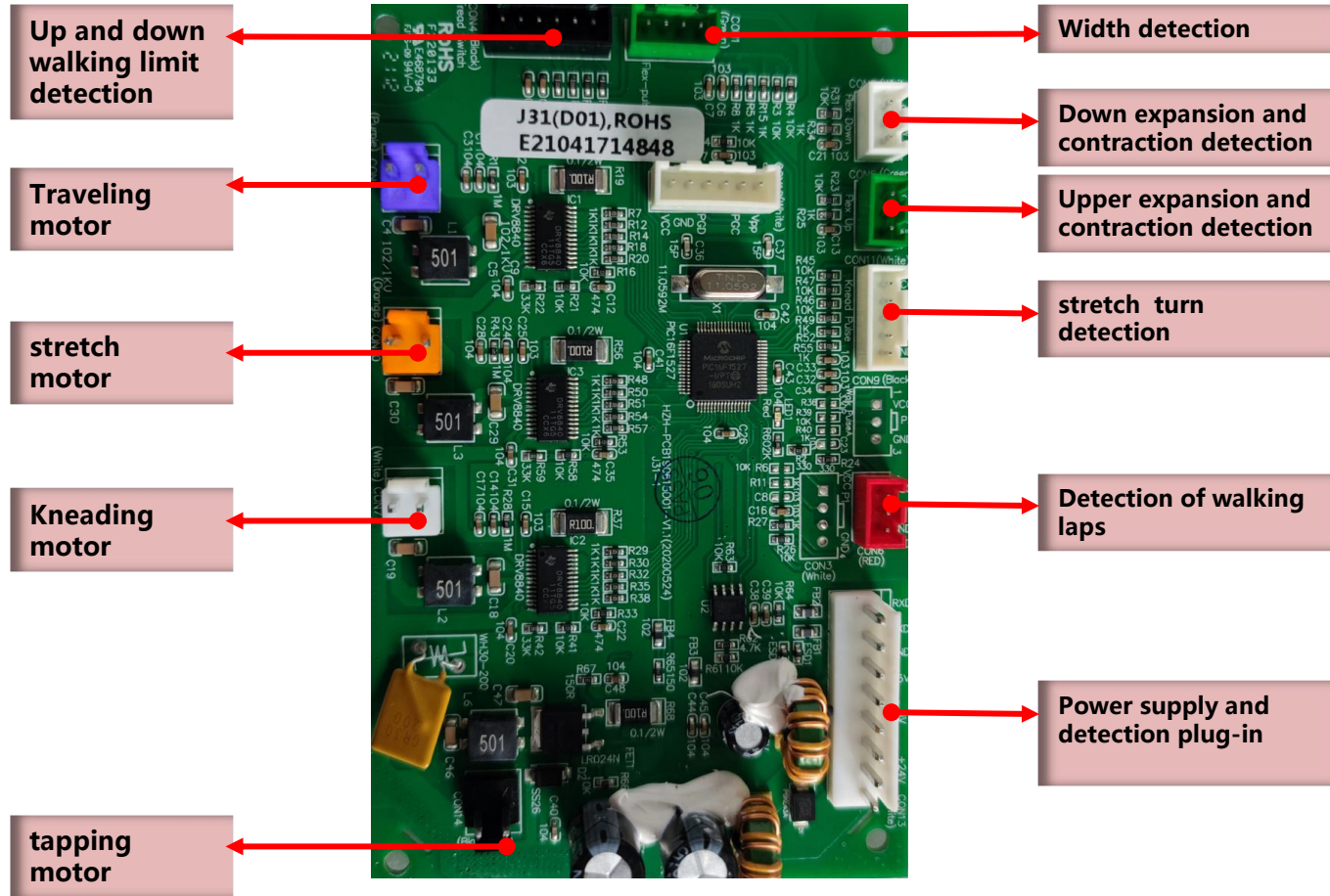

Introduction of product structure Acro

4.6、 Driver board plug-in distribution diagram

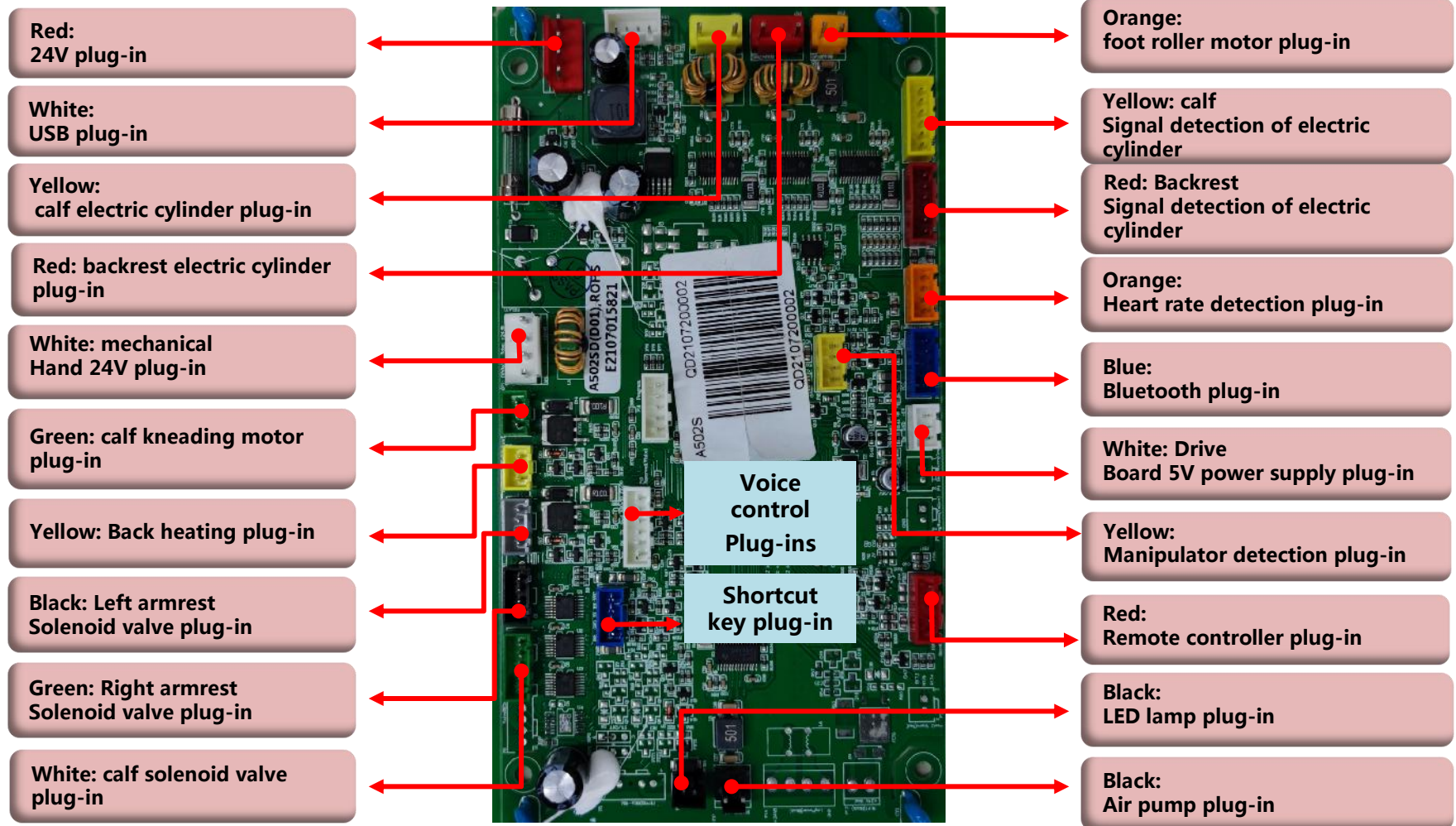

4.7. Schematic diagram of power board plug-in distribution

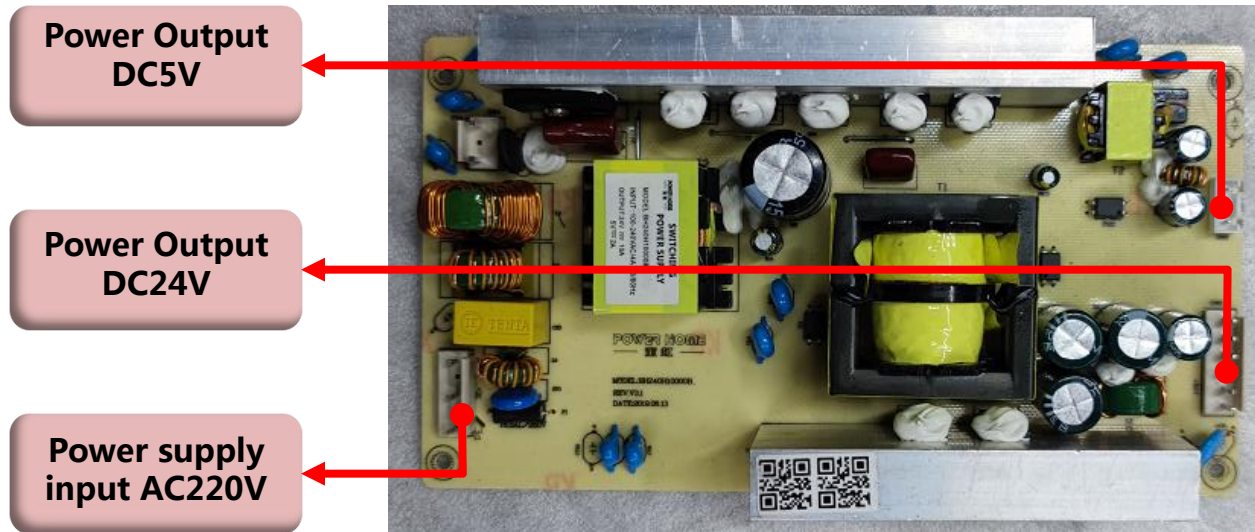

5.1. Disassembly Schematic Diagram of Cushion Assembly

1. Remove the chain at the position of 7 red lines on the inner side of the cushion edge

2. Lift the cushion and remove the heating wire interface on the right to remove the cushion assembly



A



B

5.2. Schematic diagram of calf disassembly



A



B



C

A. Remove the mounting seat screws 1 ~ 2 in Figure A

B. Separate the air hose from the plug-in 3 in Figure B

C. Remove the lower leg assembly

Product disassembly and assembly (backrest cover and drive box cover) Acro

5.3. Schematic diagram for disassembly of backrest cover and drive box cover



A

A. Remove the screws 1 ~ 4 in Figure A to remove the rear cover



B

**B. remove the screws 5 / 6 in Figure B
Remove the back cover of the seat frame**

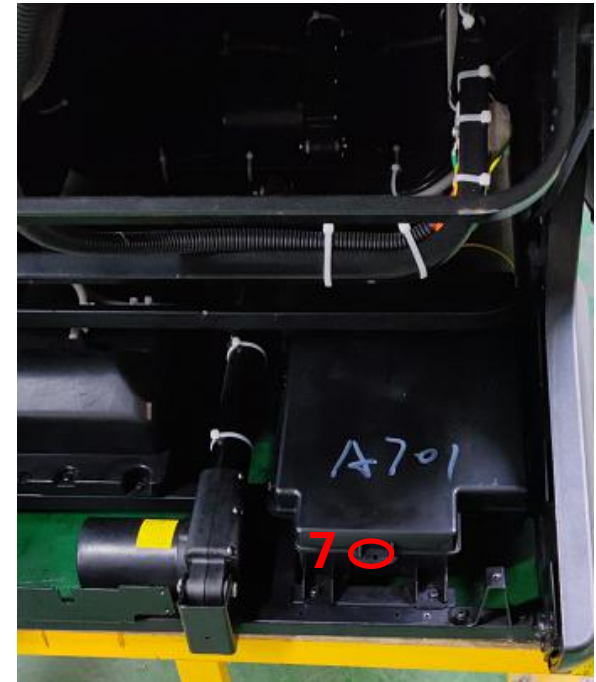

C

C. Remove the screw 7 in Figure C and remove the upper cover of the drive box

5.4. Schematic diagram of capsule disassembly



A

A. Remove the left and right screws of armrest in Figure A

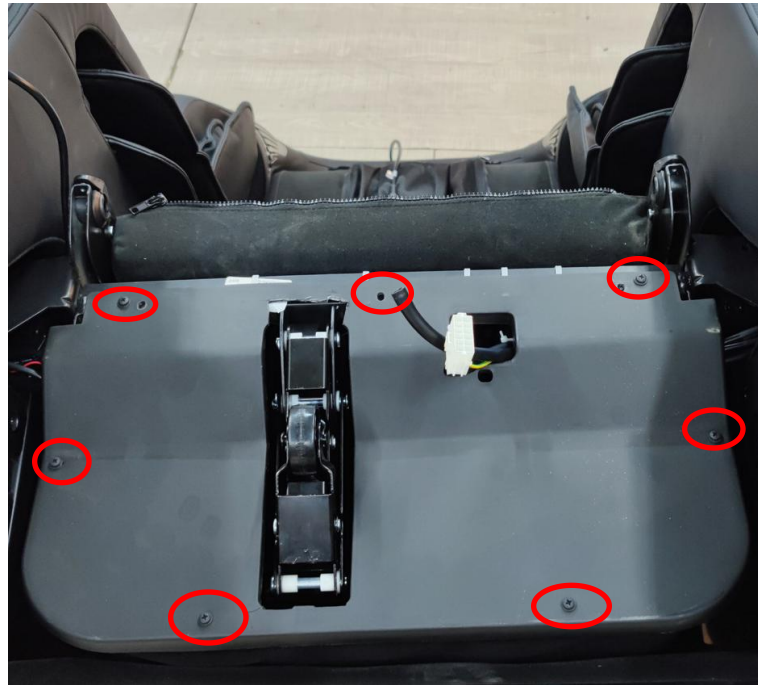

B

B. Remove the 7 screws of the sealing board in Figure B



C

**C, Circle the figure C to the left and right
Remove plug-in, air hose and tie**

5.5. Schematic diagram of capsule disassembly



A

A. Plug-in, separation



B

B. Remove the left and right fixing screws on the inner side of the capsule.

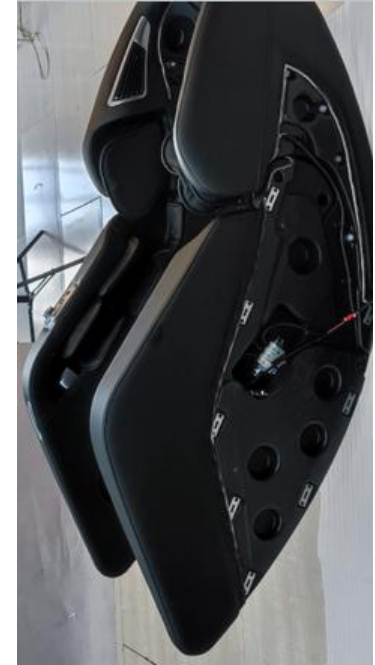

C

C. Lift up capsule to remove it

5.6 Schematic diagram of side cover disassembly



A

A. Remove two screws



B

B. Remove two screws

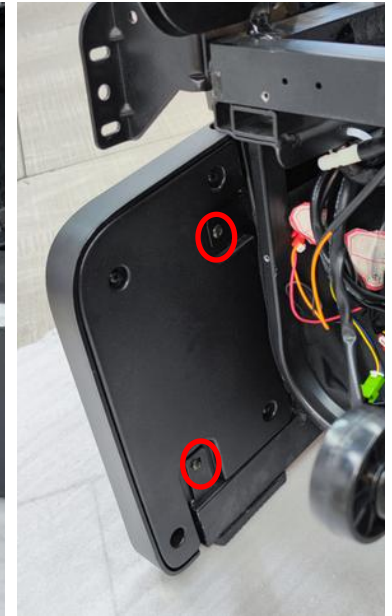

C

**C. Remove the two screws on the outside.
Remove the side cover**

5.6. Disassembly Schematic Diagram of Backup Assembly



A

A. Remove the screws on the fixed block of the belt

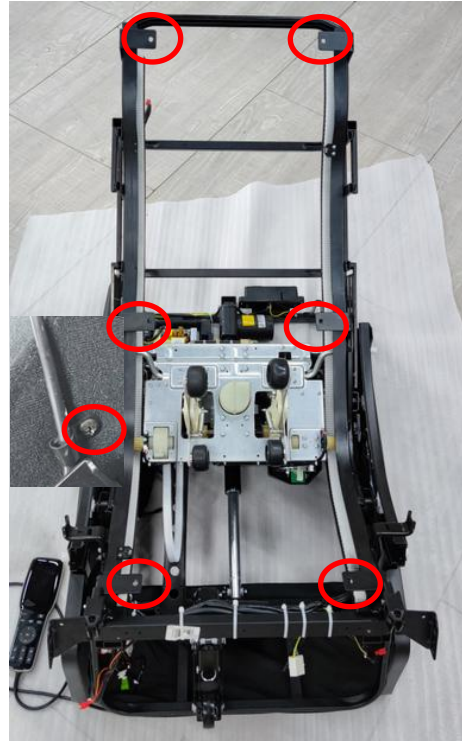

B

B. Remove the fixing screws of the wiring harness



C

C. Remove the rack frame cover

5.7. Disassembly Schematic Diagram of Manipulator Assembly



A

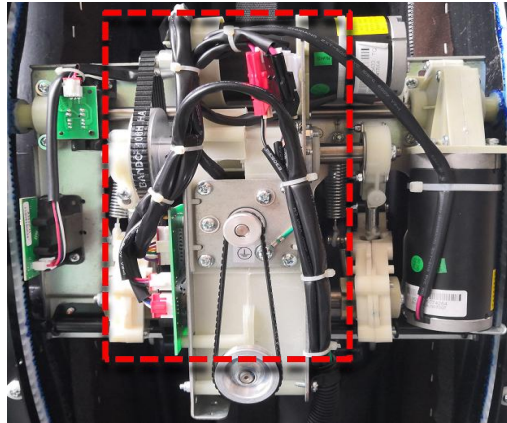

B



C

A. Remove the screws in the red rings on both sides of the backrest steel frame

B. Separate the tie in the red circle and remove the ground wire screw

C. Take it out and separate it from the chair frame

5.8. Schematic diagram of speaker cover disassembly



A



B



C

A. slightly tilt the inner side of the decorative strip with a straight screwdriver

B. Remove 3 pieces, take off the speaker cover of the car buckle

C. Remove three fixing screws

5.9. Schematic diagram of upper arm airbag disassembly



A

A. Unzip Figure A



B

B. Remove the screws



C

C, Separate that air hose

5.10. Side Cover Assembly Disassembly Schematic Diagram



A

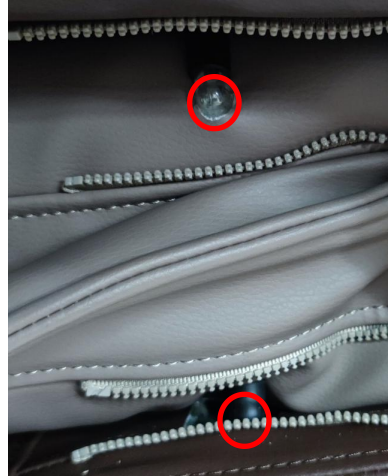

B



C



D

A. Unzip

B. take out the air hose

C. Take out the four buttons of the fixing holster

D. Remove the airbag

5.11. Disassembly Schematic Diagram of Shortcut Key Assembly

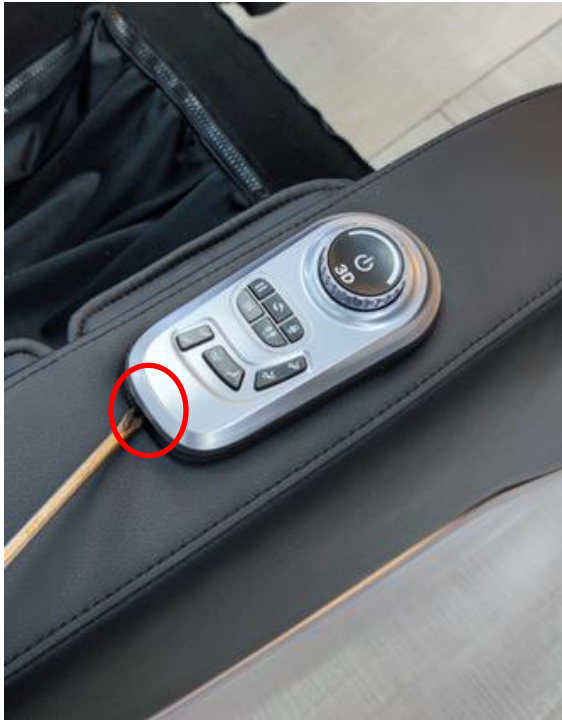

A



B



C

A. Tilt the inner side of the decorative strip with a straight screwdriver slightly

B. Separate the key board plug-in

C. Remove the armrest shortcut button

5.12. Schematic diagram of remov armrest cover



A



B



C

A. Tilt the inner side of the decorative strip with a straight screwdriver slightly to separate the buckle

B. Separate the LED light plug-in as shown in Figure B

C. Separate the air hose and remove fixing screws on the armrest to separate it

5.13. Schematic diagram of heart rate monitoring and disassembly



A

A. Put the straight screwdriver into the inner side of the edge of the outer cover and slightly tilt it to remove the outer cover by hand

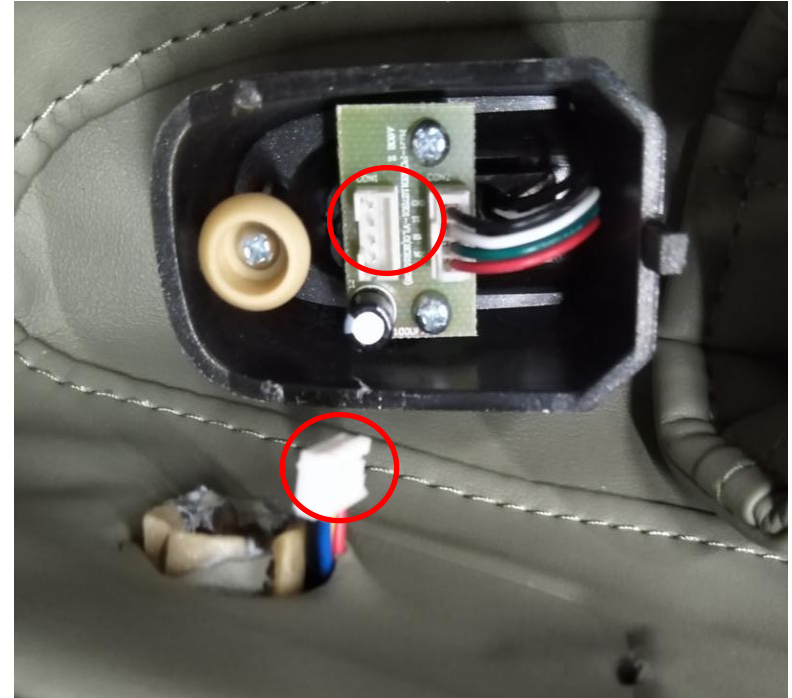

B

B. Remove the plug-in

5.14. Schematic diagram of disassembly of backrest electric cylinder

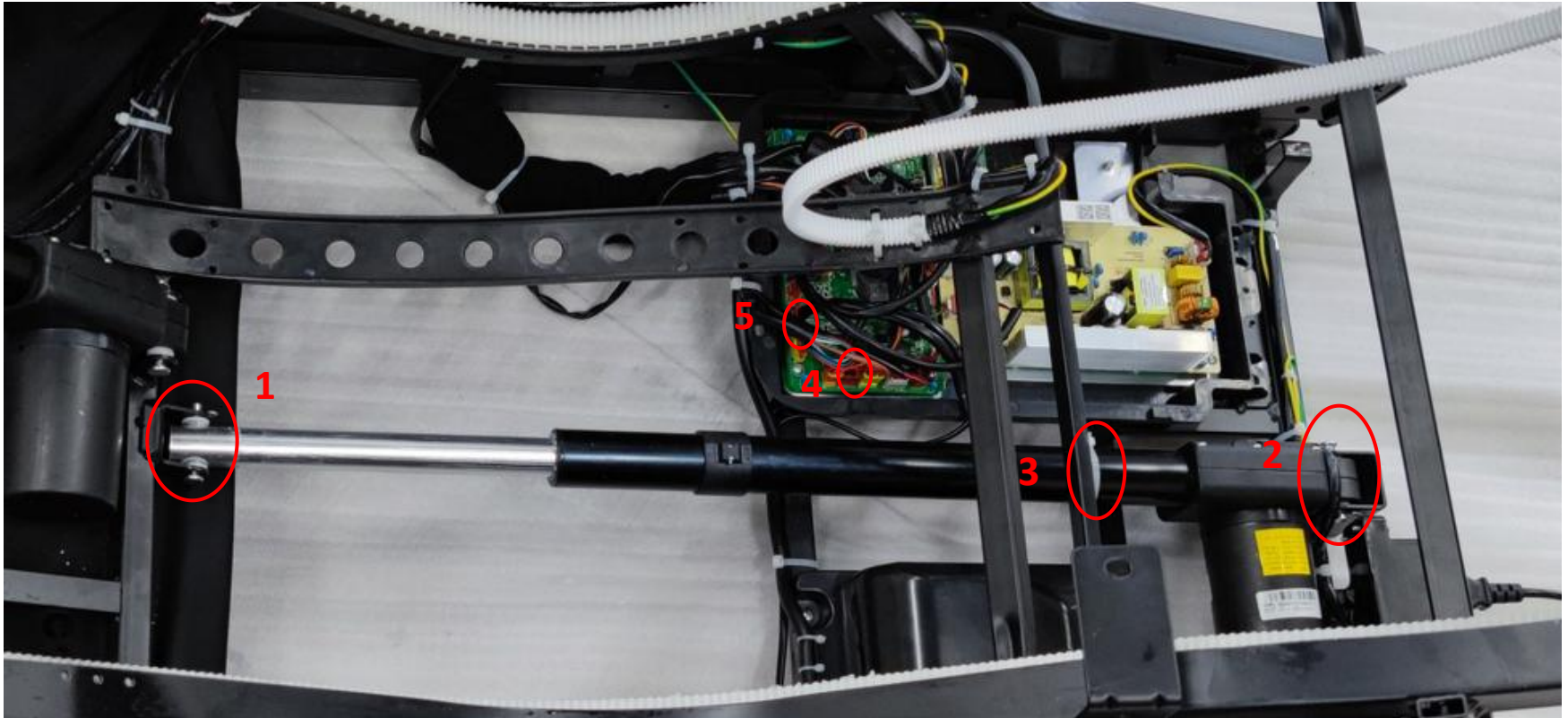

1. Remove the tie as figure 3, and take out the five red plugs at the area of the electric cylinder 4

2. Remove the R-shaped bolt and pin shaft at area 1 and 2 to take out the electric cylinder

5.15. Schematic diagram of disassembly of backrest electric cylinder

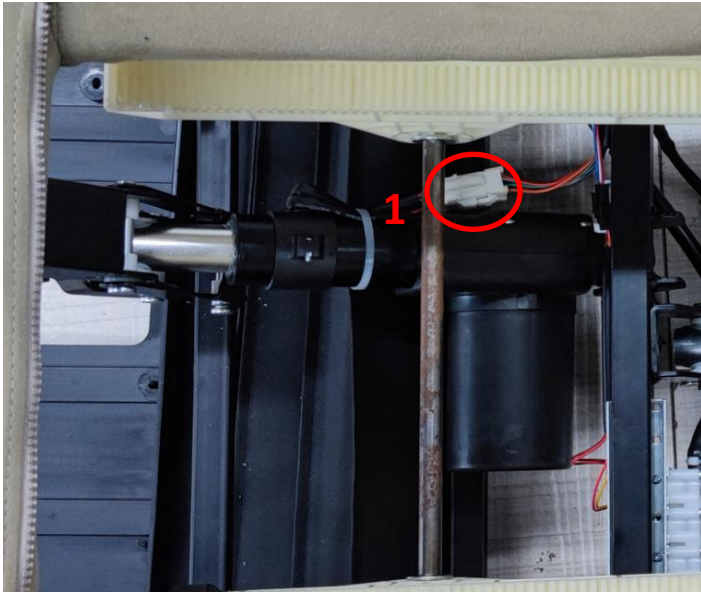

A

A. Remove the tie at the position 1 and pull out the plug of the electric cylinder

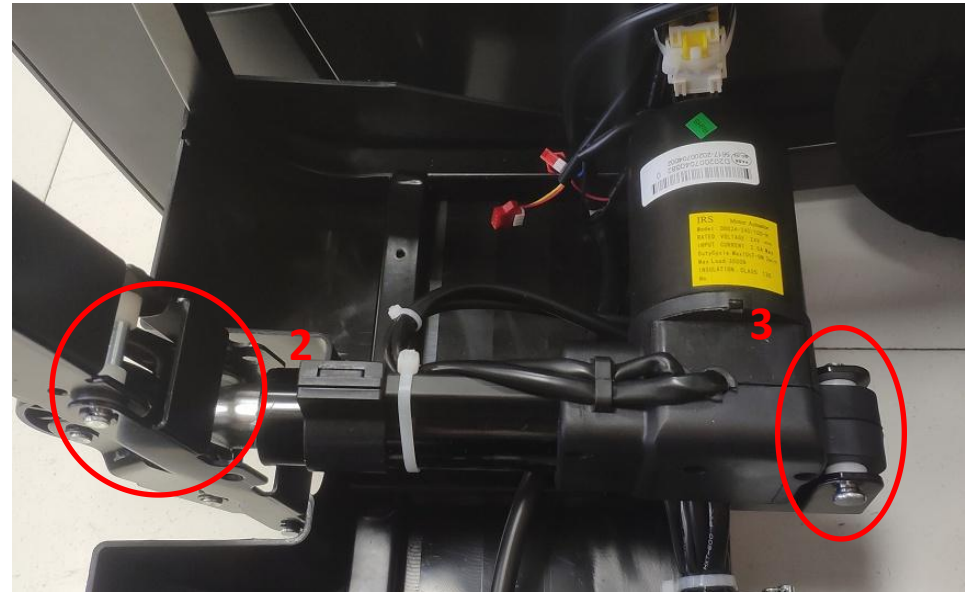

B

B. Remove the R-shaped bolt and pin shaft at the position 2 ~ 3 and take out the electric cylinder

5.13. Schematic diagram of disassembly and assembly of upper and lower leg



A

A. Remove the 4 screws

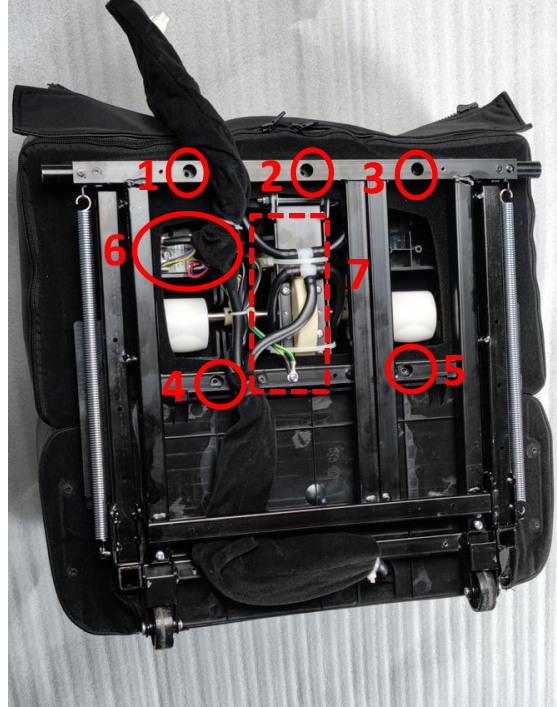

B

B. Remove the 1 ~ 5 screws, take out the plug-in and air hose in 6 ~ 7



C

C. Separate the upper leg kneading assembly.

5.14. Schematic diagram of disassembly and assembly of calf roller

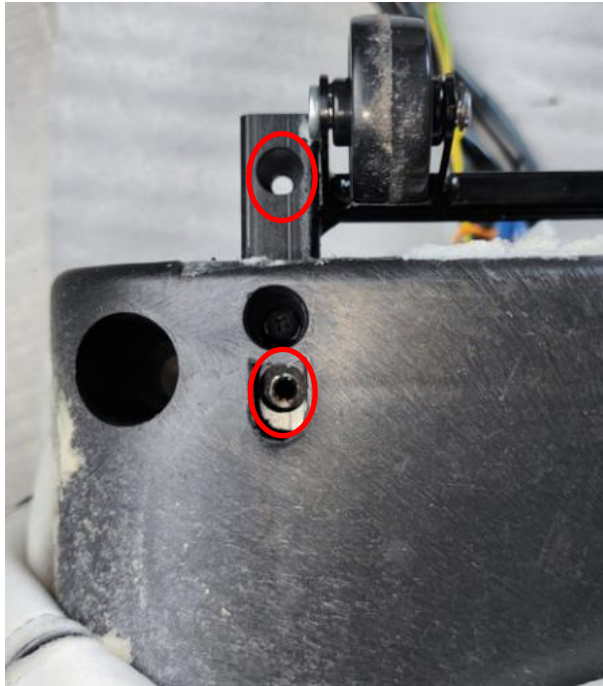

A

A. Remove the left and right 4 screws



B

B. Remove the 4 screws at bottom



C

C. Unzip the zip and remove the cover

5.15. Schematic diagram of foot motor disassembly

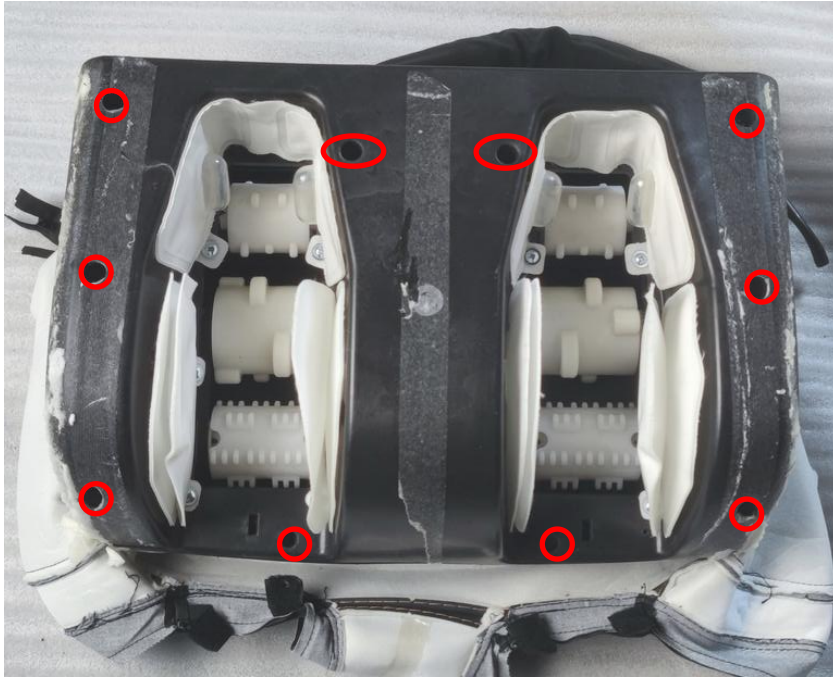

A

A. Remove the 10 screws and separate the upper cover and base

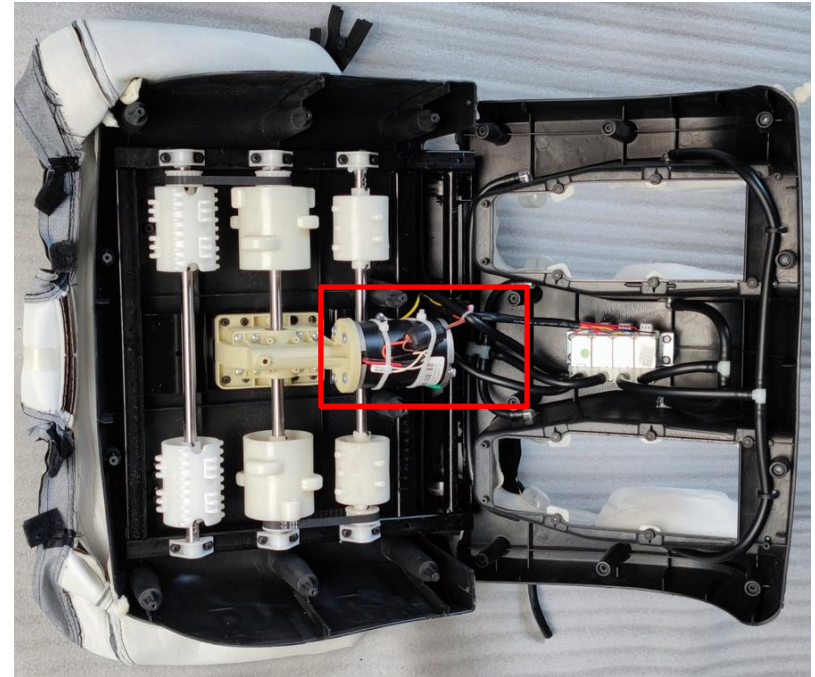

B

B. Remove the screws and tie as shown above and take out the motor

Product error code

Acro

6.1.Error code (LC mode entry method: key combination: press the lower leg + backrest + lying down key at the same time, and then press the menu key)

Display	Malfunction	Possible cause	Trouble shooting
E0	The upper and lower limit switches of the manipulator detect at the same time	<ol style="list-style-type: none">1. The upper and lower limit switch lines are not connected well.2. The upper and lower limit switches are damaged (one or two).	Check whether the relevant accessories and wiring harness are in good condition, and reorganize and replace them
E1	The position signal of up and down walking turns is not detected in unit time	<ol style="list-style-type: none">1. The upper and lower position signal lines are not connected well.2. The walking detection code wheel collides with the deflection detection photoelectric pair tube.3. Move the motor up and down.4. Moving the motor drive circuit up and down the motherboard.5. Overload or other reasons make the up-and-down moving motor unable to work normally.	Check whether the relevant accessories and wiring harness are in good condition, and reorganize and replace them
E2	The machine does not detect upper or lower limit signals	<ol style="list-style-type: none">1. Overload or other reasons make the running speed of the up-and-down moving motor slow.2. The upper and lower limit switches are damaged.	Check whether the relevant accessories and wiring harness are in good condition, and reorganize and replace them
E3	Kneading width can not be detected	<ol style="list-style-type: none">1, kneading width detection photoelectric pipe damage (one or two).2. Failure of kneading motor.3. Kneading drive circuit problem.4. Overload or other reasons make the motor unable to work normally.	Check whether the relevant accessories and wiring harness are in good condition, and reorganize and replace them
E4	The number of turns of the calf lifting motor cannot be detected	<ol style="list-style-type: none">1. The number of laps detected that Hall was damaged.2. Motor failure.3. Motor drive circuit problem.4. Overload or other reasons make the motor unable to work normally.	Check whether the relevant accessories and wiring harness are in good condition, and reorganize and replace them

Product error code

Acro

6.2. Error code (LC mode entry method: key combination: press the lower leg + backrest + lying down key at the same time, and then press the menu key)

Display	Malfunction	Possible cause	Troubleshooting
E5	The number of turns of backrest lifting motor cannot be detected	<ol style="list-style-type: none">1. The number of laps detected that Hall was damaged.2. Motor failure.3. Motor drive circuit problem.4. Overload or other reasons make the motor unable to work normally.	Check whether the relevant circuits, wiring harnesses and plug-ins are in good condition, and reorganize or replace them
E6E8	The calf does not rise or fall	<ol style="list-style-type: none">1. The upper and lower limit switch lines are not connected well.2. The upper and lower limit switches are damaged (one or two).3. Heavy or other reasons make the motor run slowly.	Check whether the relevant circuits, wiring harnesses and plug-ins are in good condition, and reorganize or replace them
E7	Upper and lower limit signals are detected at the same time when the backrest is lifted and lowered	<ol style="list-style-type: none">1. The upper and lower limit switch lines are not connected well.2. The upper and lower limit switches are damaged (one or two).	Check whether the relevant circuits, wiring harnesses and plug-ins are in good condition, and reorganize or replace them
A5	Error detection of foot roller motor drive circuit	<ol style="list-style-type: none">1, the foot roller motor drive circuit circuit problems.2. The foot roller motor fails, resulting in excessive current.3. Overload or other reasons cause the motor to lock up and cause excessive current.	Check whether the relevant circuits, wiring harnesses and plug-ins are in good condition, and reorganize or replace them
E9	No upper limit or lower limit signal was detected for backrest lifting	<ol style="list-style-type: none">1. Heavy or other reasons make the motor run slowly.2. The upper and lower limit switches are damaged.	Check whether the relevant circuits, wiring harnesses and plug-ins are in good condition, and reorganize or replace them

6.3. Error code (LC mode entry method: key combination: press the lower leg + backrest + lying down key at the same time, and then press the menu key)

Display	Malfunction	Possible cause	Troubleshooting
EA	Flap motor drive circuit detection error	<ol style="list-style-type: none"> 1. The problem of beating motor drive circuit. 2. tapping motor failure causes excessive current. 3. Overload or other reasons cause the motor to lock up and cause excessive current. 	Check whether the relevant circuits, wiring harnesses and plug-ins are in good condition, and reorganize or replace them
EB	Error detection of driving circuit of kneading motor	<ol style="list-style-type: none"> 1. Kneading motor drive circuit problem. 2. kneading motor failure, resulting in excessive current. 3. Overload or other reasons cause the motor to lock up and cause excessive current. 	Check whether the relevant circuits, wiring harnesses and plug-ins are in good condition, and reorganize or replace them
EC	Error detection of driving circuit of robot walking motor	<ol style="list-style-type: none"> 1. Drive circuit of traveling motor. 2. The traveling motor fails, resulting in excessive current. 3. Overload or other reasons cause the motor to lock up and cause excessive current. 	Check whether the relevant circuits, wiring harnesses and plug-ins are in good condition, and reorganize or replace them
ED	Error detection of drive circuit of leg lifting motor	<ol style="list-style-type: none"> 1. The problem of driving circuit of calf lifting motor. 2. The calf lifting motor fails, resulting in excessive current. 3. Overload or other reasons cause the motor to lock up and cause excessive current. 	Check whether the relevant circuits, wiring harnesses and plug-ins are in good condition, and reorganize or replace them
EE	Error detection of driving circuit of backrest lifting motor	<ol style="list-style-type: none"> 1. Drive circuit of backrest lifting motor. 2. The backrest lifting motor fails, resulting in excessive current. 3. Overload or other reasons cause the motor to lock up and cause excessive current. 	Check whether the relevant circuits, wiring harnesses and plug-ins are in good condition, and reorganize or replace them

1. The whole machine does not work
2. The movement does not walk
3. Kneading doesn't work
4. Tapping doesn't work
5. Telescoping does not work
6. Calf kneading doesn't work
7. USB does not work
8. The sole roller does not work
9. The backrest electric cylinder does not work
10. The calf electric cylinder does not work
11. Backrest heating does not work
12. A certain group of airbags does not work
13. Bluetooth MP3 does not work
14. Intelligent voice control does not work



7.1 、 The chair doesn' t work



figure 1

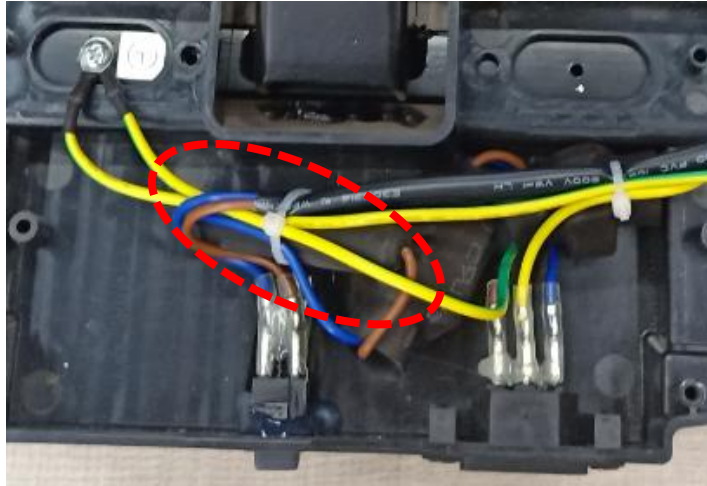

figure 2

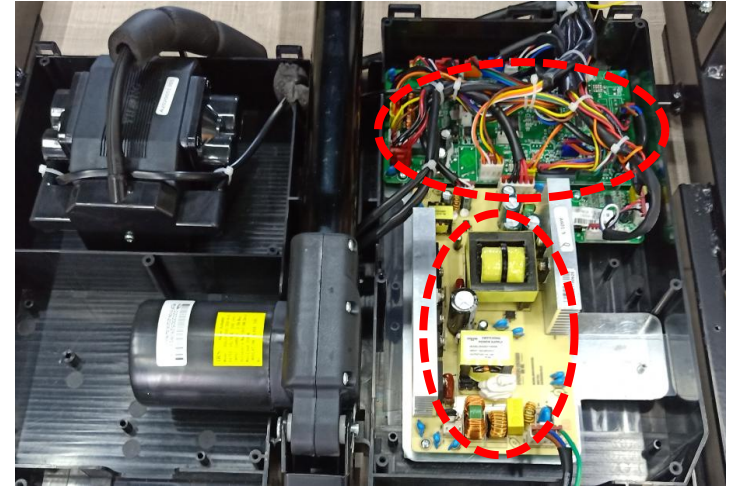

figure 3

Fault diagnosis and maintenance :

- A. The manual controller broken and cannot be turned on, change a new one (figure1)**
- B. Fuse burn, it is usually caused by short circuit of load, change a new drive board and replace a fuse (figure 2) ;**
- C. Check the 24V/5VA voltage output from the power board is it normal. If it is abnormal, the power board is broken (figure3).**

Normal means the power supply is normal. The problem might be caused by the drive board

7.2. The manipulator cannot walk up and down

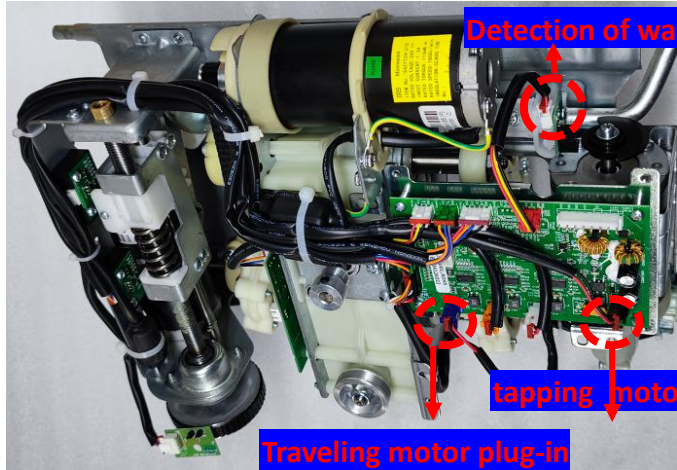

Figure 1

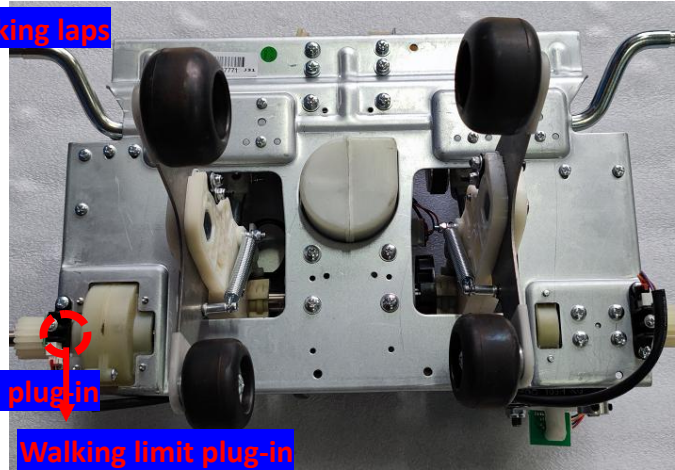

Figure 2

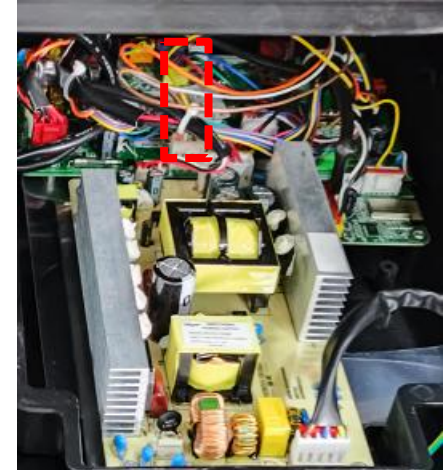

Figure 3

Error judgment and maintenance:

- A. First, check whether the backrest wiring harness has poor contact or plug-in falls off;
- B. Judging whether the motor is damaged, the power supply of the motor can be used to judge the quality of the motor;
- C. Checking whether the travel circle number detection board is damaged or the optocoupler is blocked (Figure 1);
- D. Judging whether the upper and lower limit detection boards are damaged and whether the upper and lower magnets fall off (Fig. 2);
- E. The drive board plug-in is loose or damaged (Fig. 3);

7.3. The kneading function does not work

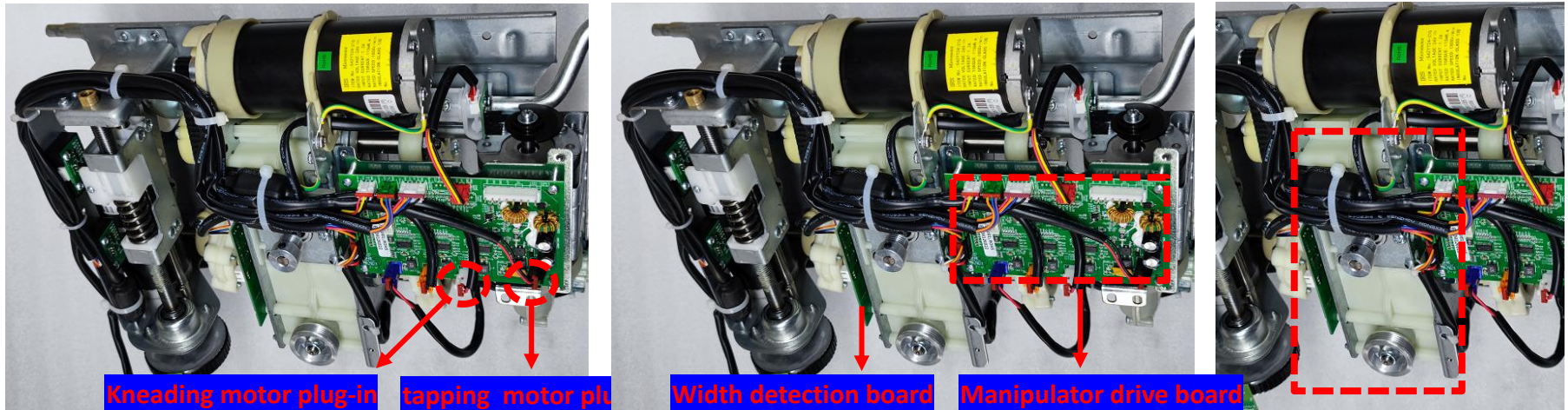

Figure 1

Figure 2

Figure 3

Error judgment and maintenance:

- First, check whether the wiring harness of the manipulator drive board has poor contact or the plug-in falls off (Figure 2);
- Judge whether the motor is damaged, you can use the power supply of beating the motor to judge whether the motor is good or bad (Figure 1);
- Check whether the width detection board is damaged (Fig. 2);
- Judging whether the driving board is damaged by substitution method (Fig. 2);
- Turn the kneading passive wheel by hand to see if it feels tight. If so, replace the kneading worm gear box assembly (Figure 3)

7.4. The tapping function does not work

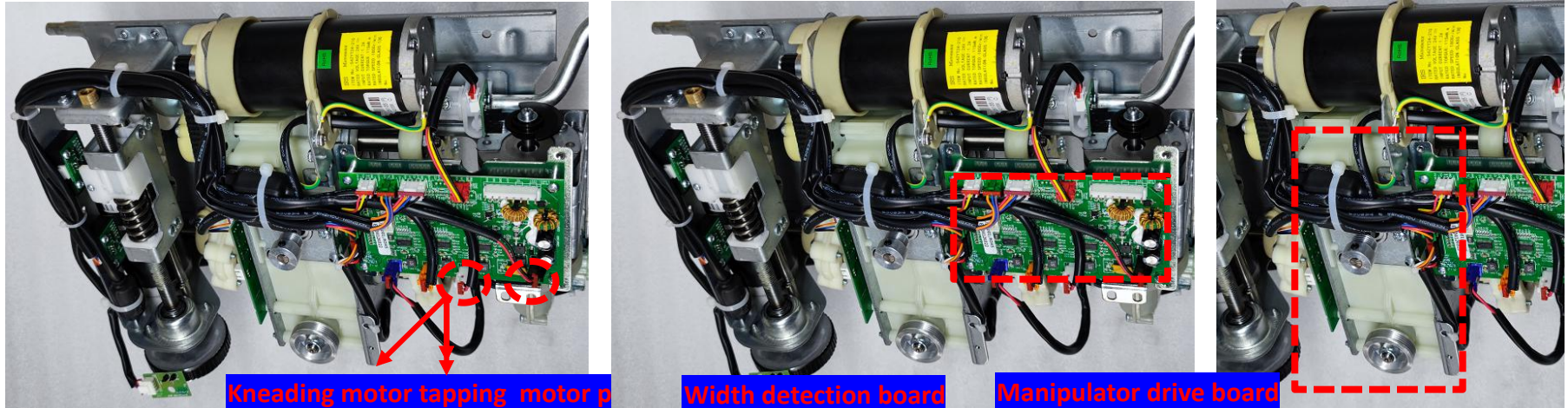

Figure 1

Figure 2

Figure 3

Error judgment and maintenance:

- A. First, check whether the wiring harness of the manipulator drive board has poor contact or the plug-in falls off (Figure 2);
- B, Judge whether the motor is damaged, you can use the power supply of kneading motor to judge whether the motor is good or bad (Figure 1);
- C, Judging whether the driving board is damaged by substitution method (Fig. 2);
- D. Check whether the kneading belt falls off (Figure 3);

7.5. The stretch function does not work

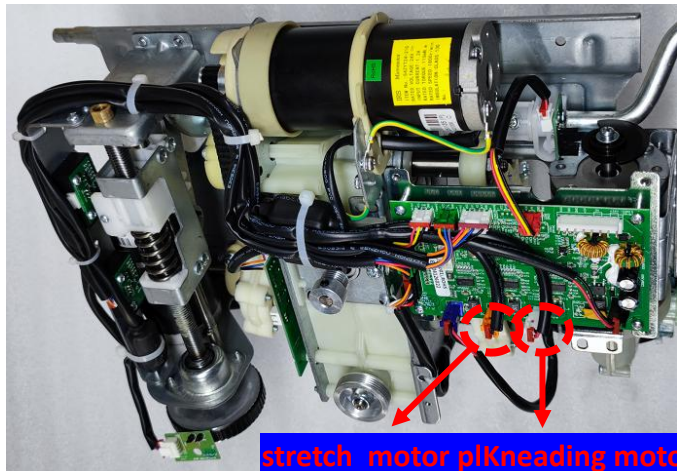

Figure 1

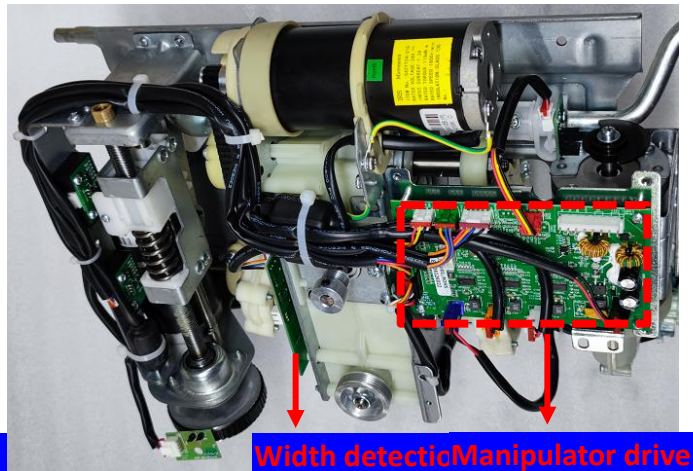

Figure 2

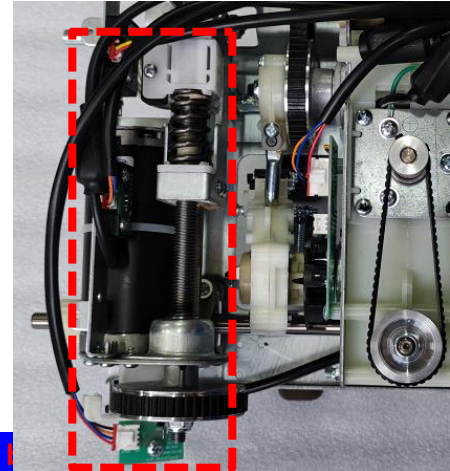

Figure 3

Error judgment and maintenance:

- A. First, check whether the wiring harness of the manipulator drive board has poor contact or the plug-in falls off (Figure 2);**
- B, Judge whether the motor is damaged, you can use the power supply of kneading motor to judge whether the motor is good or bad (Figure 1);**
- C. Judging whether the driving board is damaged by substitution method (Fig. 2);**
- D. Check whether the stretch belt and stretch detection plug-in fall off (Figure 3);**

7.6. The kneading motor does not work

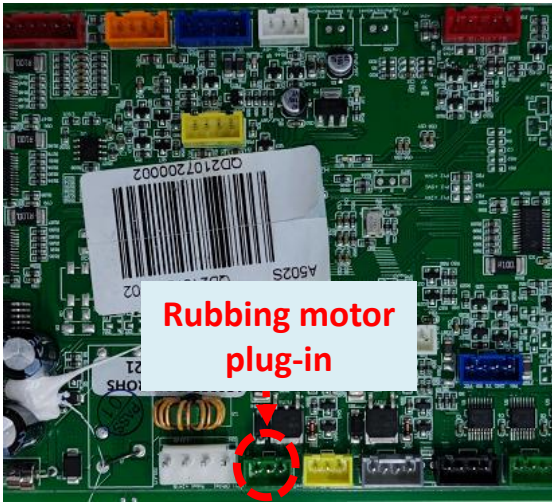

Figure 1

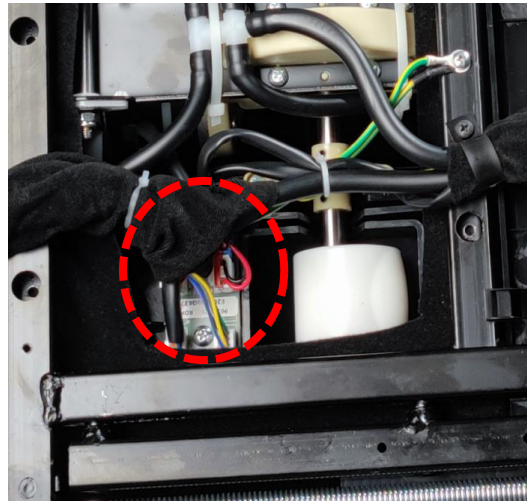

Figure 2

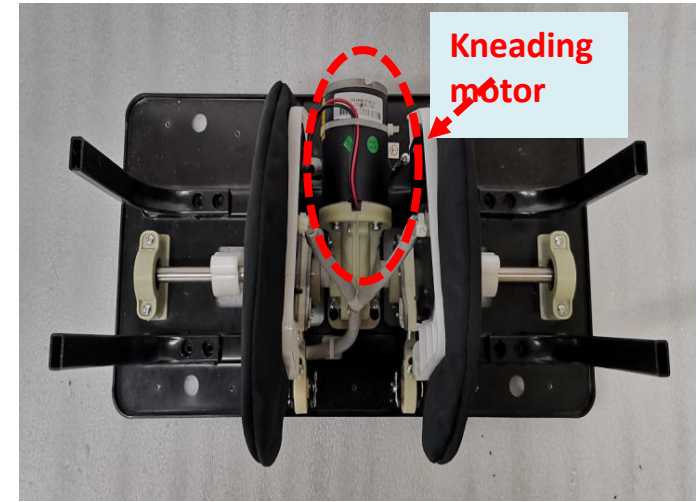

Figure 3

Error judgment and maintenance:

First, check whether the driving board kneading plug-in is loose and whether there is DC24V voltage output (Figure 1);

If the driving board kneading plug-in is not loose, and DC24V voltage output normal, check whether the calf adapter board plug-in is loose (Figure 2), if those all are ok, change a new kneading motor to try (Fig. 3);

If all above is normal, consider replacing the drive board (Figure 1);

7.7, USB function does not work

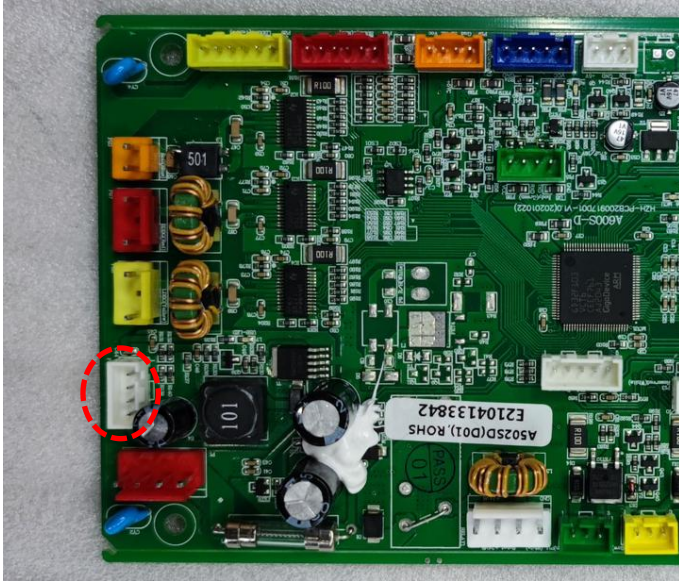

**Figure
1**

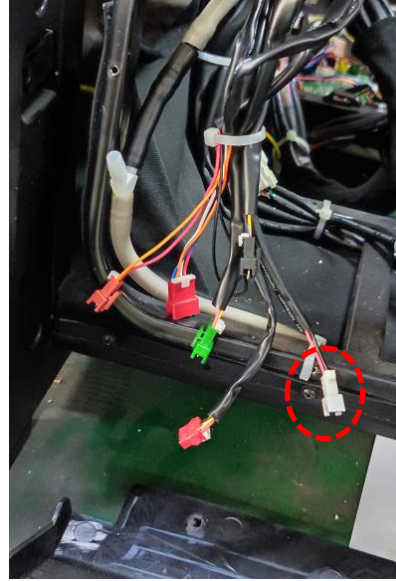

**Figure
2**



**Figure
3**

error judgment and maintenance:

- A. First, check whether the wiring harness of the moving board has poor contact or the plug-in falls off (Figure 1);
- B, Checking (Fig. 2) whether the USB adapter is loose and falls off;
- C, Checking (fig. 3) whether the USB board plug-in is loose and falls off;
- D. If the wiring harness is good, use multimeter to measure whether the plug-in has voltage output (Figure 3) ; If it has, change the USB board, if not, change a new drive board

7.8. The sole roller does not work

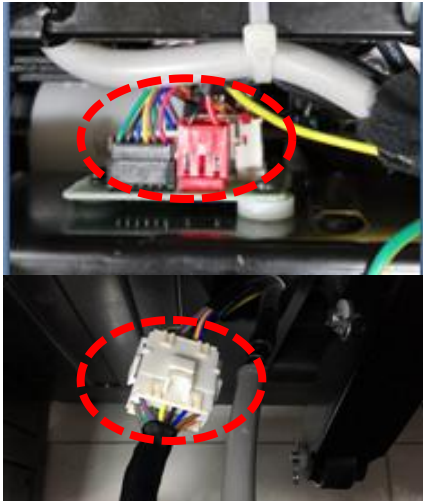

Figure 1

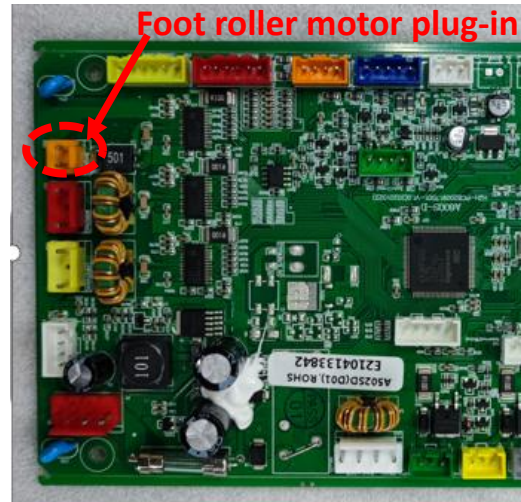

Figure 2

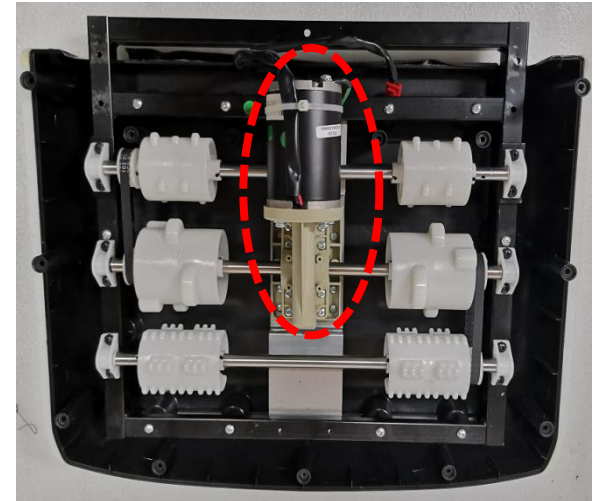

Figure 3

Error judgment and maintenance:

- A. Check whether the connecting wiring harness between the lower leg and the host is in poor contact and whether there is DC24V output (under Figure 1);
- B. If there is no voltage output, check whether the plug-in on the drive board is loose and whether there is voltage output, If not, consider replacing the drive board (Figure 2);
- C. If above is normal, check whether the plug-in on the calf adapter board is abnormal (Figure 1);
- D. If all above is normal. If the wiring harness is all right, consider replacing the sole roller motor (Figure 3);

7.9. The backrest electric cylinder does not work

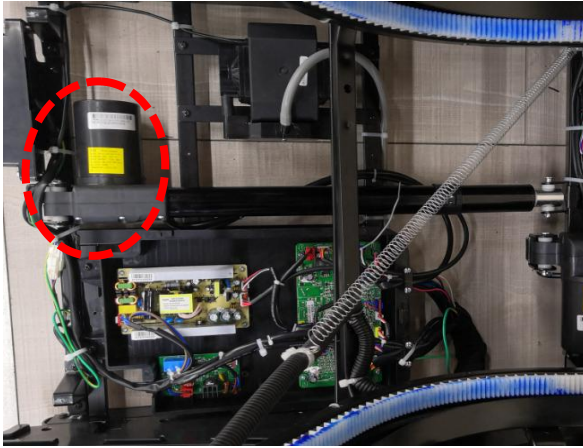

Figure 1

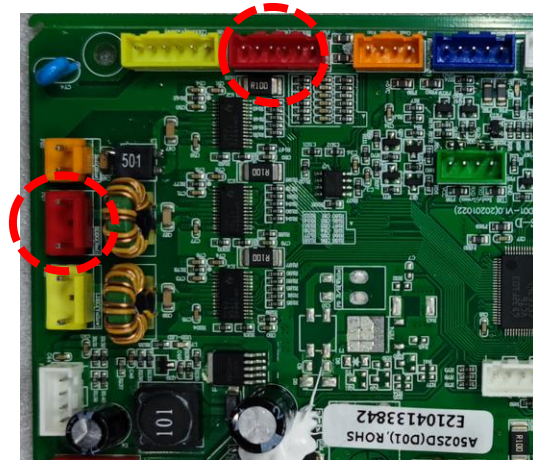

Figure 2

error judgment and maintenance:

A. First, press and hold the control button of the electric cylinder, listen to the buzzer sound "beep, beep," and after loosening, send out two "drip" sounds to judge that the signal of the electric cylinder has not been detected, and the electric cylinder may be damaged or the drive board may be damaged, replace a new one.

B. Replace the non-working electric cylinder plug-in with another working electric cylinder plug-in (note: from the motherboard end), if it still does not work after replacement, which proves that the electric cylinder has been damaged and needs to be replaced. After replacement, the electric cylinder can work, which proves that the motherboard has been damaged and needs to be replaced;

The main reasons that affect the backrest electric cylinder not working: backrest electric cylinder, drive board and wiring harness

7.10, the calf electric cylinder does not work

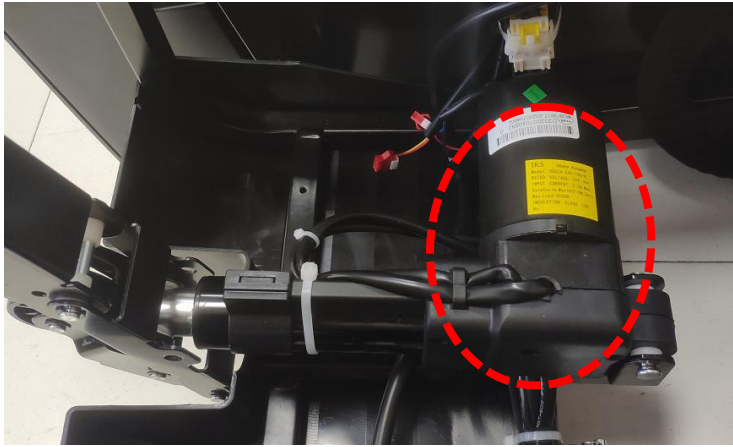

Figure 1

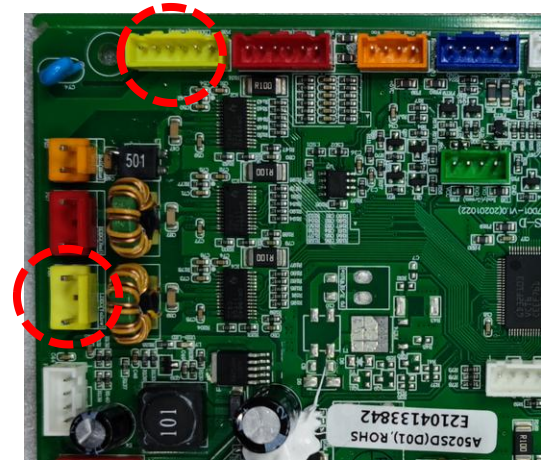

Figure 2

error judgment and maintenance:

A. First, press and hold the control button of the electric cylinder, listen to the buzzer sound "beep, beep," and after loosening, send out two "drip" sounds to judge that the signal of the electric cylinder has not been detected, and the electric cylinder may be damaged or the drive board may be damaged, replace a new one; (Figure 1);

B, The electric cylinder plug-in that does not work and another electric cylinder plug-in that can work (note: from the motherboard end) are exchanged with each other. It still doesn't work after replacement, which proves that the electric cylinder has been damaged and needs to be replaced. After replacement, the electric cylinder can work, proving that the motherboard has been damaged and needs to be replaced (Figure 2);

Main reasons that affect the non-operation of leg electric cylinder: leg electric cylinder, drive board and wiring harness

7.11. Backrest heating does not work



Figure 1

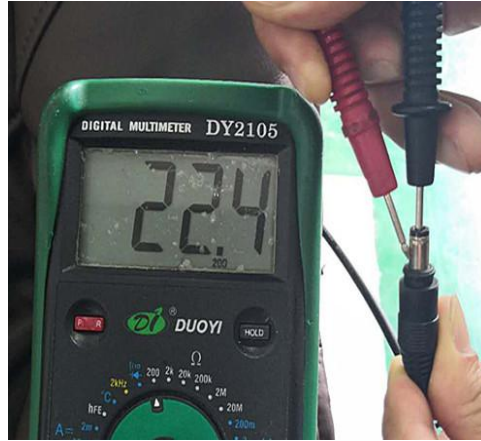

Figure 2

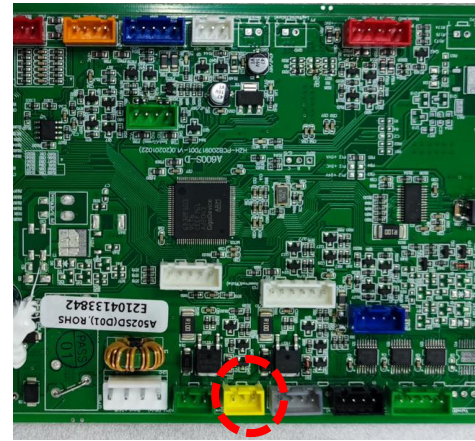

Figure 3



Figure 4

error judgment and maintenance:

A. Check whether the backrest heating wire plug-in is poor contact or falls off (Figure 1);

B, use a multimeter to measure whether there is AC24V voltage in the yellow plug-in of the driving board and the plug-in of the backrest cushion. If there is no AC24V voltage, the driving board might be broken, replace the driving board; (Figure 3)

C, You can also use multimeter to measure the resistance of backrest heating wire as shown in Figure 2. There is a resistance driving line problem, and the backrest heating wire is replaced without resistance; (Figure 4);

The main reasons that affect the backrest heating are backrest heating wire, driving board and wire harness

7.12、 A certain group of airbags does not work

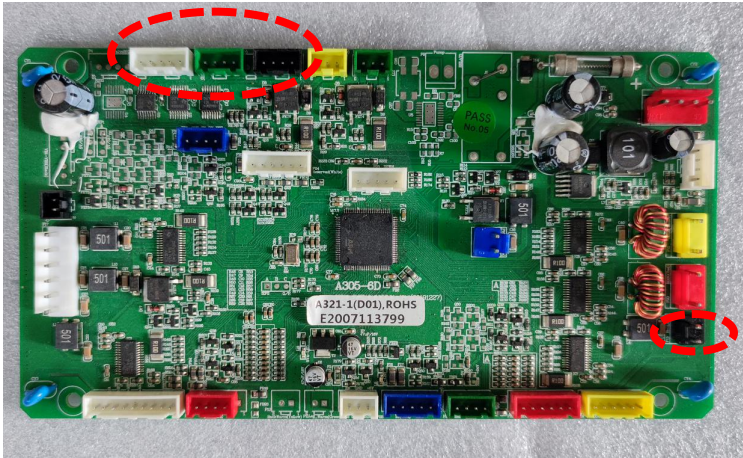

Figure 1

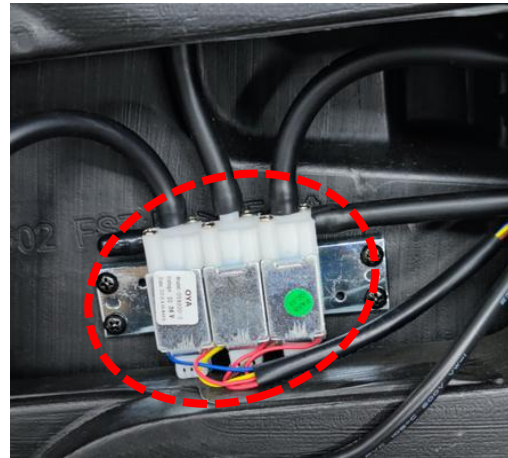

Figure 2



Figure 3

Error judgment and maintenance:

- A. Check whether the air bag is broken and whether the air hose is bent (FIG. 2 and FIG. 3); High probability
- B. The solenoid valve controlling the air pressure of the road is damaged (Figure 2); low probability;
- C. The peripheral circuit controlling the air pressure of the circuit is abnormal, replace the driving board (Figure 1);

The main reason for the airbags does not work: airbags broken, air hose bend, solenoid valve broken

7.13、 Bluetooth MP3 does not work

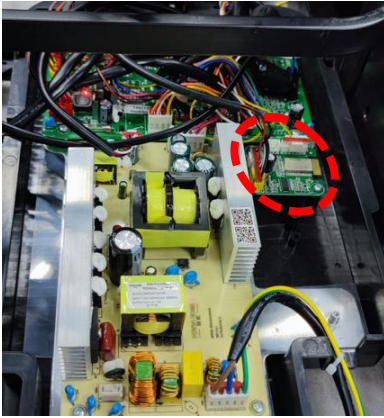

Figure 1

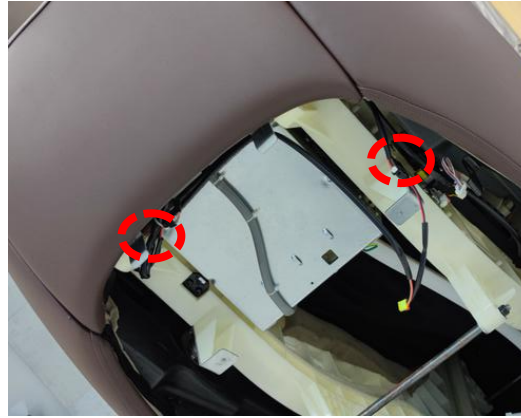

Figure 2



Figure 3

Error judgment and maintenance:

A. If the phone is paired with Bluetooth successfully, check the connection between the wiring harness of the audio Bluetooth and Bluetooth MP3 board.

change a new one (figure 1)

B. Check whether the connection line between audio Bluetooth board and speaker is it connect well (figure 2)

C. If one side speaker does not sound, check the wiring harness and replace the speaker; (figure 3)

The main reason why bluetooth MP3 board does not work : Bluetooth board, wire harness, drive board

7.14、 Intelligent voice control does not work



Figure 1

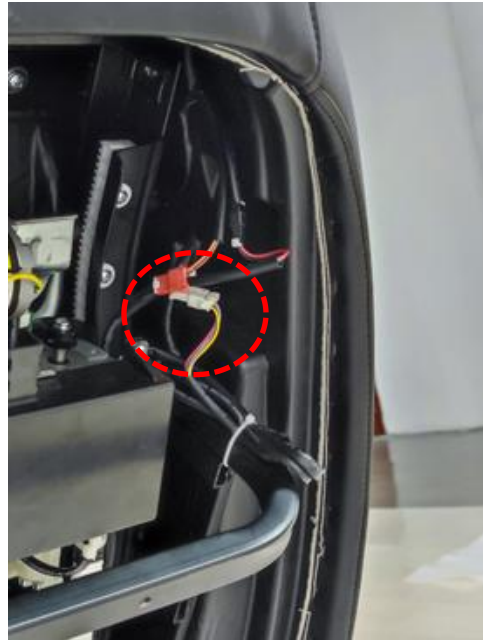

Figure 2

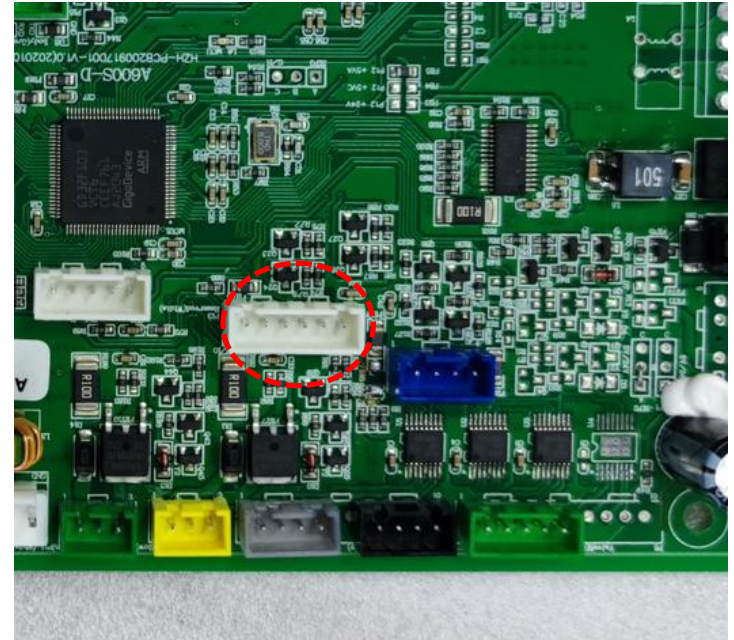

Figure 3

Error judgment and maintenance:

- A、 Start the massage chair function through the voice entry, and listen to whether there is a response to the voice (Figure 1);**
- B、 Voice control does not work, the wiring harness or microphone signal receiving is broken, or the drive board and intelligent voice control board are damaged (FIG. 2 and FIG. 3);**