

Service Manual



Model:Horiozn 4D Pro

Service Dept

Contents

- 1.Product parameters and function introduction
- 2.Structure of massage chair
- 3.Disassembly diagram of the massage chair
- 4.Analysis and Repair of Massage Chair Faults
- 5.Tool list



1. Product parameters and function introduction

- 1.Product Parameter
- 2.Product function
- 3.Tablet description
- 4.Product size

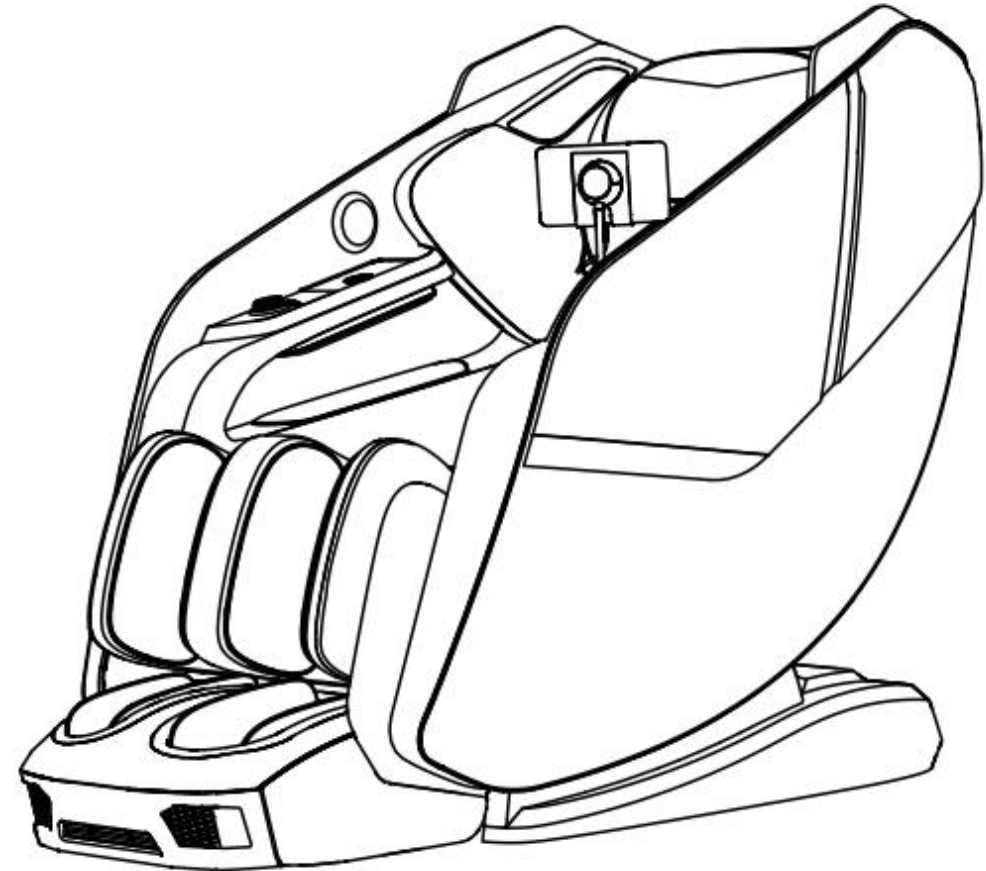

1.1.1·Product Parameter

Product Specification	Product Description
Product name	Massage Chair
Model No.	Horizon 4D Pro
Rated frequency	60HZ
Rated voltage	110V ~
Rated power	180w
Safety design	Class 1
Net weight	291 lbs
Gross weight	343.9 lbs
Product size	64.6*32.7 *46.1

1. 2. 1 • Product function

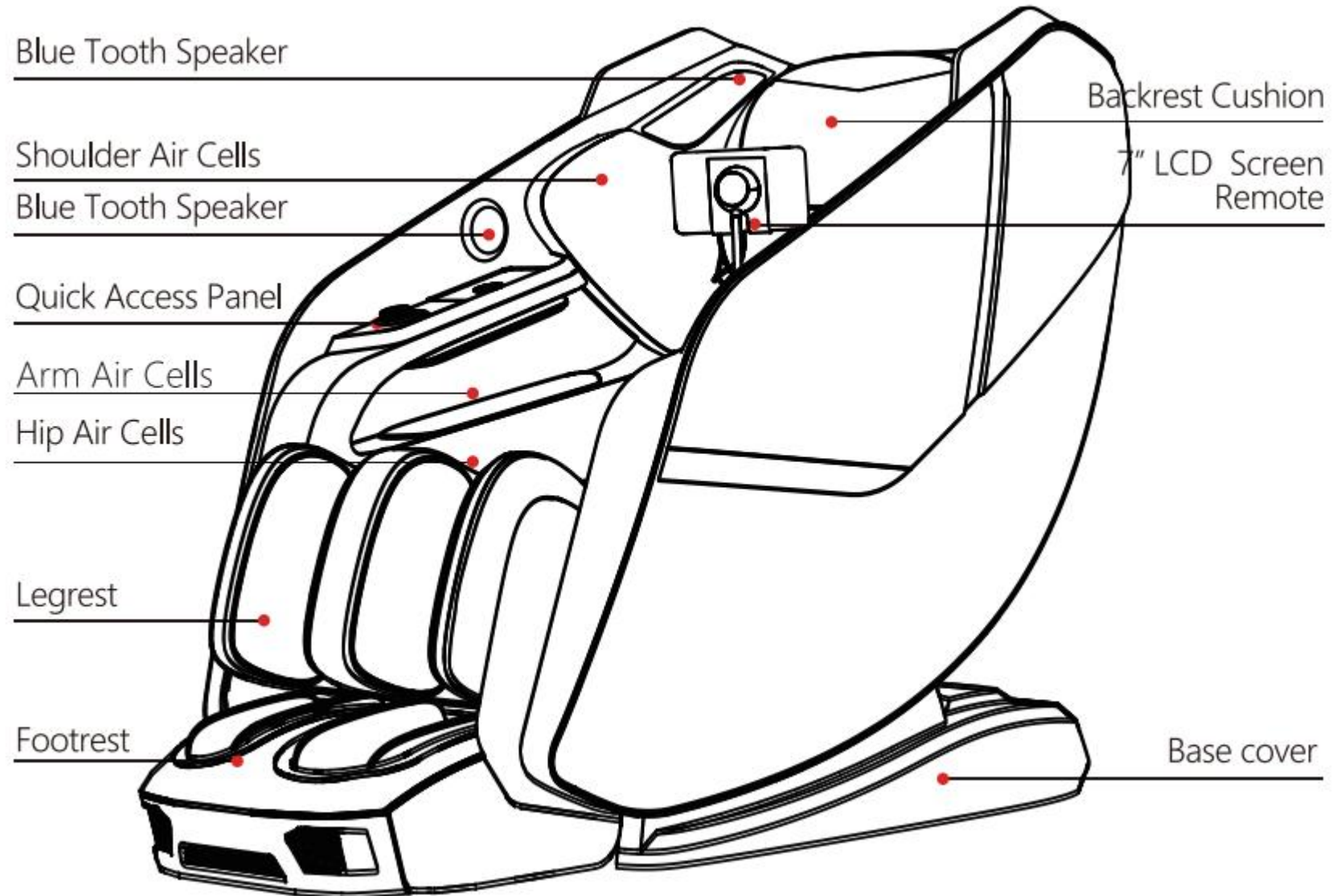

1. 3. 1 • Tablet description



1、 Turn on LCD SCREEN to start massaging.

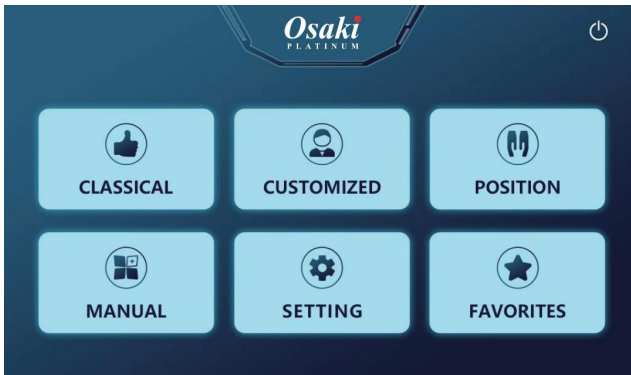

2、 **There are six option on the home page:** CLASSICAL、 CUSTOMIZED、 POSITION、 MANUAL、 SETTING、FAVORITES.



3、 **After selecting the CLASSIC mode, there are 8 programs:**

DEMO (Massage 5 mins only)、 THAI STRETCH、 BODY CIRCULATION、 RELAX、 MORNING CARE、 MIDDAY CARE、 NIGHT CARE、DEEP TISSUE.

1.3.1 • Tablet description



4、 After selecting the **CUSTOMIZED** mode, there are **8 programs**:

EXTENSION、 WOMEN'S HEALTH、 SHIATSU、 MEN'S HEALTH、 OFFICE RELIEF、 SPORTS RECOVERY、 FOOT CARE、 REJUVENATE.



5、 After selecting the **POSITION** mode, there are **8 programs**:

NECK MASSAGE、 NECK AND SHOULDER MASSAGE、 BACK MASSAGE、 LUMBAR MASSAGE、 WAIST & HIP MASSAGE、 LEGS MASSAGE、 UPPER BODY、 LOWER BODY.

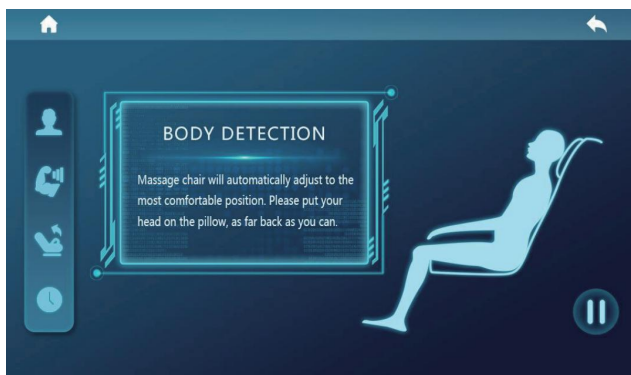

6、 After selecting the automatic massage program, the chair will start conducting a body scan.

To enjoy the most comfortable massage please put your head on the headrest and sit as far back into the chair as you can.

1.3.1 • Tablet description

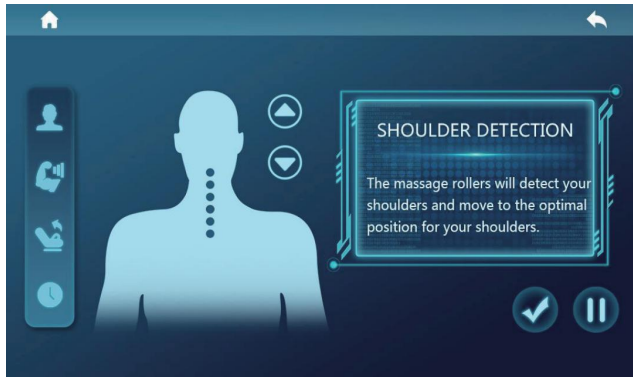

7、 After the body scan, the shoulder detection will begin where the massage rollers will move from the top to the optimal shoulder positions.



8、 After selecting the CUSTOM mode, it will enter the CUSTOM mode page: In this page, you can select the body parts of the air cells massage, such as the FULL BODY, SHOULDER, HAND, WAIST-HIP, LEG-FOOT massage, or you can select the massage action: like KNEADING, PERCUSSION, ACUPRESSURE, FLAP, SLAP, MIXTURE.

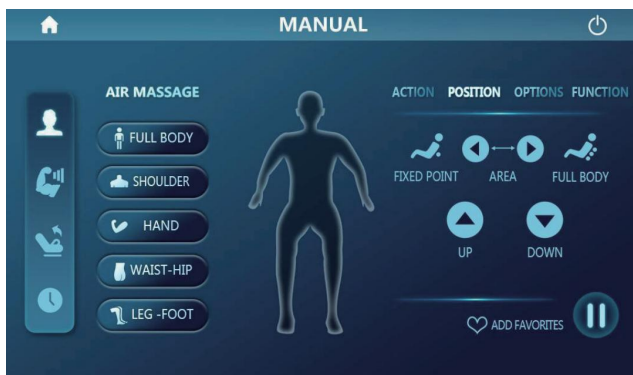

9、 In MANUAL mode message position page, you can control the massage hand position through FIXED POINT, FULL BODY, AREA, UP and DOWN. In "full body" mode, "up" and "down" are invalid.

1. 3. 1 • Tablet description



10、 In MANUAL mode OPTIONS page, you can choose the other functions you may need, such as: HEATING, LEG ROLLING, FOOT ROLLING, RANGE, WIDE, MIDDLE and NARROW.



11、 There are 7 functions: FOOT VIBRATION, HAND ROLLER, HEATING, ROLLING, AIR MASSAGE, 4D FORCE and ADD TO FAVORITES. You can add your favorite massage program into ADD TO FAVORITES.

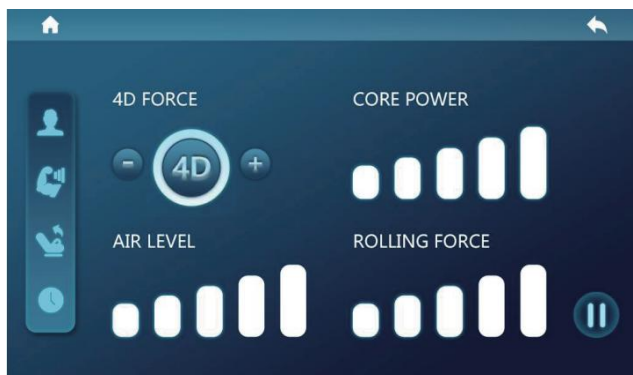

12、 This button to help to control: 4D FORCE, CORE POWER, AIR LEVEL and ROLLING FORCE. Note: some actions are controlled by automatic program, and manual adjustment is invalid at this time.

1. 3. 1 • Tablet description

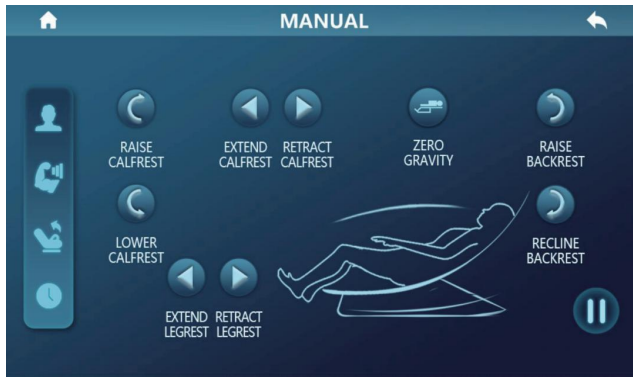

13、 This button to help to control:
 RAISE CALFREST,LOWER CALFREST,EXTEND CALFREST,RETRACT CALFREST,ZERO GRAVITY,RAISE BACKREST,RECLINE BACKREST,EXTEND LEGREST,RETRACT LEGREST.

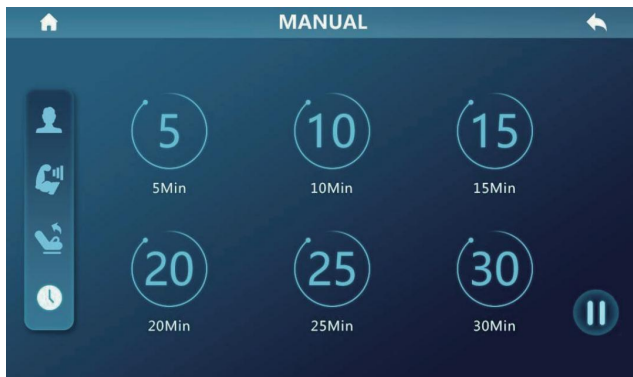

14、 This button to change massage time:
 5Min,10Min,15Min,20Min,25Min,30Min.

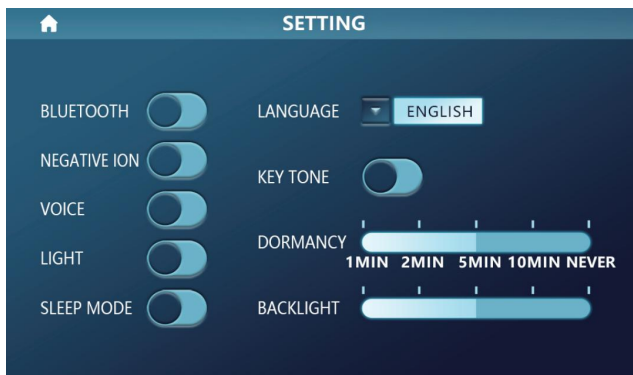

15、 Home page SETTING you can control The BLUETOOTH,LANGUAGE,NEGATIVE ION,KEY TONE,VOICE,DORMANCY,LIGHT,SLEEP MODE,BACKLIGHT.

1.3.1 • Tablet description

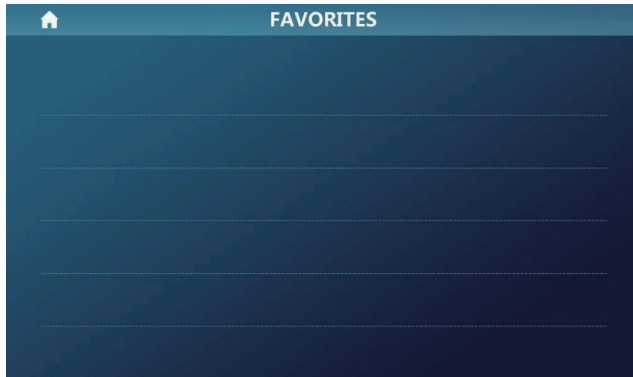

16、 FAVORITES: You can add favorite programs to this page and delete them whenever you'd like.

1.3.2 • Shortcut key

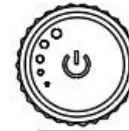
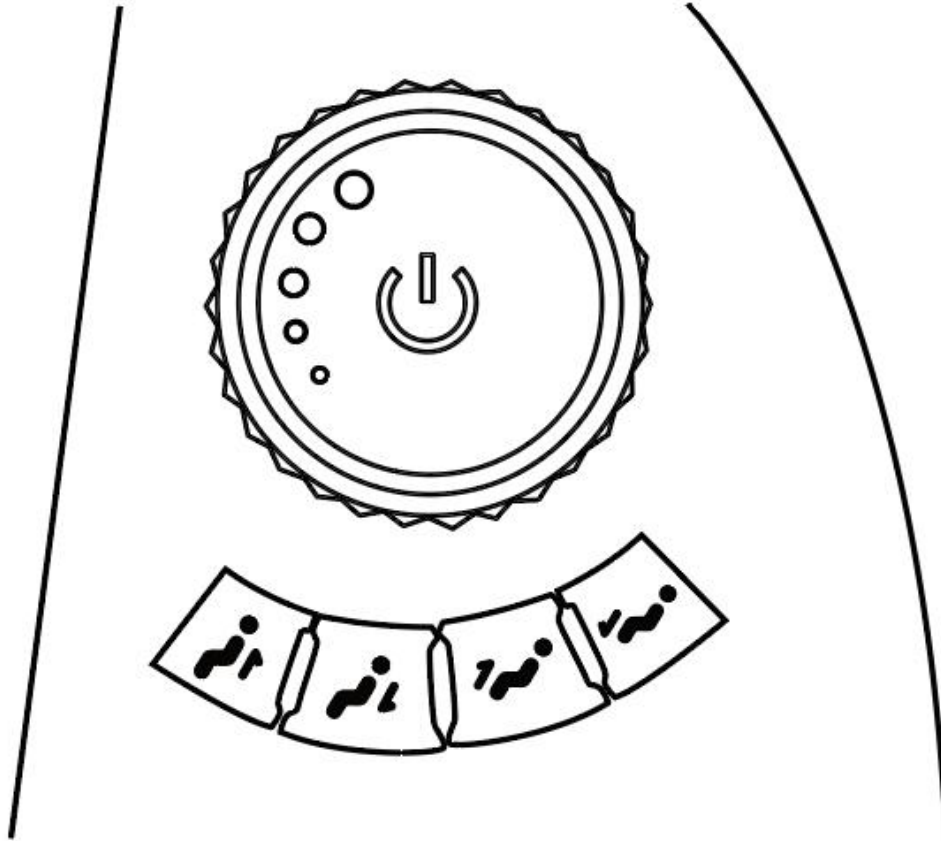

Rotate to adjust back roller force



Click to turn on/off chair



Press and hold to raise backrest



Press and hold to recline backrest



Press and hold to raise calfrest



Press and hold to lower calfrest

1. 4. 1 • Product size

Main body
carton size

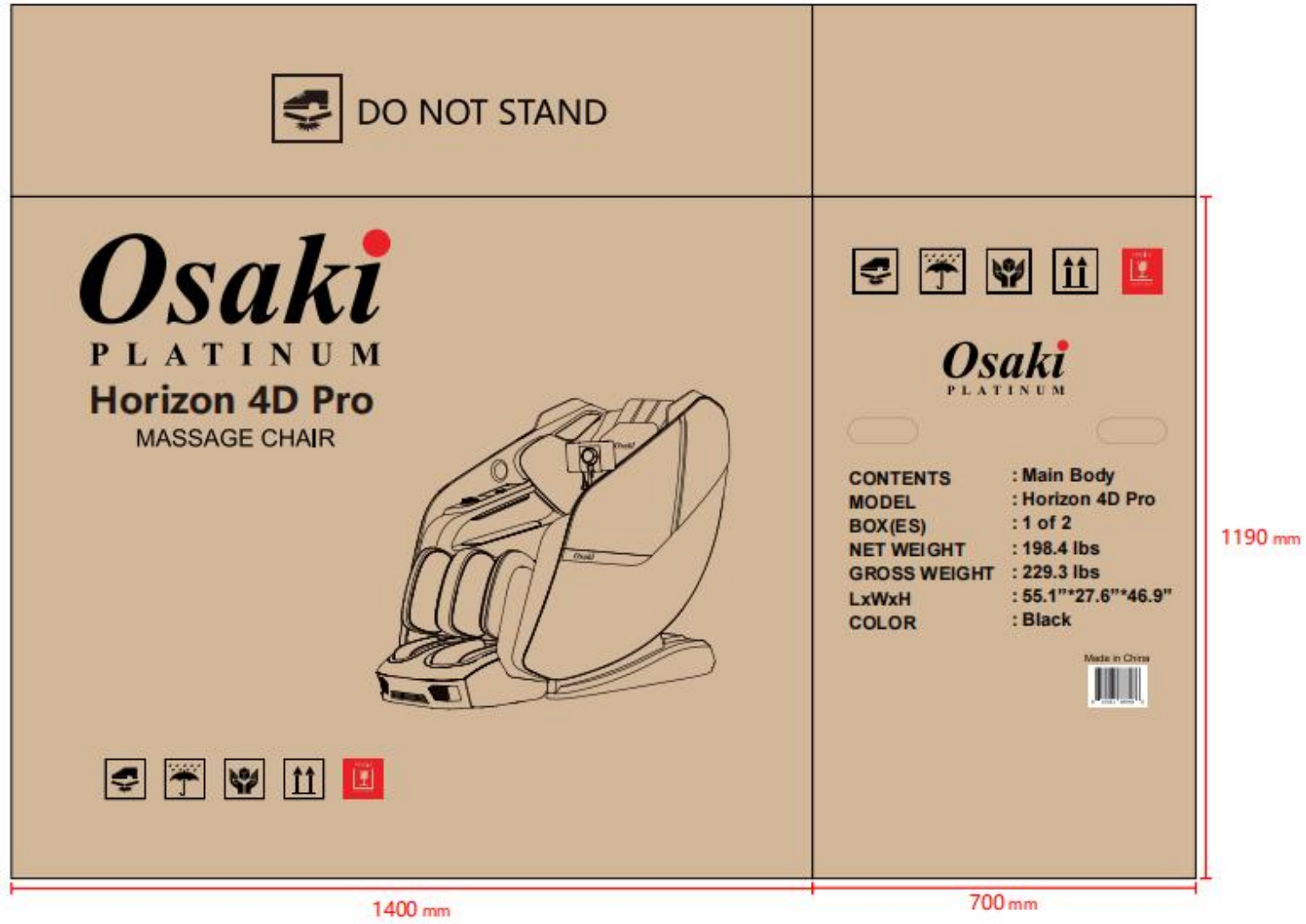

The diagram shows a brown cardboard box for the Osaki Platinum Horizon 4D Pro Massage Chair. The box is divided into two main sections. The top section contains a 'DO NOT STAND' warning icon and text. The bottom-left section features the Osaki logo, the product name 'Osaki PLATINUM Horizon 4D Pro MASSAGE CHAIR', and a line drawing of the chair. The bottom-right section contains handling icons, the Osaki logo, and a list of product specifications. A 'Made in China' label and a barcode are located at the bottom right of the box. Dimensions are indicated: 1400 mm for the main body width, 700 mm for the right-side width, and 1190 mm for the total height.

DO NOT STAND

Osaki
PLATINUM
Horizon 4D Pro
MASSAGE CHAIR

Osaki
PLATINUM

CONTENTS	: Main Body
MODEL	: Horizon 4D Pro
BOX(ES)	: 1 of 2
NET WEIGHT	: 198.4 lbs
GROSS WEIGHT	: 229.3 lbs
LxWxH	: 55.1"*27.6"*46.9"
COLOR	: Black

Made in China

1400 mm 700 mm 1190 mm

1. 4. 1 • Product size

Side panel
carton size



2. Structure of massage chair

1. Component name
2. Internal part drawing
3. Internal wiring diagram of power box

2.1.1 • Component name

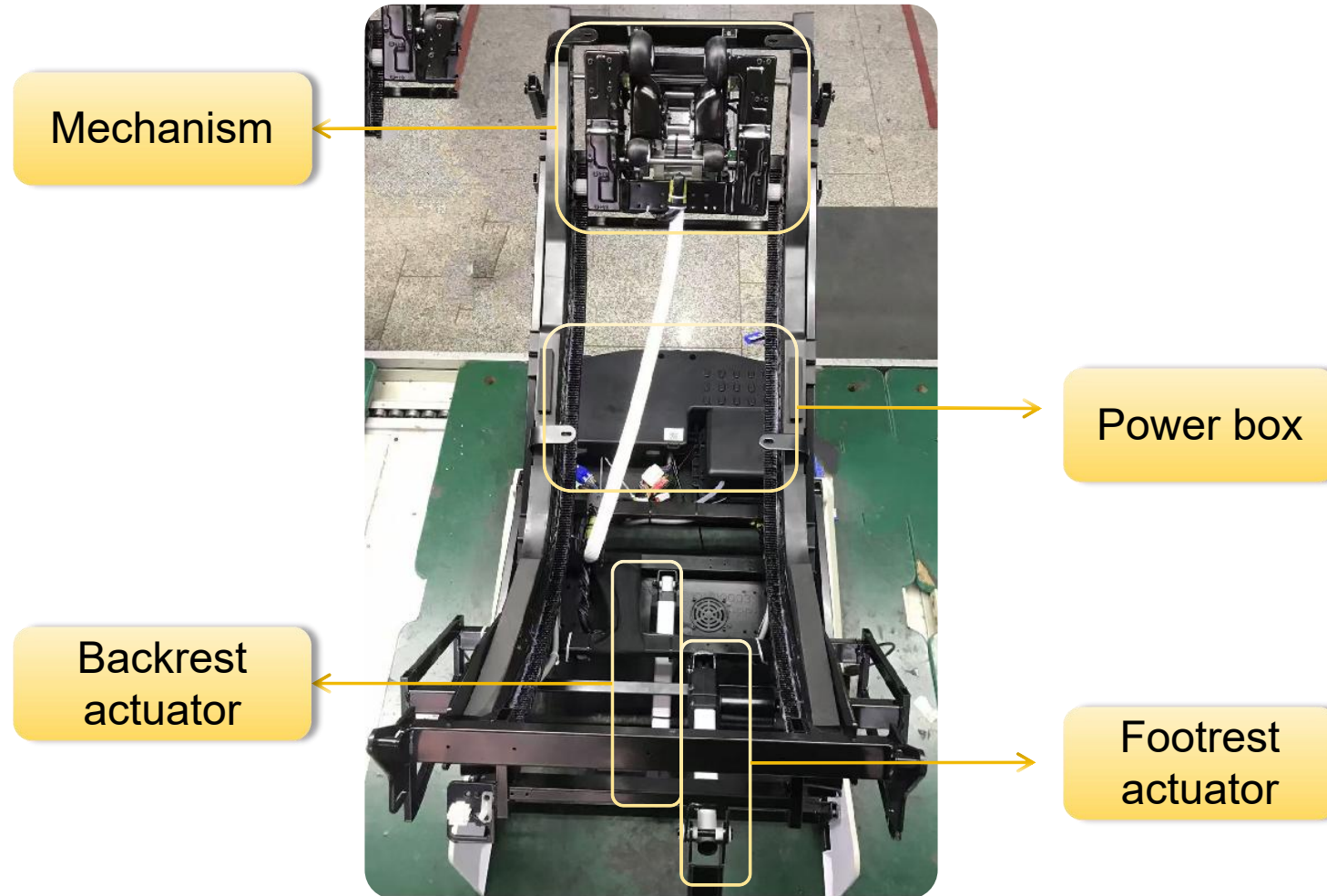

2.2.1 • Internal part drawing

Main PCB

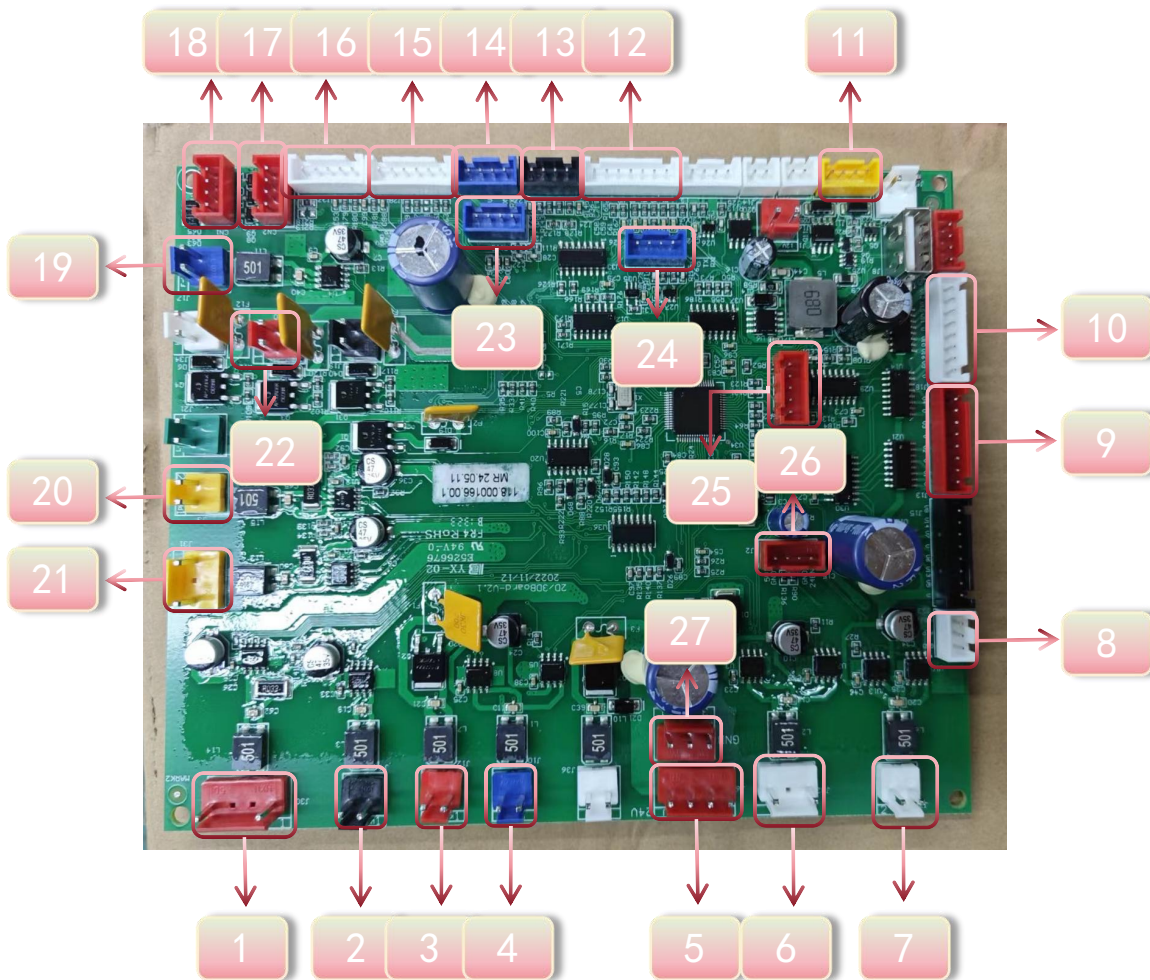

No.:	Port function	No.:	Port function	No.:	Port function
1	Footrest actuator	13	Upper & lower limits	25	Program download port
2	Mech walking motor	14	Voice Control	26	DC5V input
3	Mech knocking motor	15	Anti-pinch signal	27	Wireless charging
4	Mech kneading motor	16	3D Mech signal		
5	DC24V input	17	Light control		
6	DC24V Air pump	18	Light control		
7	3D mech motor	19	Leg lift motor		
8	120V Air pump control	20	Foot lift motor		
9	Left armrest air valve	21	Backrest actuator		
10	Right armrest air valve	22	Foot heating		
11	Negative ion fan	23	Shortcut key		
12	W M N shoulder signals of the mech,kneading,walking count, and foot signals	24	Bluetooth		

2. 2. 2 • Internal part drawing

Power board &
Bluetooth pcb

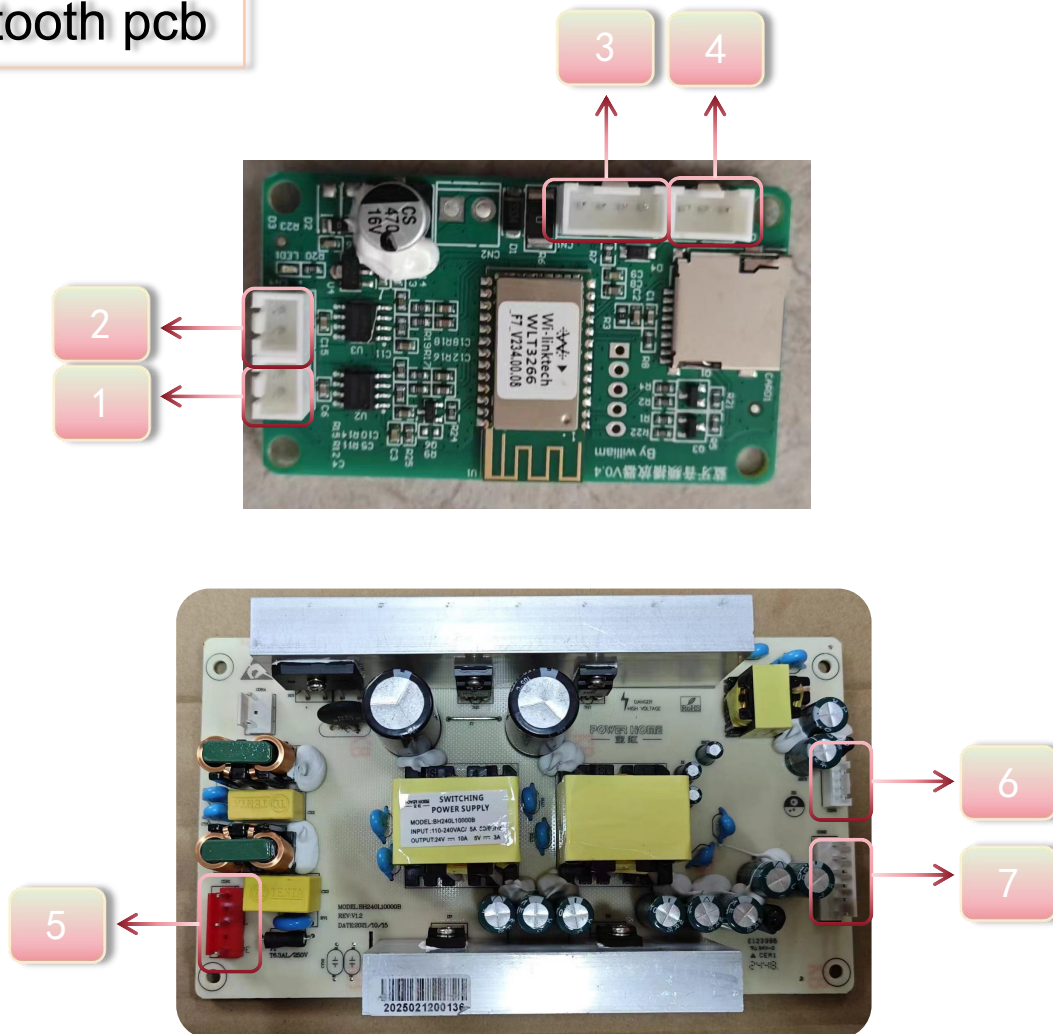

No.	Port function
1	Left audio signal output
2	Right audio signal output
3	Amplifier board control line
4	Sleep aid music line
5	AC120V input
6	DC5V output
7	DC24V output

2.3.1 • Internal wiring diagram of power box

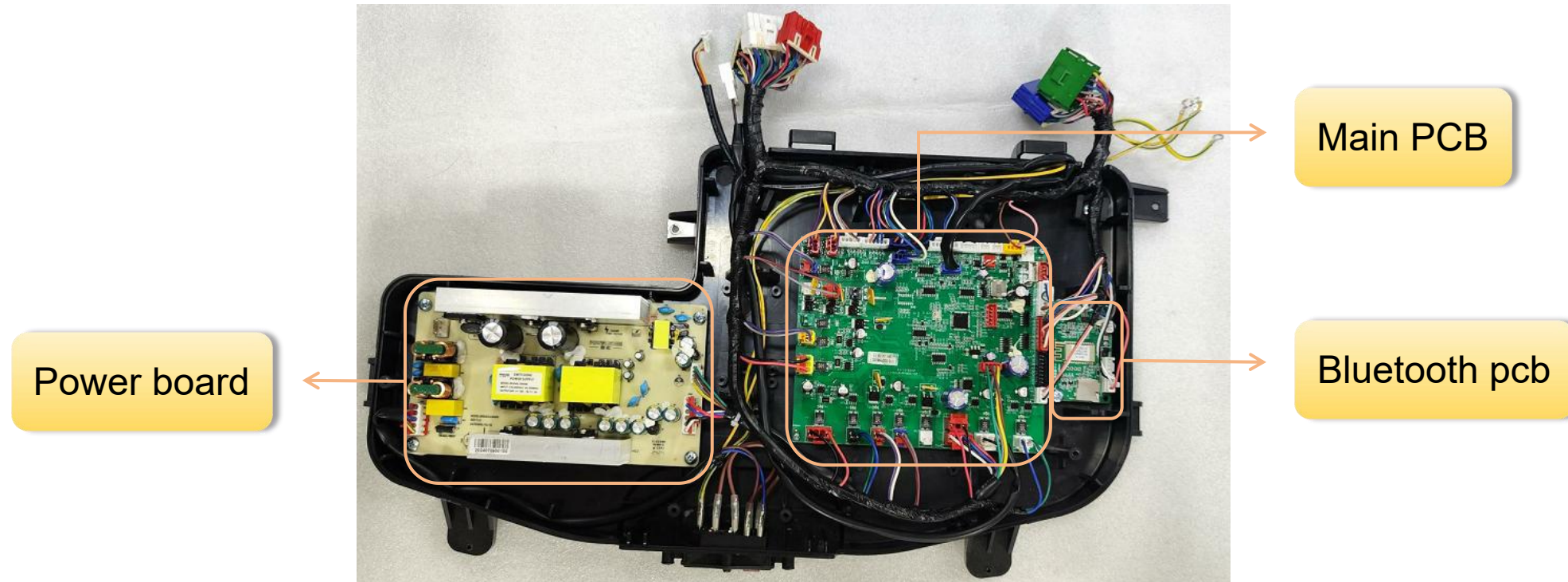

3. Disassembly diagram of the massage chair

1. Disassemble the cushion

2. Disassemble the footrest

3. Disassemble the back cover

4. Disassemble the armrest

5. Disassemble the backrest

6. Disassemble the mechanism

7. Disassemble the power box

8. Disassemble the side panel

9. Disassemble the actuator

3. 1. 1 • Disassemble the cushion

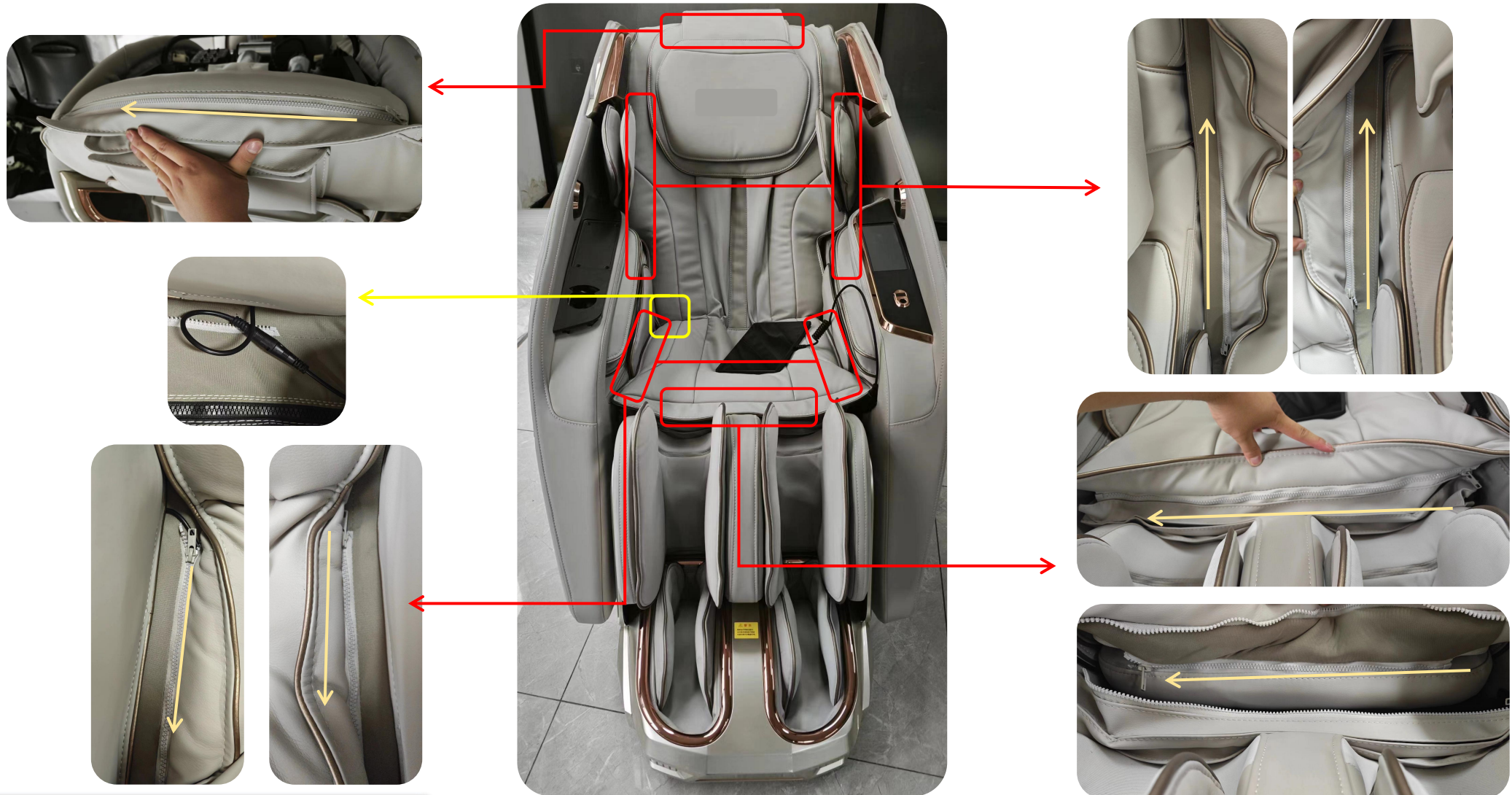

① Pull the zippers at the position

② Remove the heating terminal

3. 1. 1 • Disassemble the cushion



③ Cushion type

3. 2. 1 • Disassemble the footrest

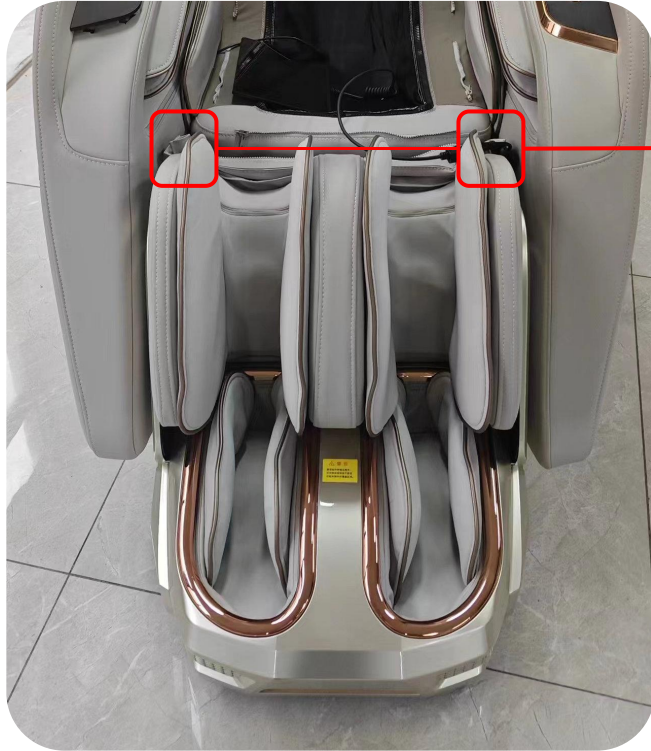

① Disassemble 2pcs clamps in the picture, Remove the components by dislocation

Clamp type



② Remove the air pipe and the terminal

Footrest assy

3. 2. 2 • Disassemble the footrest



Disassemble the footrest



① Remove 12 pcs fixing screws



Back cover of the footrest

Screws type

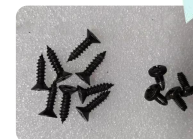

3. 2. 2 • Disassemble the footrest



② Remove the outer covers of both side panels

③ Remove the screws at the bottom of the side panel, bend it outward & take off the side panel

The front of the left panel

Screw type

The back of the left panel

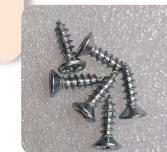

Note: same way of the left and right side panel

3. 2. 2 • Disassemble the footrest

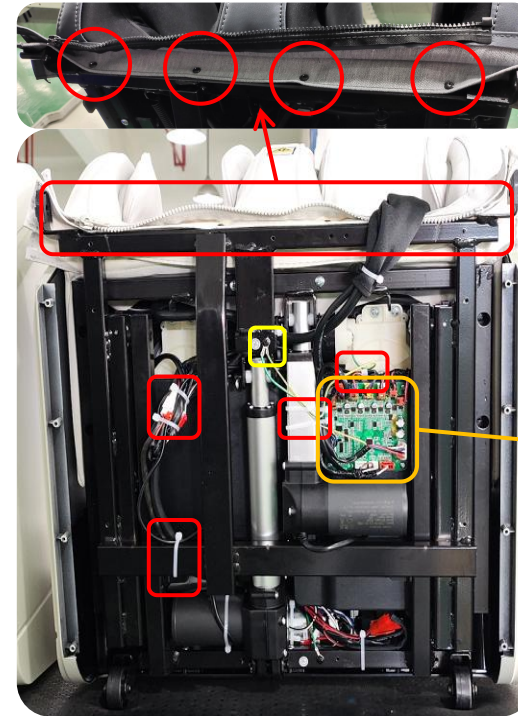
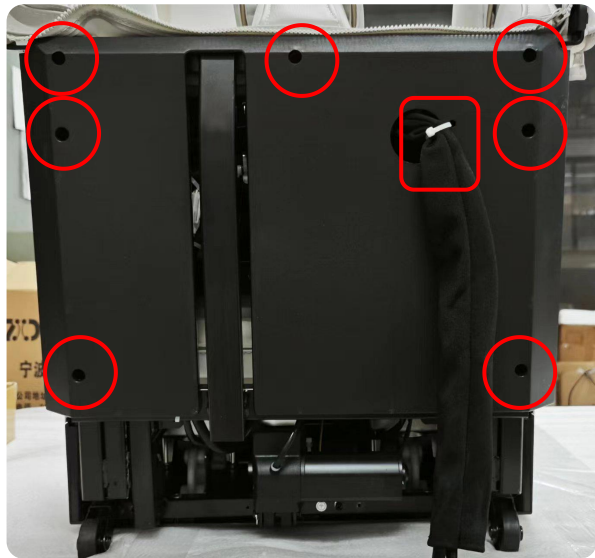

④ Remove the screws & cut off the cable ties

Screw type



Leg back cover

⑤ Remove the screws in the picture & cut off the cable ties

⑥ Remove air pipes & terminals, and remove the terminals on the calf plate

3. 2. 2 • Disassemble the footrest



Footrest harness



⑦ Remove the fixed pin

Pin type

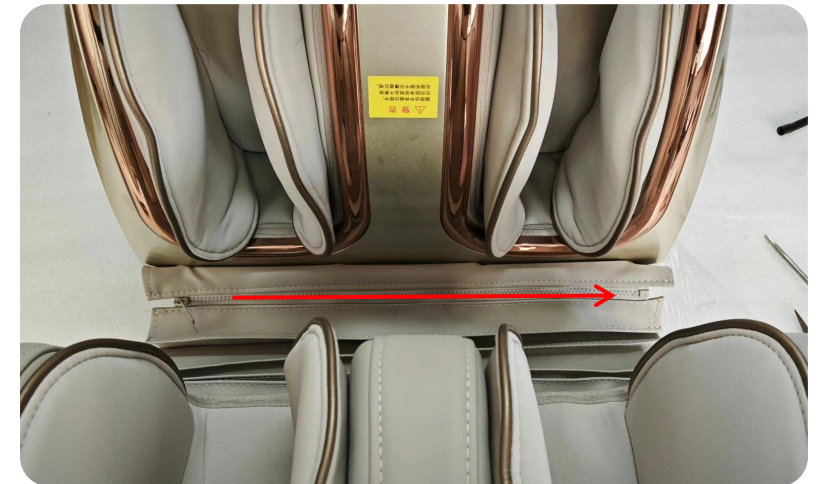

⑧ Flatten the footrest and unzip the zipper

3. 2. 2 • Disassemble the footrest



⑨ Lift the
footrest upwards



Leg assy



Foot assy



Leg welding
parts

3. 2. 2 • Disassemble the footrest

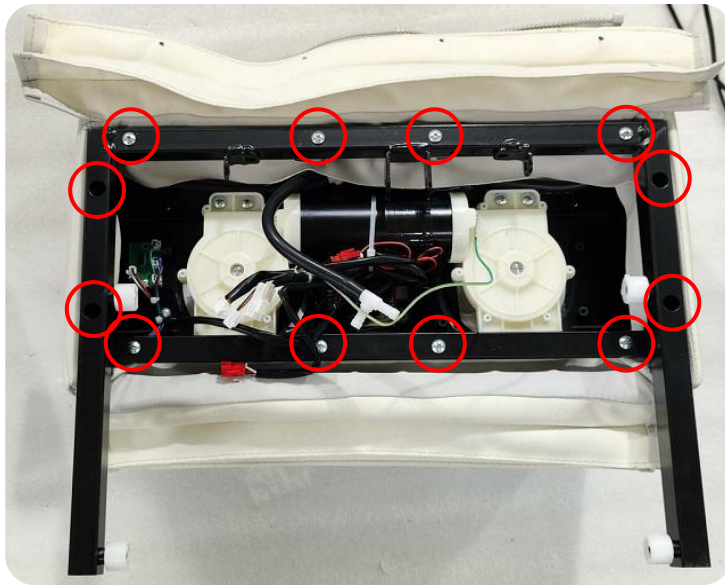

⑩ Remove the screws



the welded parts

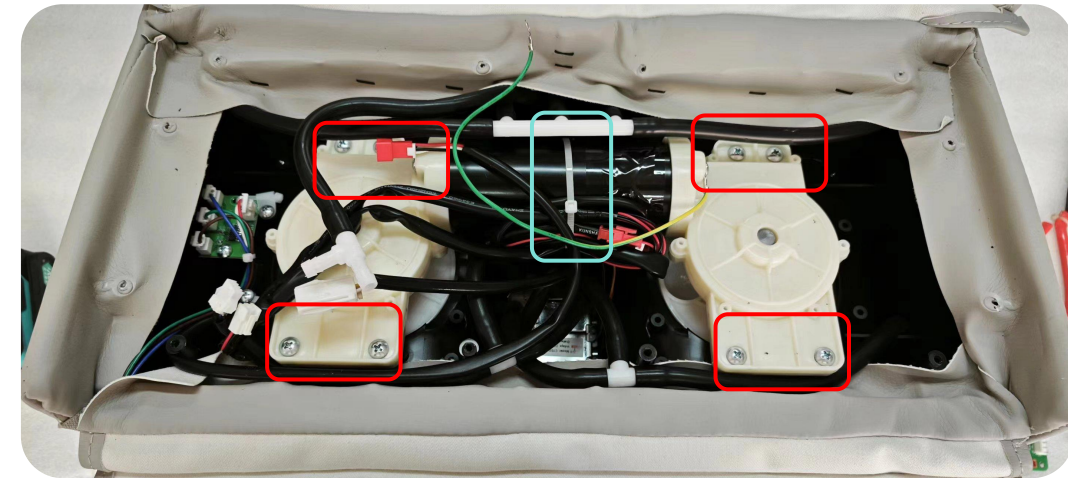

⑪ Remove the screws & cut off the cable ties

Screw type



3. 2. 2 • Disassemble the footrest

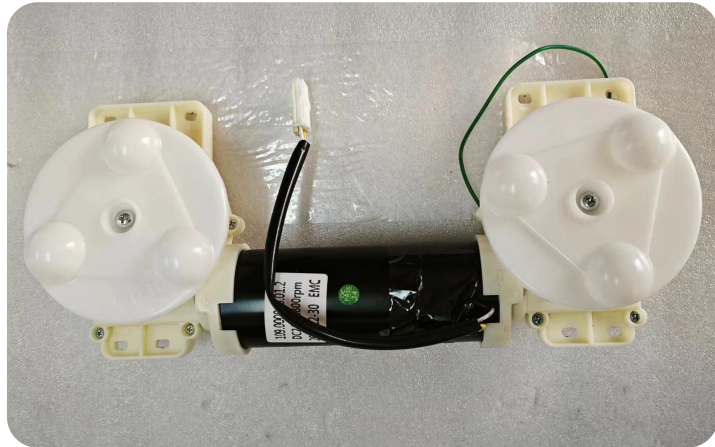

Leg roller dish assy

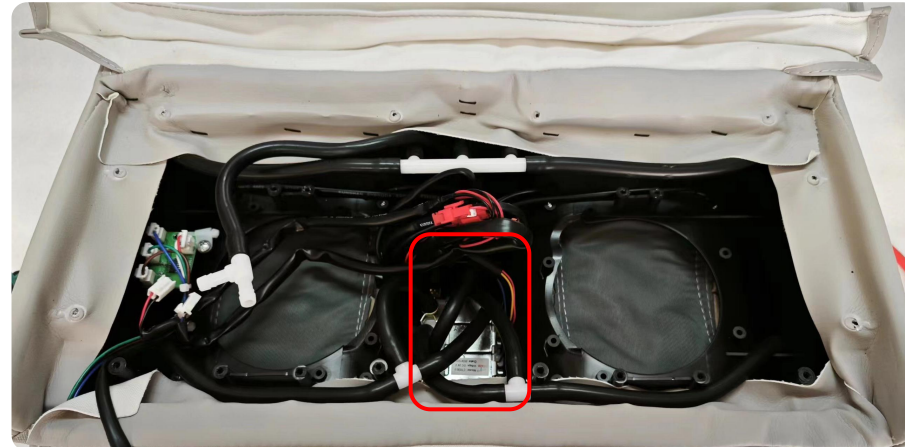

⑫ Remove the screws and take off the air valve

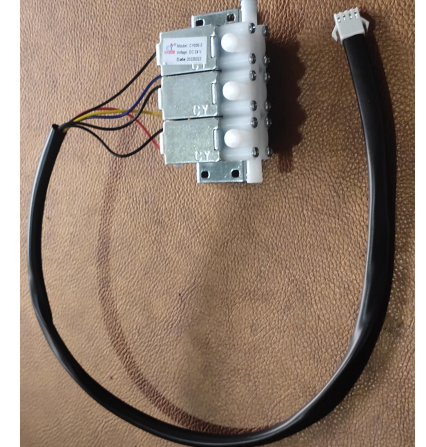

Air valve assy

3. 2. 2 • Disassemble the footrest

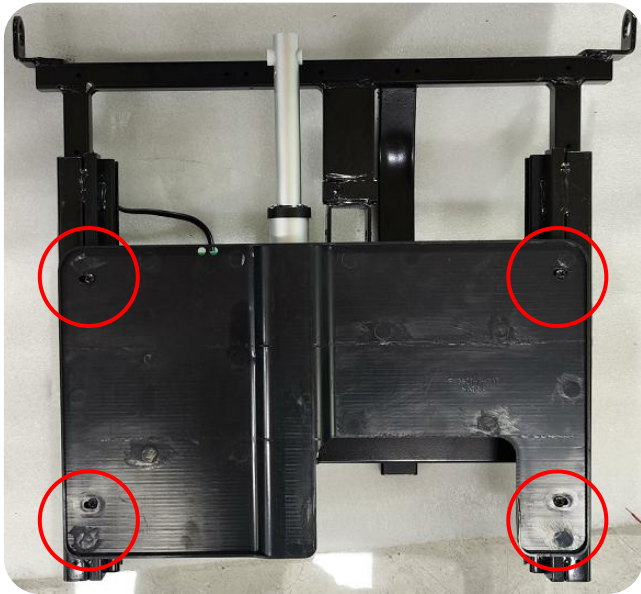

13 Remove the screws



14 Remove the screws



Leg baffle

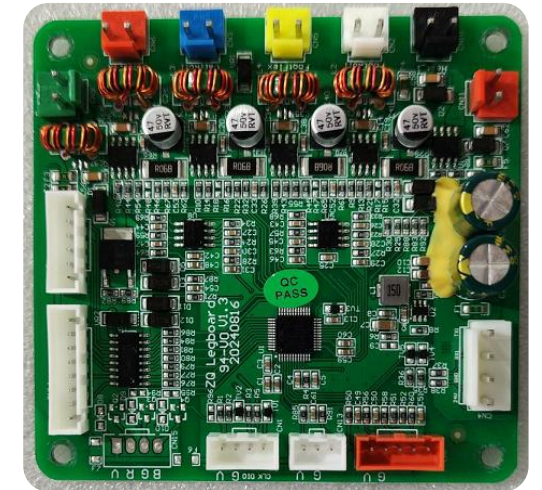

Footrest PCB

3. 2. 2 • Disassemble the footrest

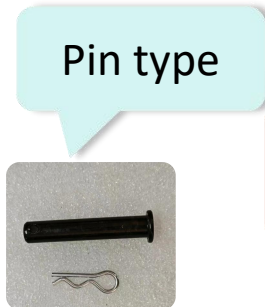

⑮ Remove the fixed pin



Legrest actuator

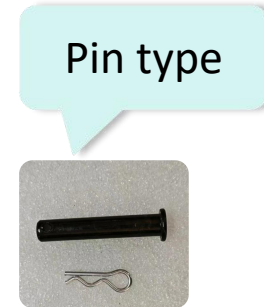

⑯ Remove the fixed pin



Footrest actuator

3. 2. 2 • Disassemble the footrest



17 Remove the screws that fix the ground wire

3. 2. 2 • Disassemble the footrest



⑲ Disassemble the foot front cover assy

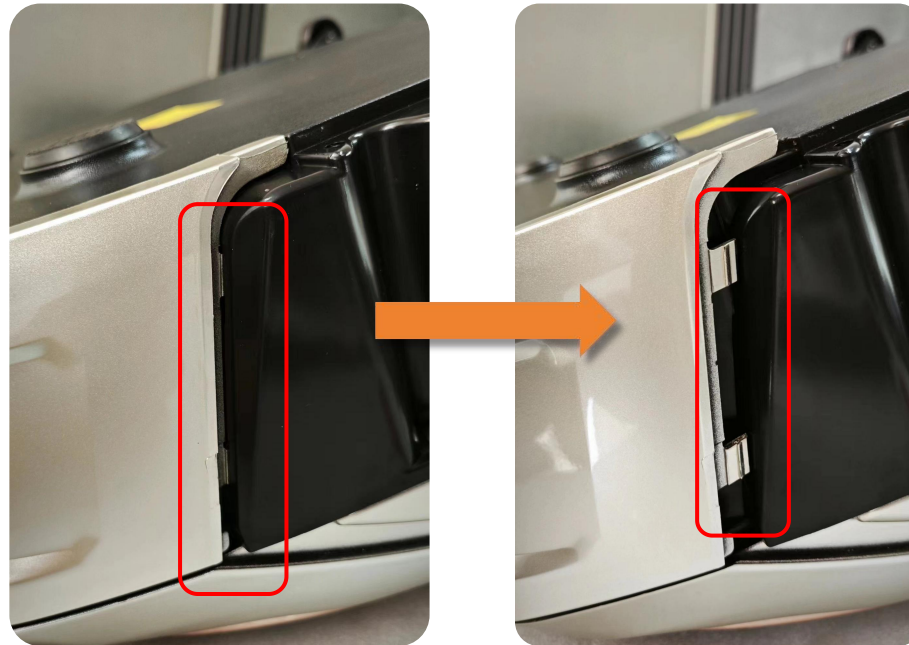

⑳ Pry open the side decorative part and bend it outward with force



Foot front cover assy

3. 2. 2 • Disassemble the footrest



②1 Remove the screws

Screw type



Toe cover decorative part

Foot front cover

3. 2. 2 • Disassemble the footrest

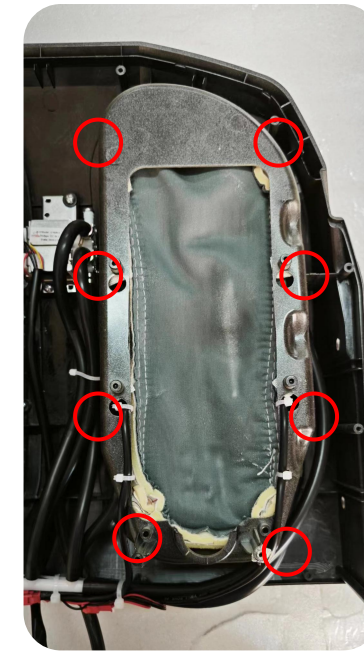

②② Remove the screws

Screw type



②③ Remove the foot trim

Screw type



②④ Remove the screws

the foot trim

3. 2. 2 • Disassemble the footrest

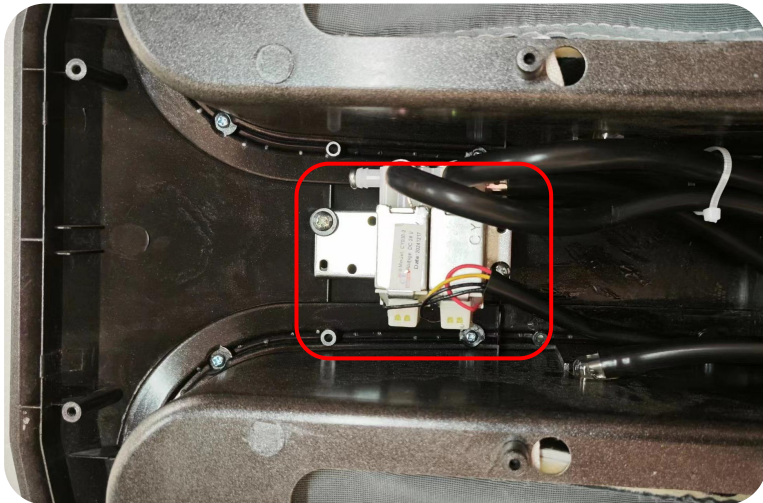

Foot air valve

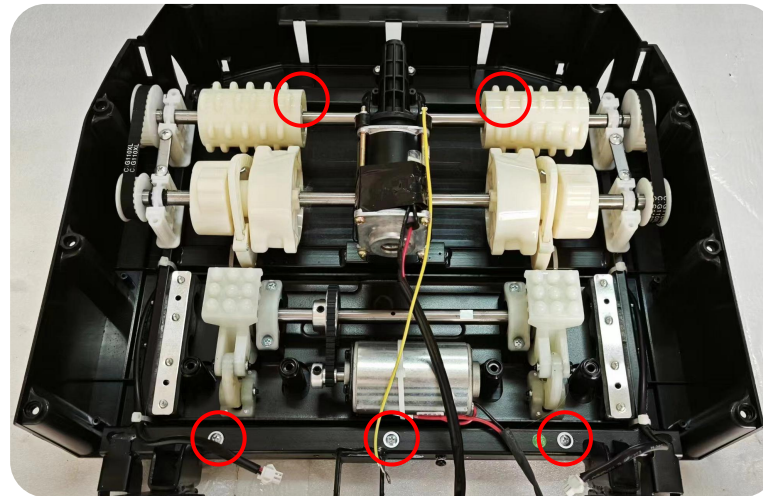

25 Remove the screws

Screw type



Foot lower cover

3. 2. 2 • Disassemble the footrest

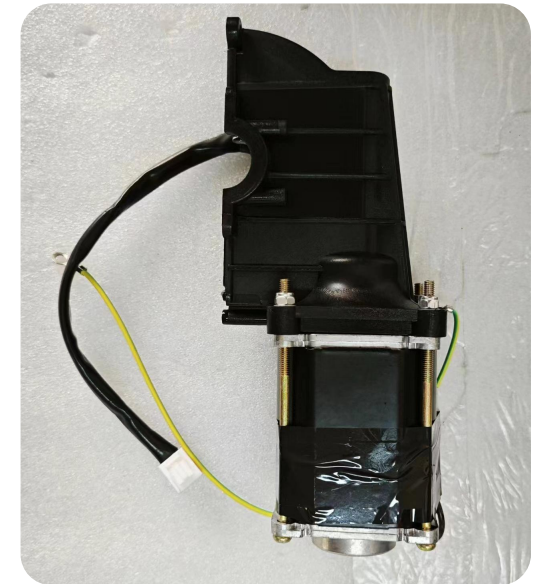
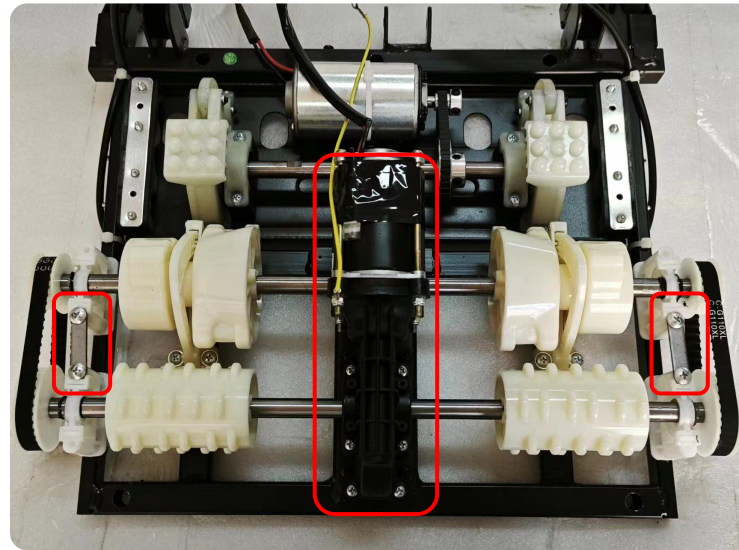
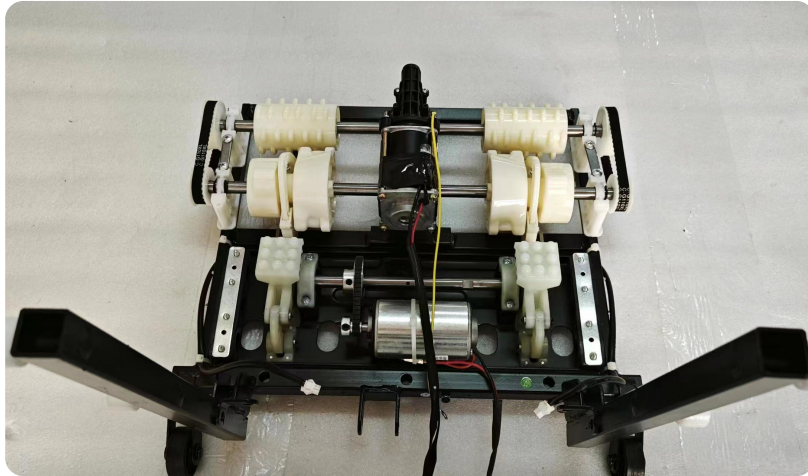

① Disassemble the roller assy

② Remove the screws

Screw type



Foot roller motor

3. 2. 2 • Disassemble the footrest

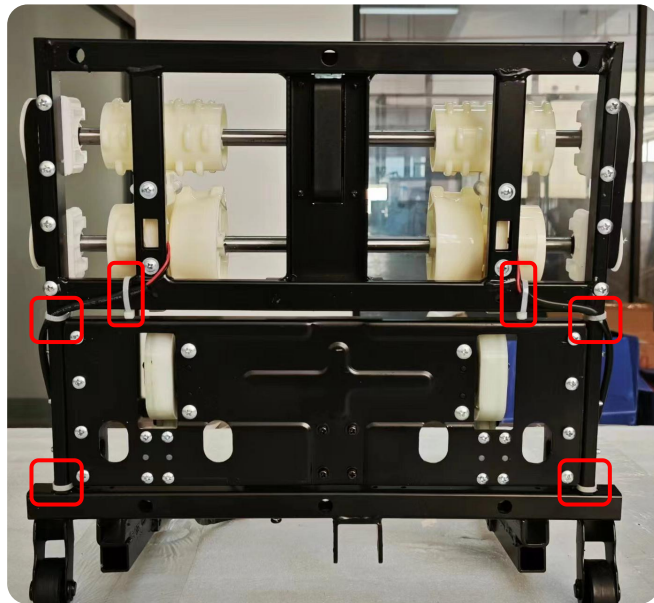

③ Cut off the fixing cable ties

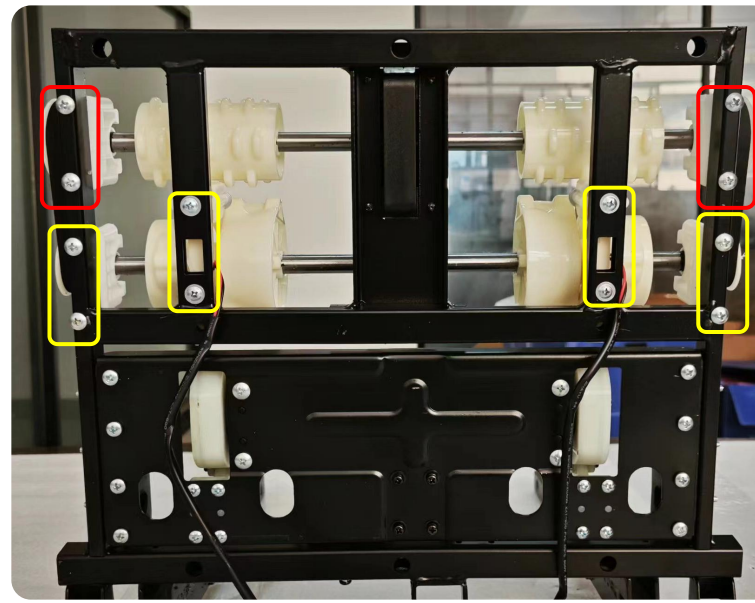

④ Remove the screws

Screw type



Double-row roller

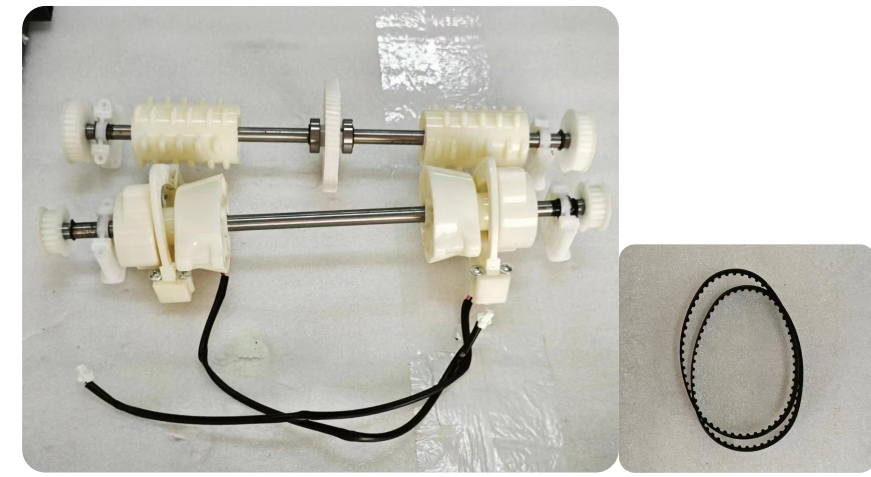

Belt

3. 2. 2 • Disassemble the footrest

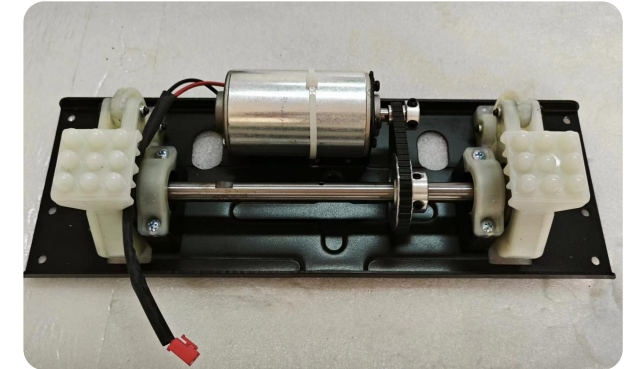
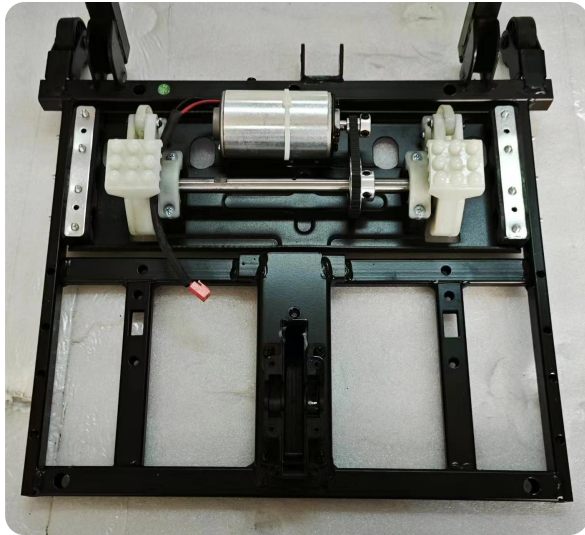

⑤ Remove the leg shaking mechanism assy

⑥ Remove the screws

Screw type



Leg shaking mechanism assy

3. 2. 2 • Disassemble the footrest

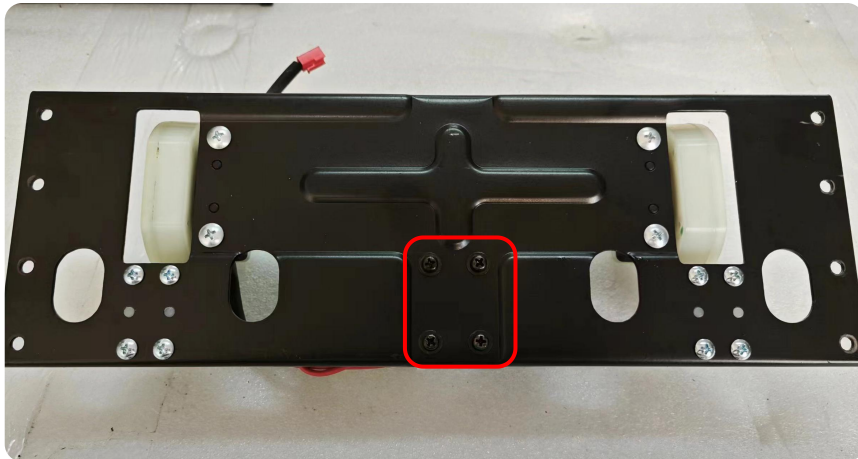

⑦ Remove the screws

Screw type



Motor

3. 2. 2 • Disassemble the footrest

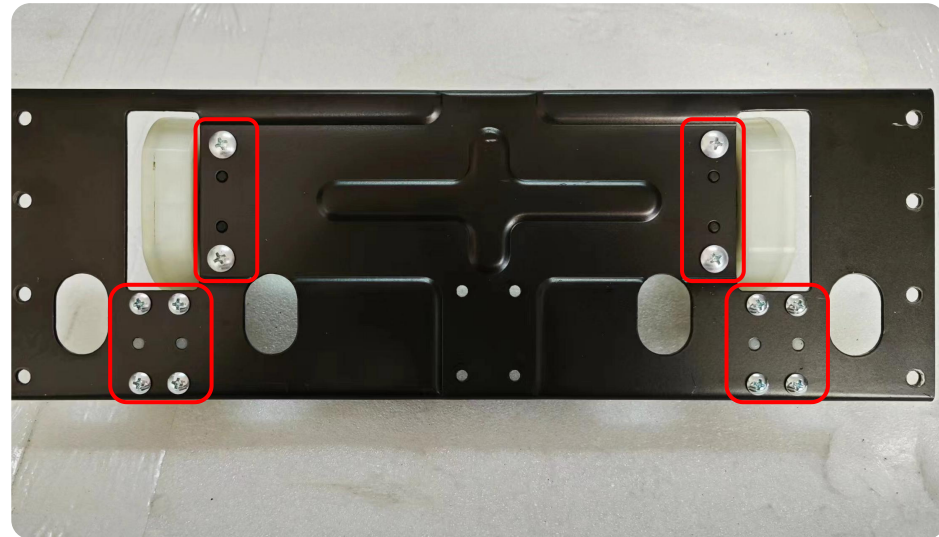

Metal sheet

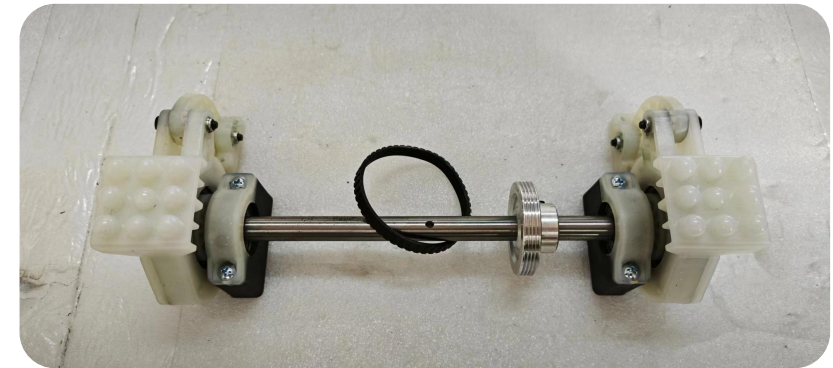

Leg shaking mechanism

⑧ Remove the screws

Screw type



3. 3. 1 • Disassemble the back cover



Screw
type

① Remove 2pcs
screws as picture



② Back cover

3. 4. 1 • Disassemble the armrest

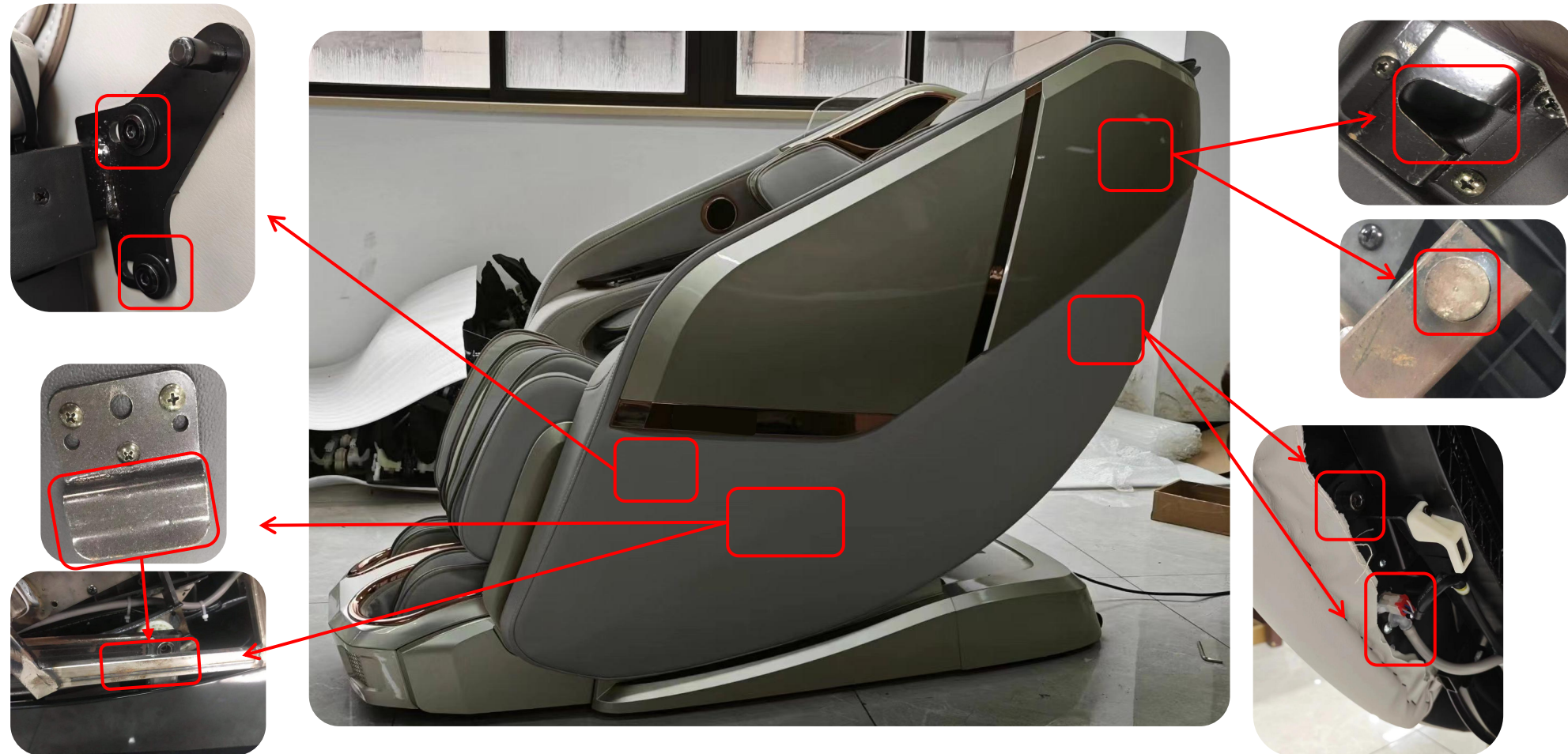

① Remove the screws that fix the front and back of the armrest

② Remove the air pipe and the terminal

Note: Same as left and right armrest

3. 4. 1 • Disassemble the armrest



③ The armrest

3. 4. 2 • Disassemble the armrest

Disassembly of the left armrest shoulder adjustment assy



① Remove the adjustable shoulder assy

② Pull out the air pipe & remove the screws

Screw type



Left shoulder sheet metal assy

3. 4. 2 • Disassemble the armrest

Disassembly of the left
armrest shoulder
adjustment assy

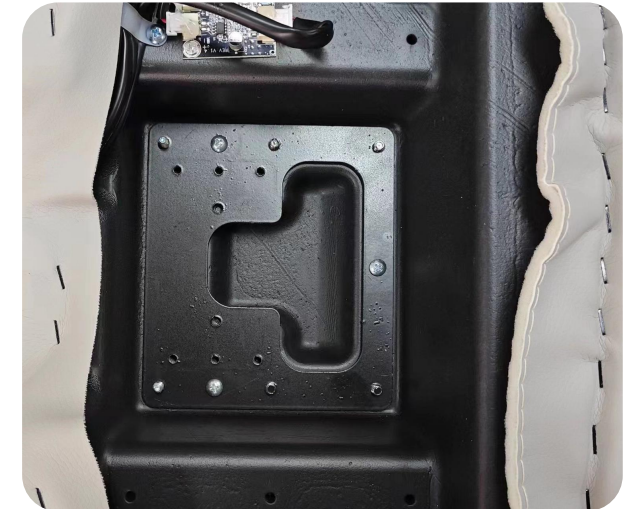
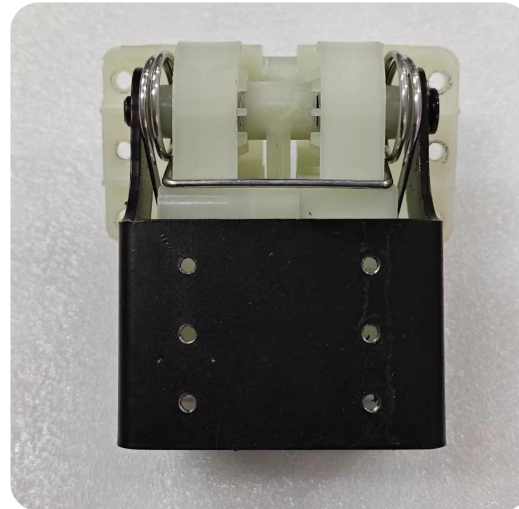
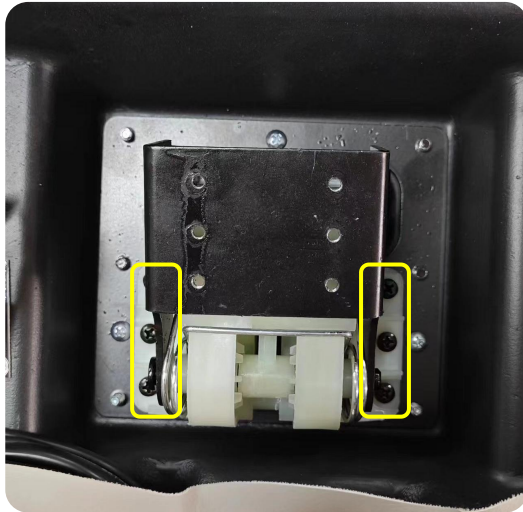

③ Remove
the screws

Screw
type



Left shoulder
adjuster assy

Note: Same as the left
and right armrest

3. 4. 3 • Disassemble the armrest

Disassembly of the decorative part on the left armrest



① Remove the armrest decorative part



② Remove the speaker decorative parts

3. 4. 3 • Disassemble the armrest

Disassembly of the decorative part on the left armrest



③ Remove the speaker cover on the left head

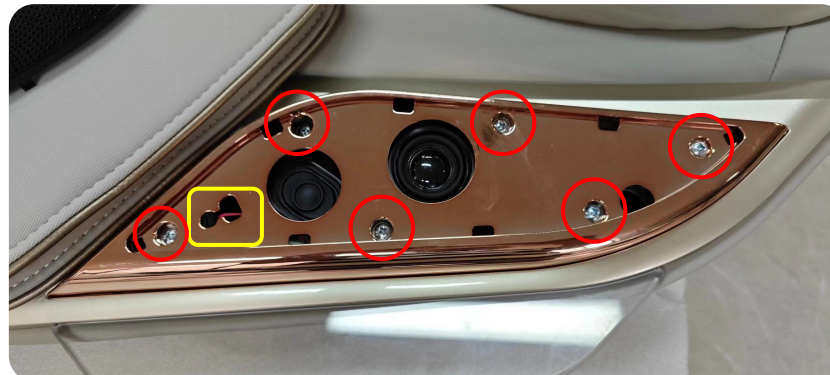

④ Remove the microphone and take off the screws

Screw type

⑤ Remove the left speaker seat



Speaker cover on the left head



Speaker seat on the left head

3. 4. 3 • Disassemble the armrest

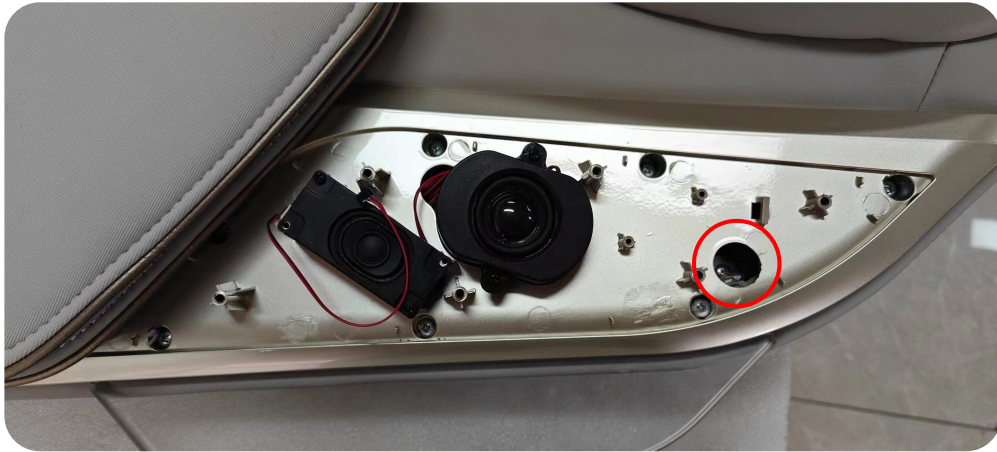

⑥ Remove the
fixing screws

3. 4. 3 • Disassemble the armrest

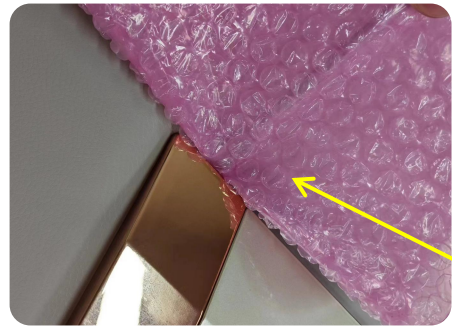

The front decorative part on the left armrest



⑦ Use a tool to pry open the decorative part

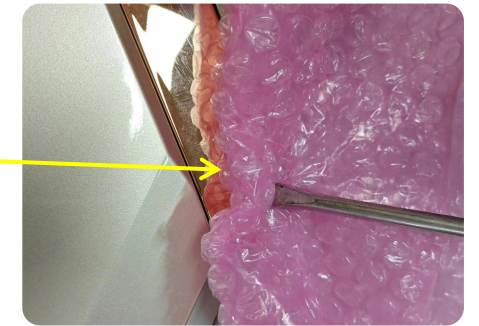

The middle decorative part on the left armrest

3. 4. 3 • Disassemble the armrest



⑧ Remove the screws and cut off the fixing cable ties

Screw type



⑨ Remove the terminals of the light strip

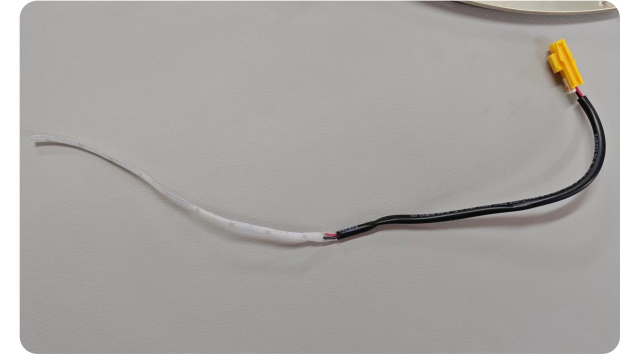

Light strip



Left panel decorative part

3. 4. 4 • Disassemble the armrest

Disassembly of the speaker on the left armrest



⑩ Remove 1pcs fixing screw

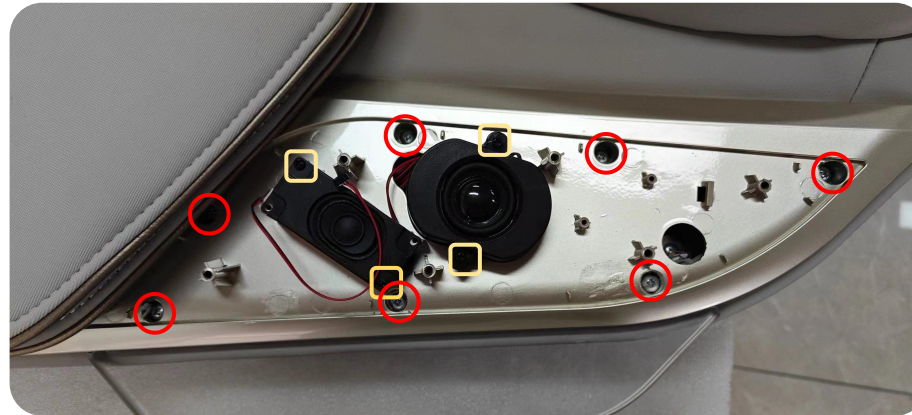

⑪ Remove 7pcs screws and then remove 4 more



Left head decorative part



Speaker

Note: Remove the decorative parts and screws, pull out the terminals, and take off the speaker

3. 4. 5 • Disassemble the armrest

Disassembly of the acrylic light panel on the left armrest



⑫ Remove 4pcs screws

Screw type



⑬ Remove the acrylic light panel and cut off the cable ties



Acrylic light panel



LED light strip

3. 4. 6 • Disassemble the armrest

Disassembly of
the speaker on
the left armrest

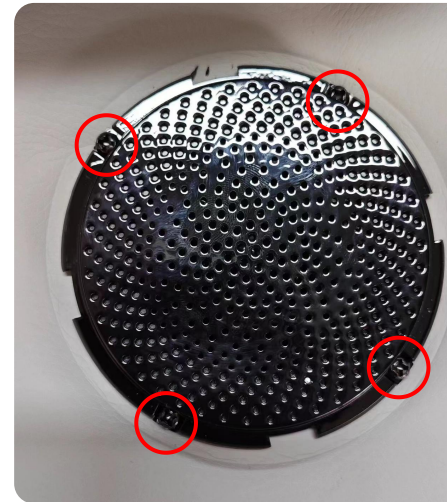
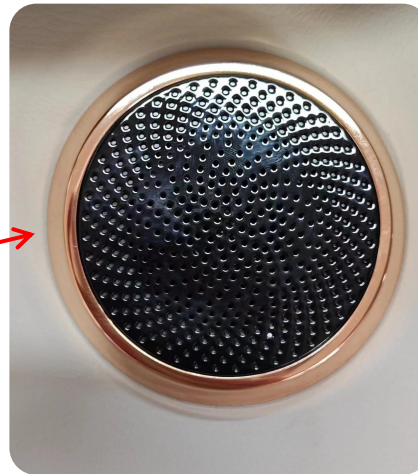

Speaker seat



Speaker net cover

① Rotate the speaker
seat anticlockwise to
remove it

② Remove
4pcs screws

3. 4. 6 • Disassemble the armrest

**Disassembly of
the speaker on
the left armrest**



Speaker

3.5.1 • Disassembly of the backrest



① Disassemble the backrest assy

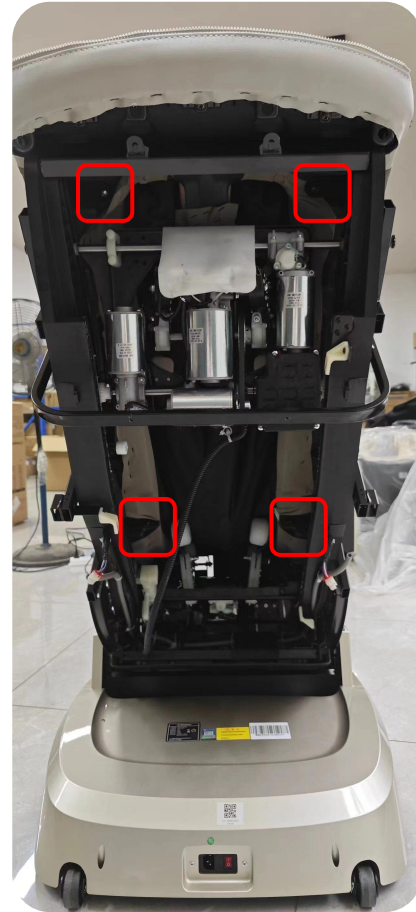

② Remove 4pcs screws in the picture



② Remove 2pcs screws

Screw type

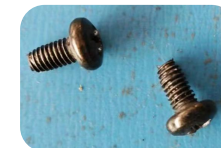

Backrest assy

3. 6. 1 • Disassembly of the mechanism

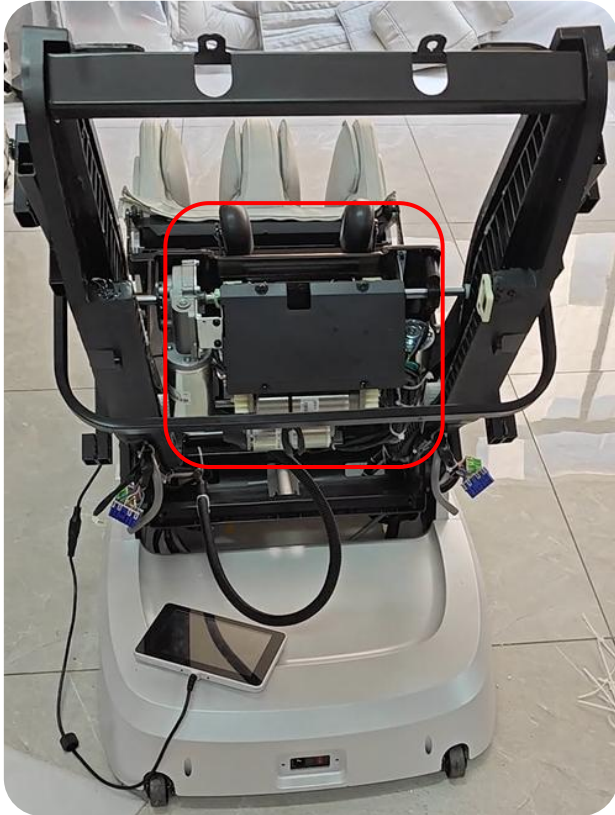

① Disassemble the mech

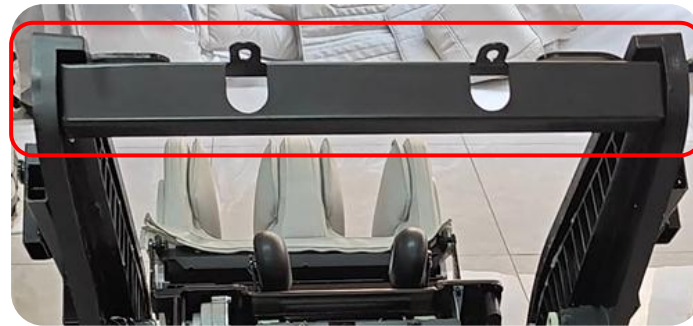

② Disassemble the iron frame bar



③ Remove the screws in the picture (2pcs on each side)



3. 6. 1 • Disassembly of the mechanism



④ Remove the induction magnet



⑤ Connect the power cord and turn on the tablet

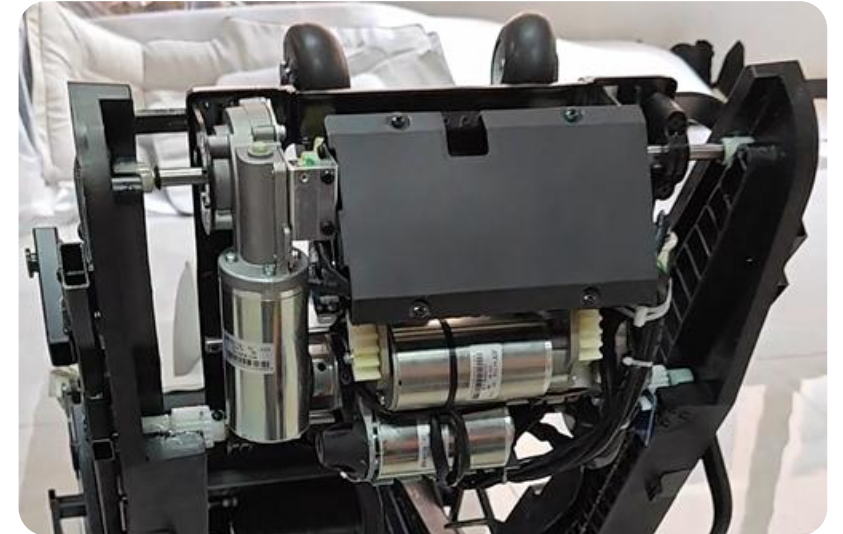

⑥ Operate the tablet to push the mech to the top

3. 6. 1 • Disassembly of the mechanism

Mechanism operating steps

1. Turn on the mech.
2. Click on the "custom" massage.
3. Click on the "kneading" function.
4. Click on the "fixed point"
5. mech position adjustment, long press "upward"
6. the movement can be suspended summit.

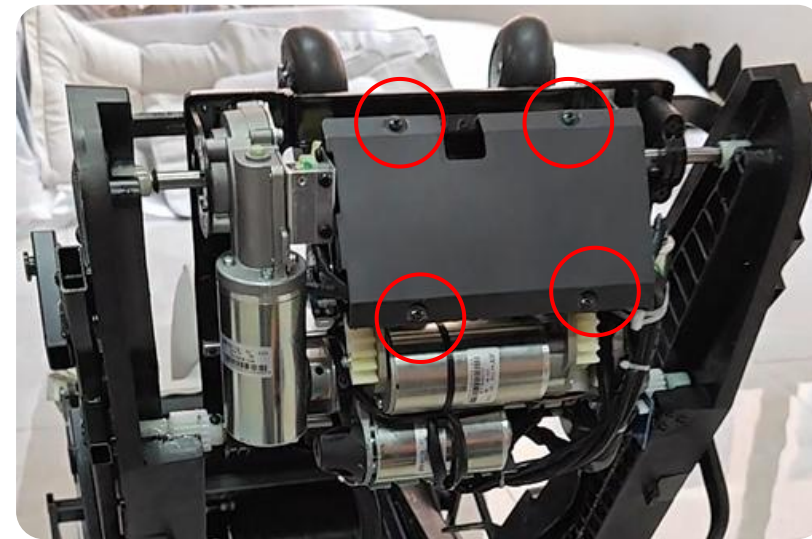

7 Remove 4pcs screws and take off the mech cover plate

3. 6. 1 • Disassembly of the mechanism

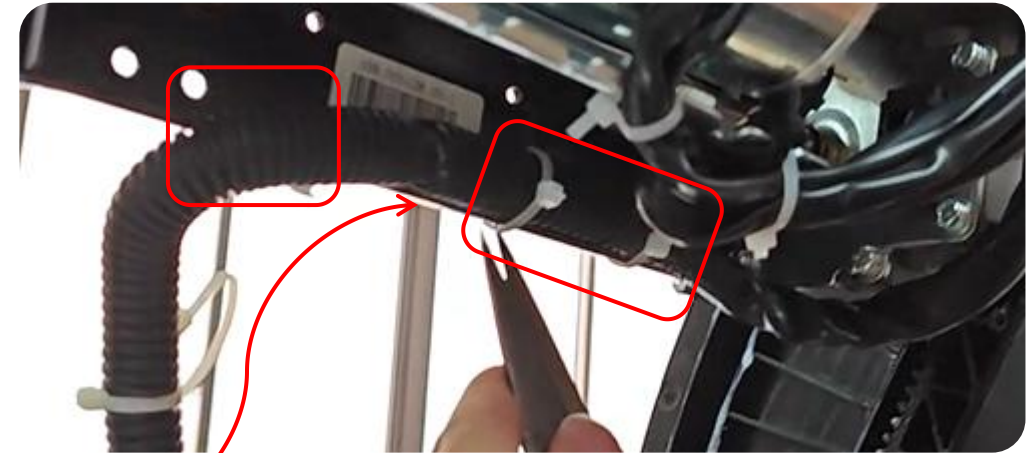
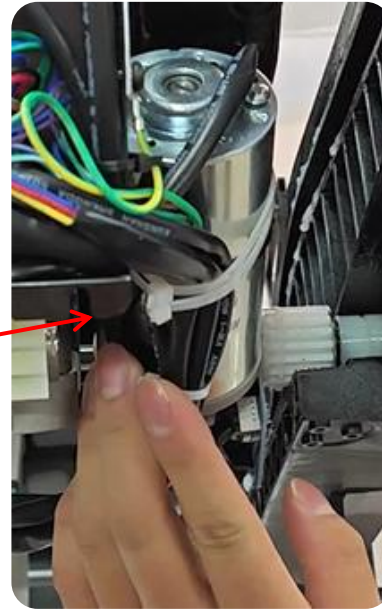
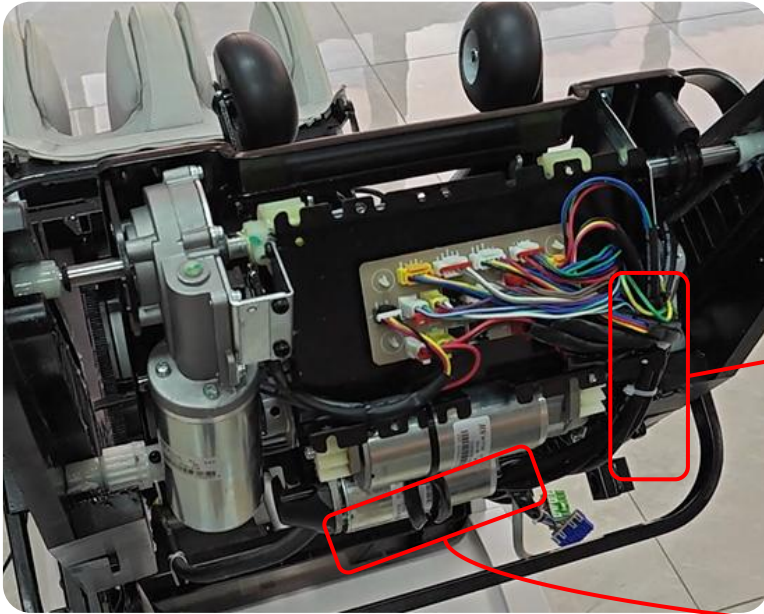

⑧ Remove the cable ties that fix the mech harness

3. 6. 1 • Disassembly of the mechanism



⑨ Remove the screws that fix the ground wire

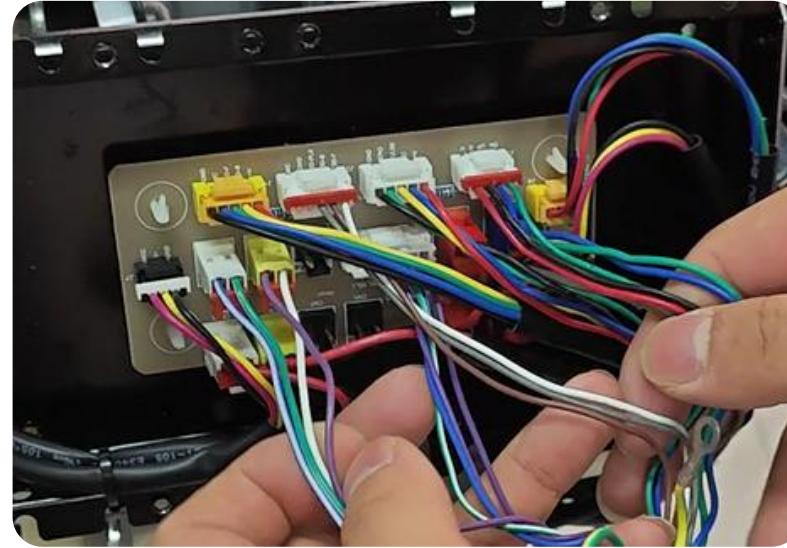

⑩ Remove the terminals to the mech harness

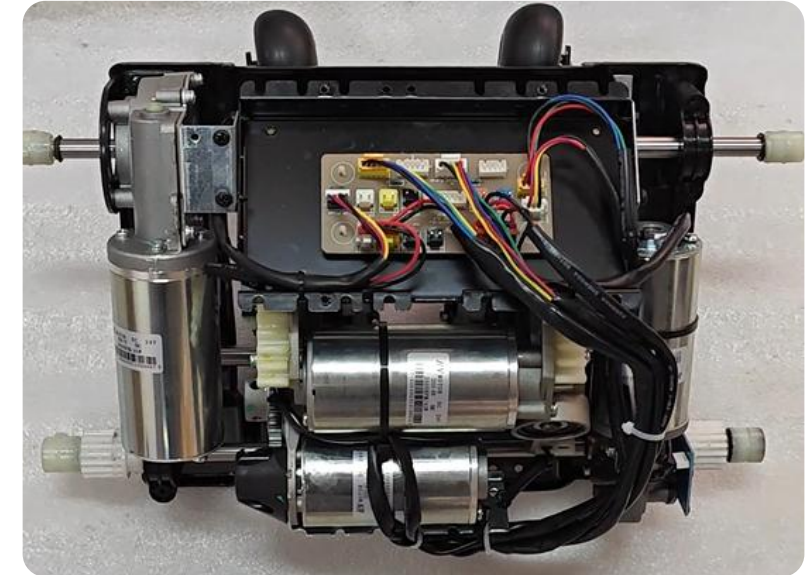

The mechanism

3. 7. 1 • Disassembly of the power box



Screw
type

① Remove 4 pcs
screws in the picture



Screw
type

② Remove 4 pcs
screws in the picture



The outer cover
of the power box



The
upper
cover

3.7.1 • Disassembly of the power box

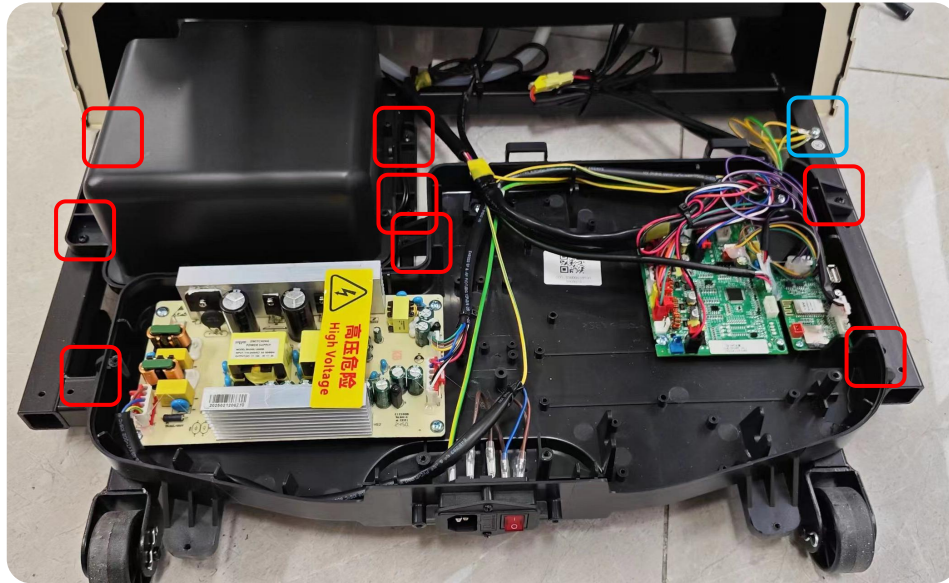

① Remove 4pcs screws in the picture and take off the ground wire screw.

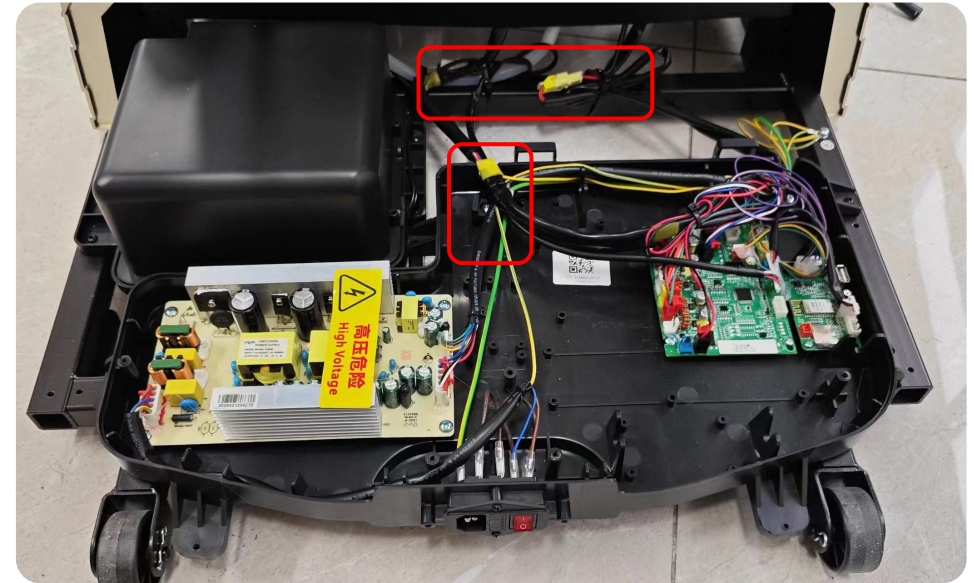

② Unplug the connection harness

3. 7. 1 • Disassembly of the power box

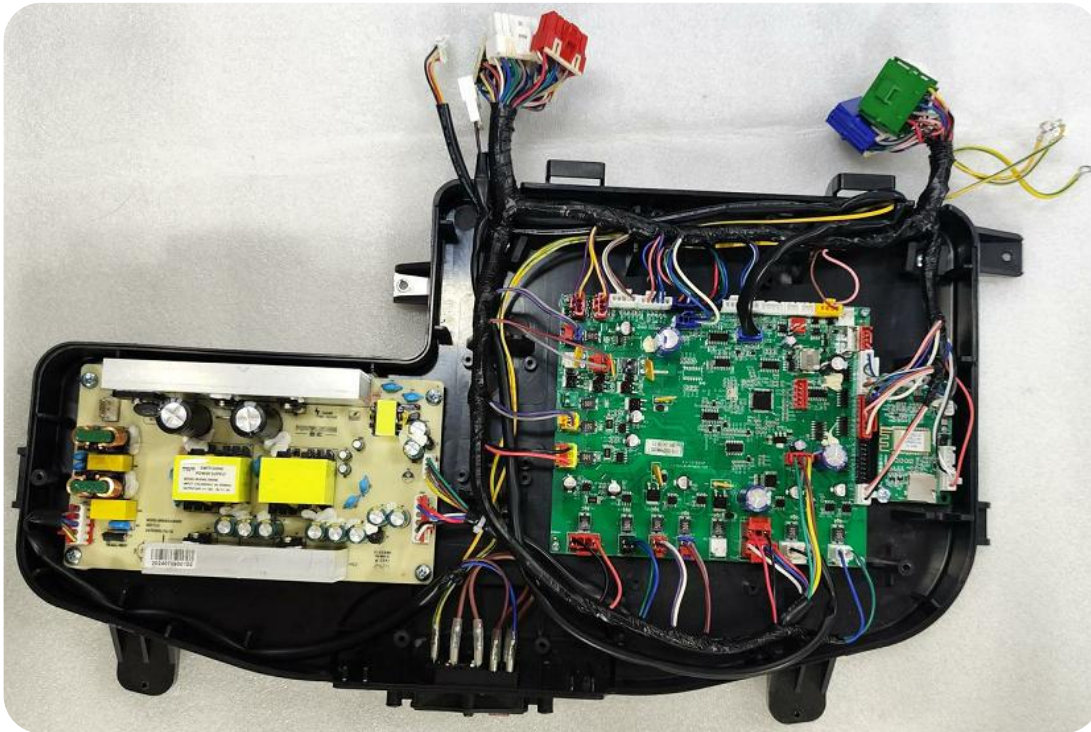

Power box assy



Air pump assy

3. 8. 1 • Disassembly of the side panel

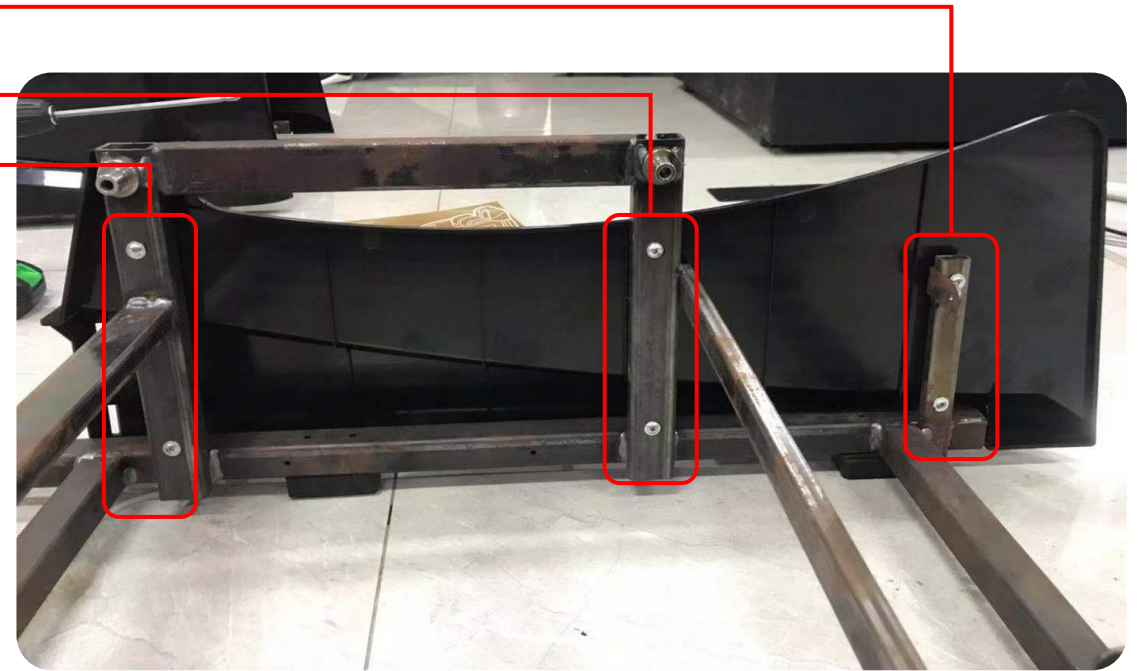
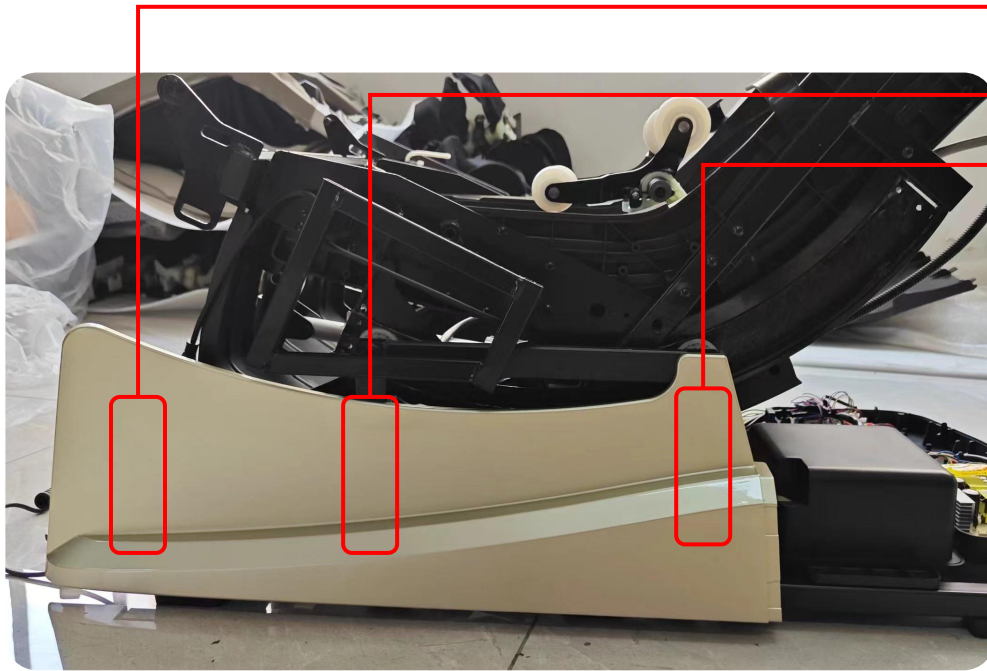

① Remove 6pcs fixing screws

Screw type



3. 8. 1 • Disassembly of the side panel



Left lower side
panel assy

Note:same as the left and right one

3.9.1 • Disassembly of the actuator

Disassemble the footrest actuator

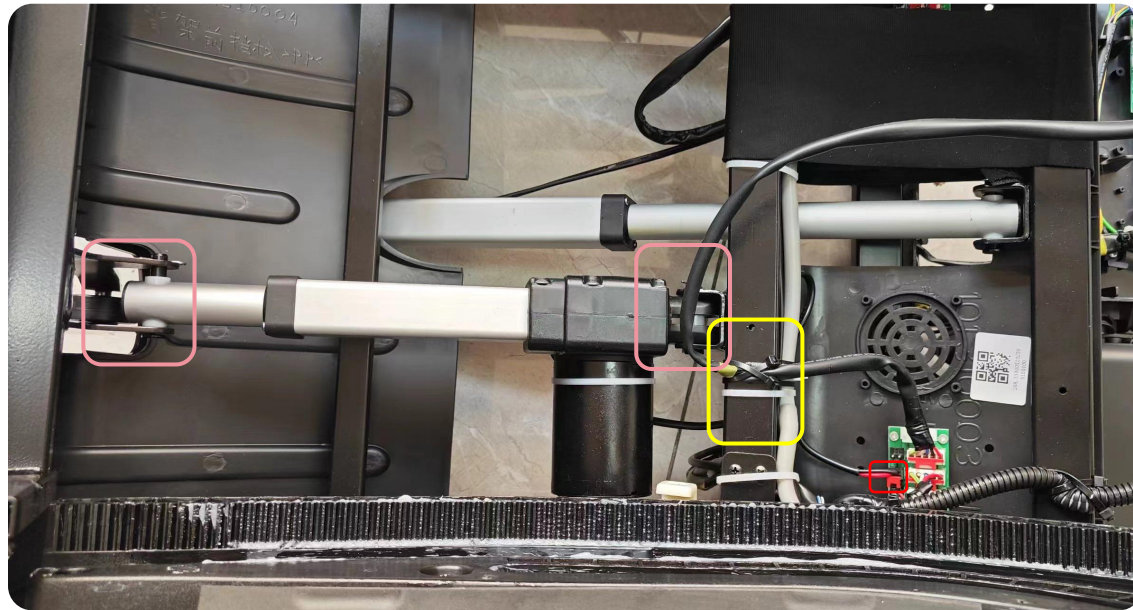

① Remove the fixed pins at both ends

② Cut off the cable ties of the harness

③ Remove the terminal of the actuator

The footrest actuator

3.9.1 • Disassembly of the actuator

Disassembly of the backrest actuator

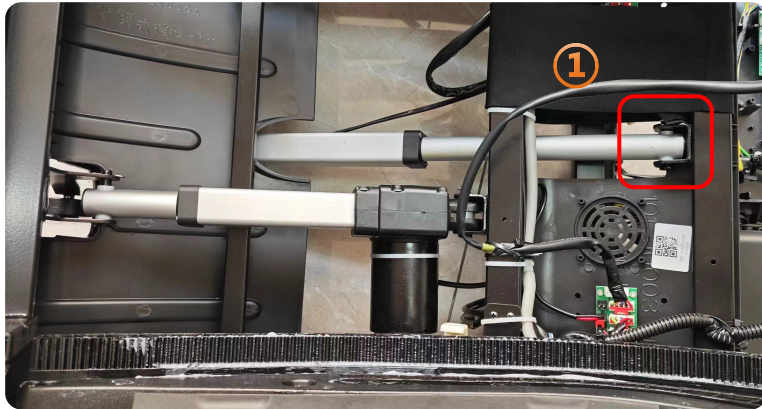

1. Remove the fixed pin①
2. Lay the chair flat on its side②
3. Cut off the fixing cable ties③

4. Unplug the terminals④
5. Remove the fixed pin⑤
6. Remove the backrest actuator

backrest
actuator

4. Analysis and Repair of Massage Chair Faults

1. The whole chair is not working.

2. Kneading and Knocking do not work.

3. The mech cannot move up and down.

4. The backrest or the footrest actuator does not rise or down.

5. The roller of the foot do not work.

6. The backrest or foot heat therapy doesn't work.

7. No music function.

8. A certain group of air pressures is not working.

4. 1. 1 • Analysis and Repair of Massage Chair Faults

The whole chair is not working

1. The tablet is damaged, can't start up. The method of replacing the tablet is adopted. (Pic1)

①



Analysis

2. Check if the main switch is on and inspect if the fuse is blown. Generally, it is caused by a short circuit in the main PCB or power switch board. Replace the main PCB & fuse (Pic2)

②

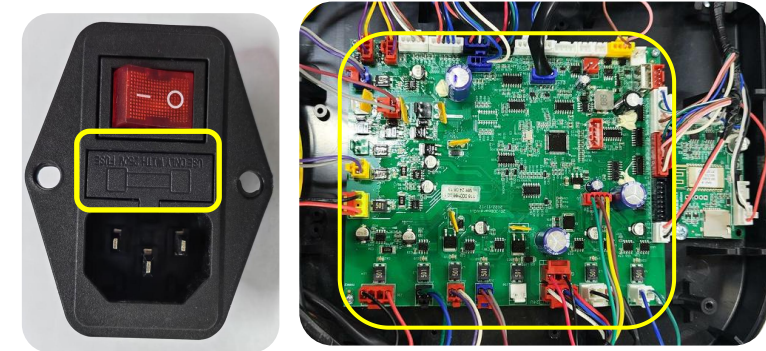

3. Check the power board to see if there is a 120V input & a 5V output. Replace the power board if there is no 5V voltage, & replace the main board (Pic3)

③

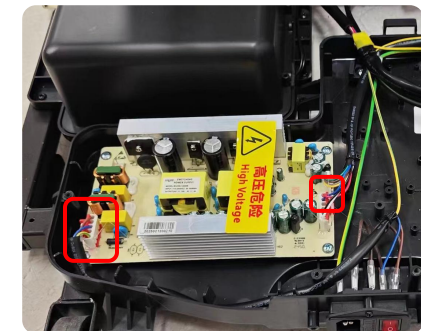

4. 2. 1 • Analysis and Repair of Massage Chair Faults

Kneading and Knocking do not work.

1. First, check if there is poor contact in each harness plug-in from the PCB to the kneading motor and whether there is voltage output (Pic1)

①

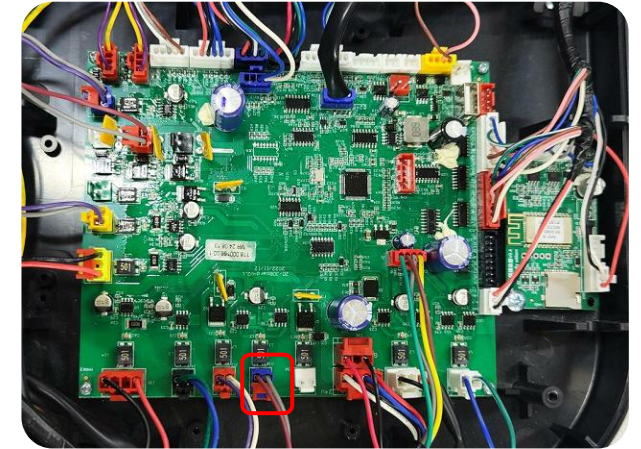

Analysis

2. Remove the back cover and measure if there is voltage in the plug on the back cover of the mech (Pic2). If there is voltage, it indicates that the motor is damaged. There is no problem with the voltage harness or the board type.

②

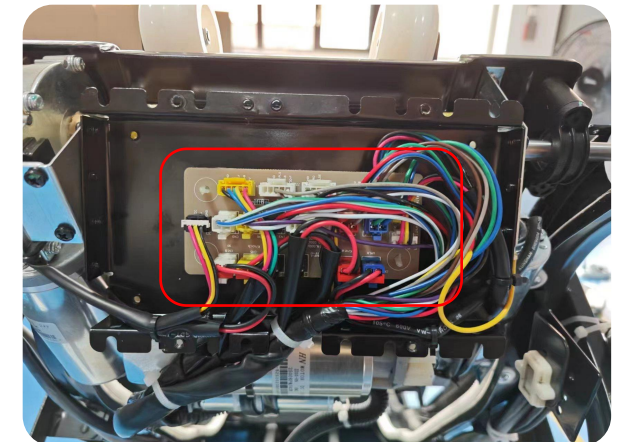

3. In the absence of a multimeter, the condition of the motor can be confirmed by substitution (by interchanging the kneading and knocking plugs).

4. 3. 1 • Analysis and Repair of Massage Chair Faults

The mech can't move up and down.

Analysis

1. First confirm and check whether there is any poor link or loose plug-in in the harness.
2. To determine whether a motor is damaged, you can use tapping the power supply of the motor to judge its condition (Pic1).
3. Determine whether the upper and lower limit detection plates are damaged or whether the upper and lower magnets have fallen(Pic 2)
4. In the absence of a multimeter, the condition of the motor can be confirmed by substitution (by interchanging the walking and kneading or tapping plug).
5. Measure whether there is an AC24V output at the PCB terminals and whether the PCB is damaged (Pic3).

①

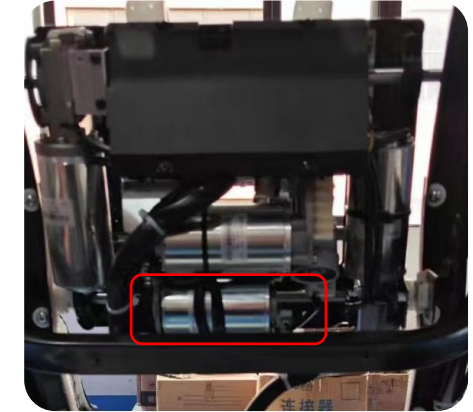

②

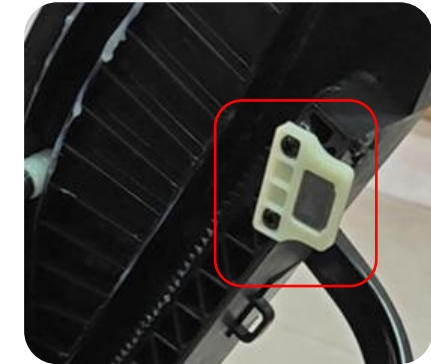

③

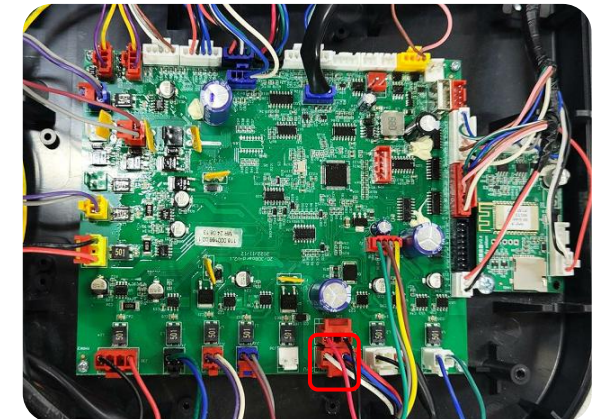

4. 4. 1 • Analysis and Repair of Massage Chair Faults

The backrest or the footrest actuator does not rise or down.

1. Check whether there is poor link at the harness terminals from the PCB to the actuator (Pic1)

Analysis

2. Use a multimeter to measure whether there is voltage output from the PCB. If there is no voltage output, replace the PCB (Pic2).

3. First, hold down the actuator lying button and listen to the "beep, beep," sound from the tablet. Then check if the chair moves up or down to determine if the actuator is faulty and replace it.

①

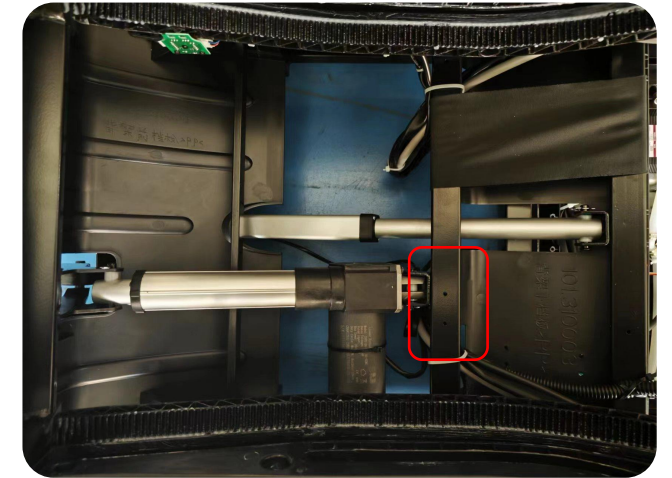

②

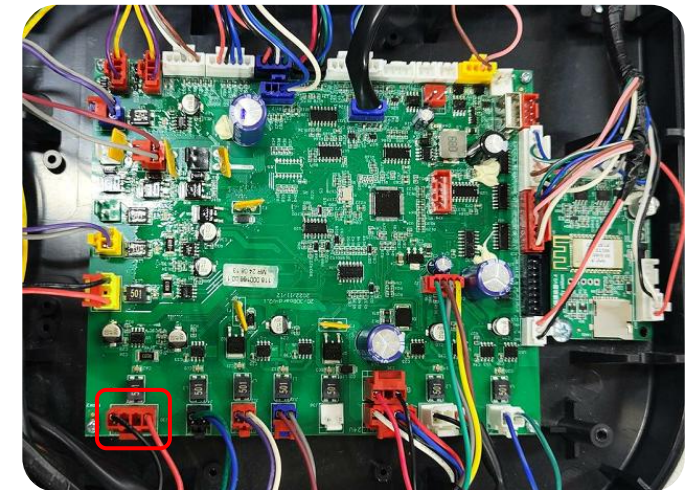

4. 5. 1 • Analysis and Repair of Massage Chair Faults

The roller of the foot do not work.

Analysis

1. First, check if there is any poor link or loose plug-in in the wiring harness. (Pic 1)

2. Use a multimeter to measure whether there is a DC24V at the terminal (Pic 1). If there is no voltage, it indicates that the PCB and harness are damaged and need to be replaced. If there is voltage, it indicates an internal fault in the leg.

3. Disassemble the leg to check if the terminals of the harness have come off. If they have, just reinsert them properly (Pic2).

4. If the foot adapter is in good condition and the harness is normal, it can be determined that the roller motor is damaged and needs to be replaced (Pic 3).

①

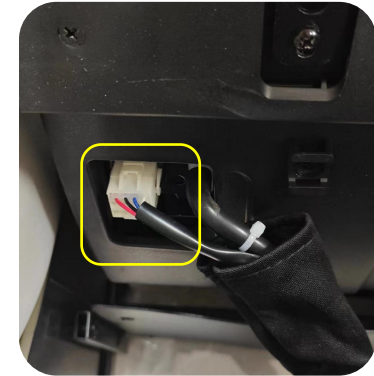

②

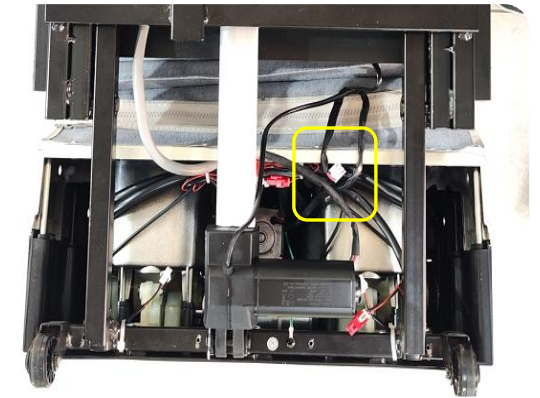

③

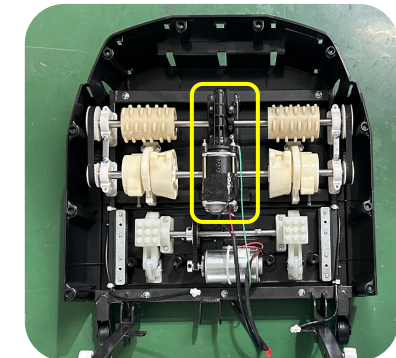

4. 6. 1 • Analysis and Repair of Massage Chair Faults

The backrest or foot heat therapy doesn't work.

Analysis

1. Check if there is poor link or detachment at the terminal of the heating wire on the backrest (Pic 1)

2. Use a multimeter to measure whether there is AC24V at the terminals of the PCB. If there is damage to the PCB, replace it (Pic 2)

3. Use a multimeter to measure whether there is AC24V at the terminals of the PCB. If there is a voltage output, check the harness. If the communication of the harness is normal, replace the heating plate (Pic 3)

①



②

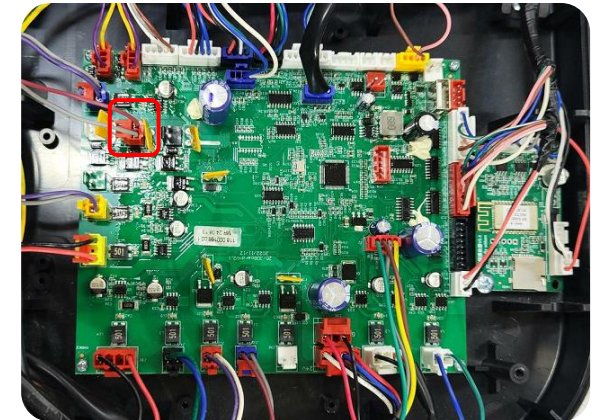

③

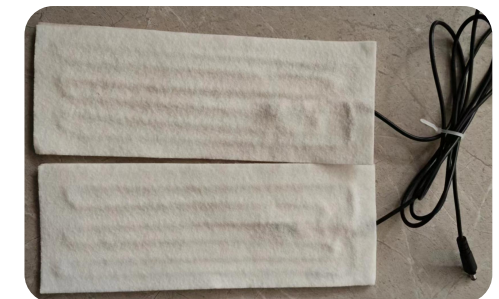

4. 7. 1 • Analysis and Repair of Massage Chair Faults

No music function

Analysis

1. Phones can't found the bluetooth name after the chair on:
 A. check that the tablet bluetooth switch is on (Pic 1)
 B. to turn off the power to search again after waiting for 3 to 5 minutes, still can't search to replace the bluetooth PCB.

2. Phone is successfully paired with bluetooth. Check whether the contact of the bluetooth PCB harness is normal. If not, replace the bluetooth PCB (Pic 2)

3. Check whether the cable from the Bluetooth PCB to the speaker is in poor link.

4. If one side of the speaker does not sound, check the harness and replace the speaker (Pic 3)

①

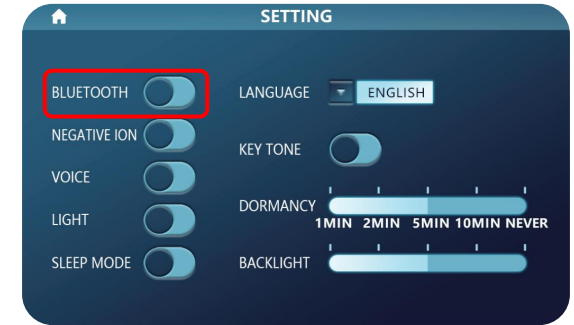

②

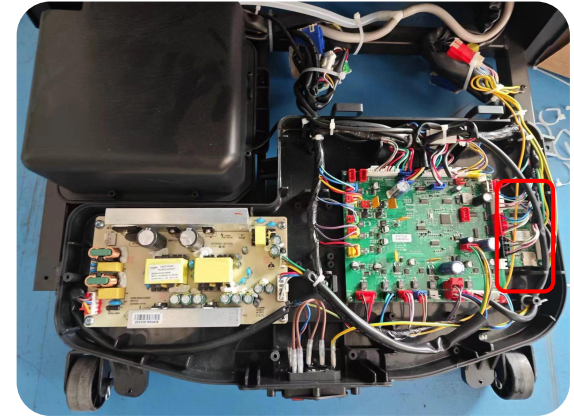

③

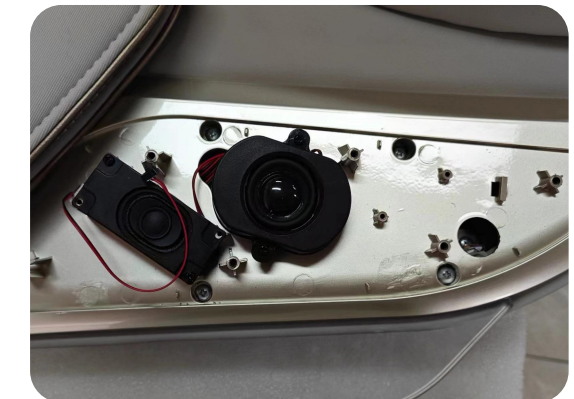

4. 8. 1 • Analysis and Repair of Massage Chair Faults

A certain group of air pressures is not working

①

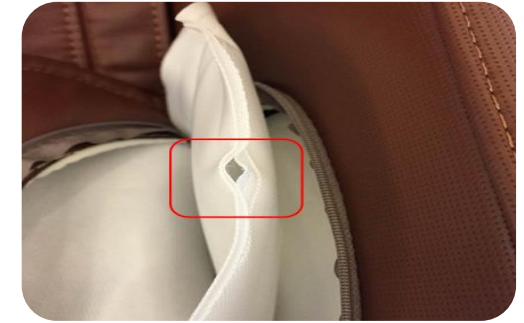

1. Check whether the air bag of this way is cracked and whether the air pipe is bent (Pic 1)

②

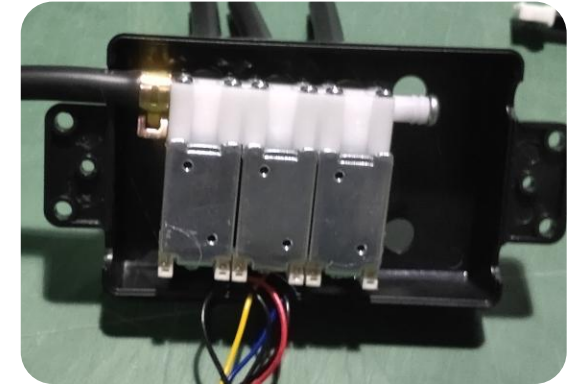

2. Check whether the air valve controlling the air pressure of this circuit is damaged (Pic 2)

③

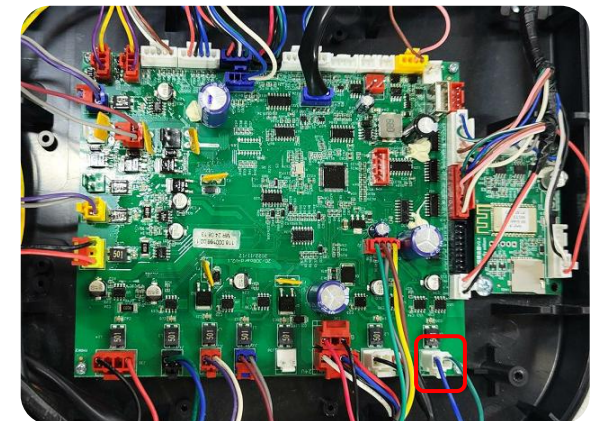

3. Use a multimeter to measure whether the terminal voltage of the PCB is output. If there is no voltage output, replace the PCB (Pic 3)

Analysis

5.Tool list

							
Multimeter	Test pen	Hex wrench	Nipper pliers	Rubber tape	Cable tie	Vice jaw	Electric drill



Thank you

Service dept

