

Service Manual



Model: 4D Aria

Service Dept

Contents

1.Product parameters and function introduction

2.Structure of massage chair

3.Disassembly diagram of massage chair

4.Analysis and Repair of Massage Chair Faults

5.Tool list



1. Product parameters & function introduction

1.Product Parameter

2.Product function

3.Tablet description

4.Product size

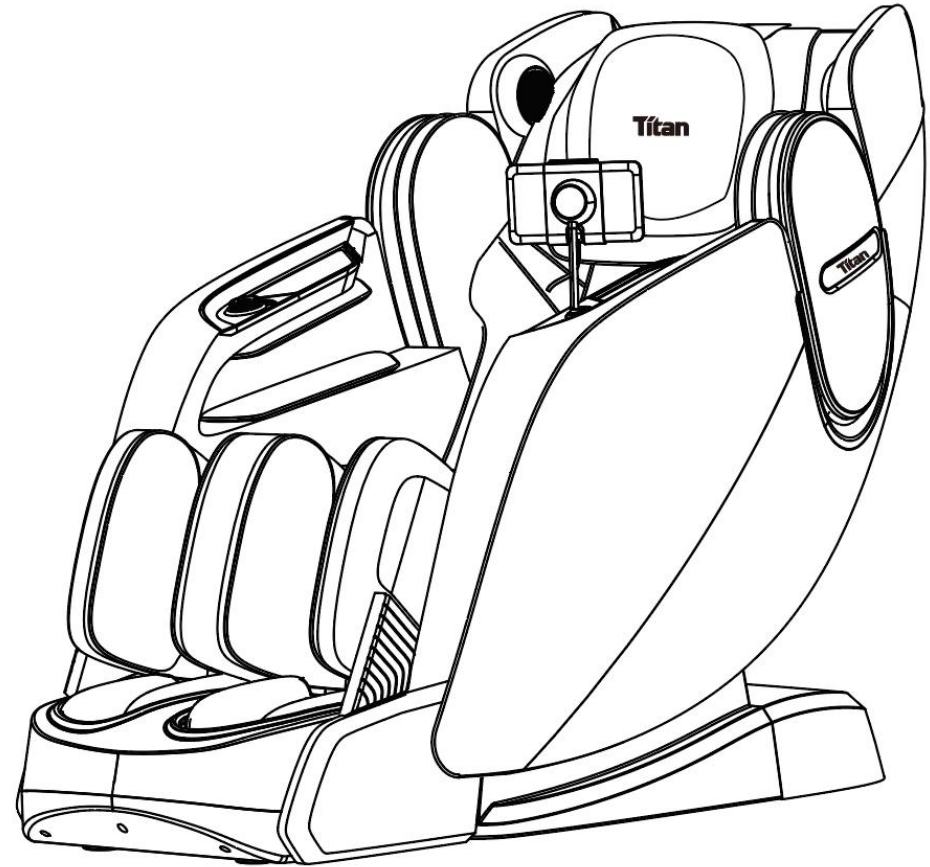

1.1.1·Product Parameter

Product Specification	Product Description
Product name	Massage Chair
Model No.	Titan Pro 4D Aria
Rated frequency	60HZ
Rated voltage	110V ~
Rated power	180w
Safety design	Class I
Net weight	198.4 lbs
Gross weight	251.3 lbs
Product size	64.6 * 31.1 * 46.1

1. 2. 1 • Product function

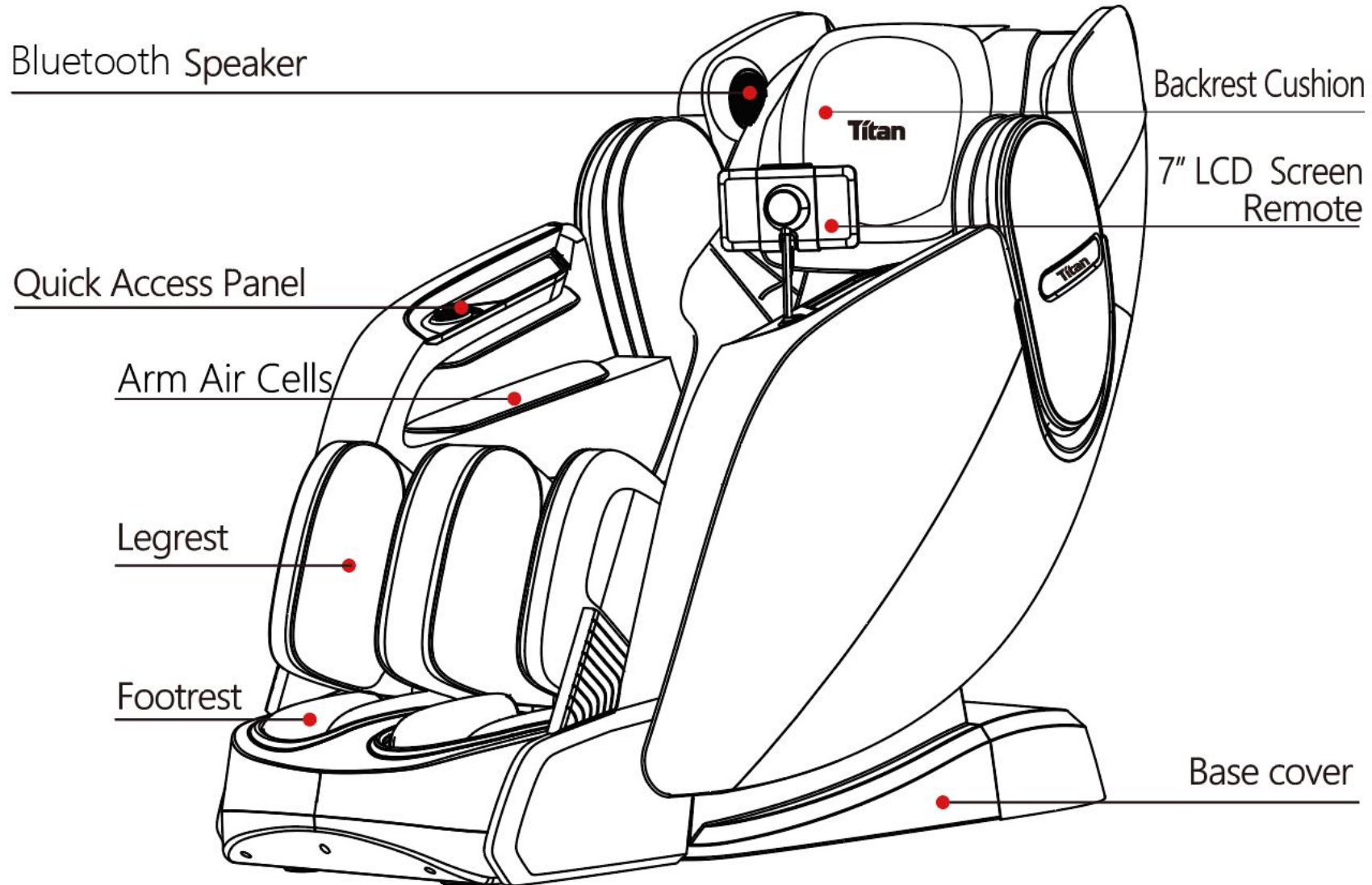

1. 3. 1 • Tablet description



1. Turn on LCD SCREEN to start massaging.

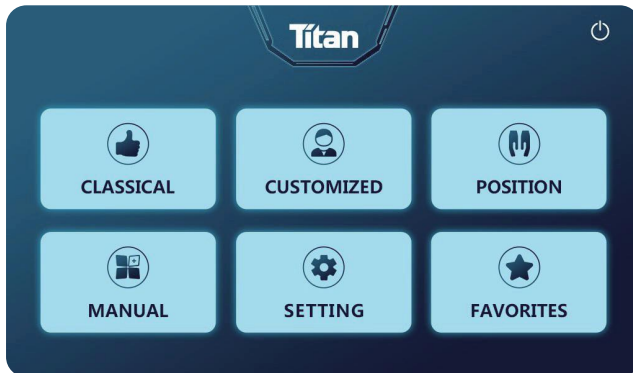

2. There are six option on the home page: CLASSICAL, CUSTOMIZED, POSITION, MANUAL, SETTING, FAVORITES.



3. After selecting the CLASSIC mode, there are 8 programs: DEMO (Massage 5 mins only), THAI STRETCH, BODY CIRCULATION, RELAX, MORNING CARE, MIDDAY CARE, NIGHT CARE, DEEP TISSUE.

1.3.1 • Tablet description



4. After selecting the CUSTOMIZED mode there are 8 programs: EXTENSION, WOMEN'S HEALTH, SHIATSU, MEN'S HEALTH, OFFICE RELIEF, SPORTS RECOVERY, FOOT CARE, REJUVENATE.



5. After selecting the POSITION mode, there are 8 programs: NECK MASSAGE, NECK AND SHOULDER MASSAGE, BACK MASSAGE, LUMBAR MASSAGE, WAIST & HIP MASSAGE, LEGS MASSAGE, UPPER BODY, LOWER BODY.

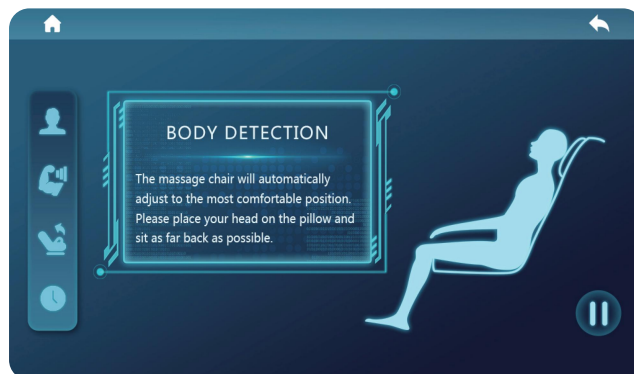

6. After selecting the automatic massage program, the chair will start conducting a body scan. To enjoy the most comfortable massage, please place your head on the pillow and sit as far back as possible.

1. 3. 1 • Tablet description

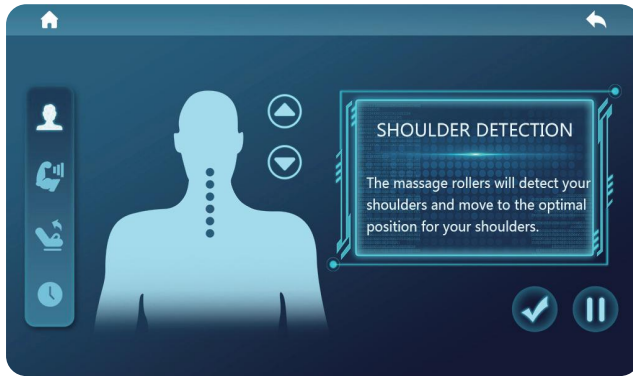

7. After the body scan, the shoulder detection will begin where the massage rollers will move from the top to the optimal shoulder positions.



8. After selecting the MANUAL mode, it will enter the MANUAL mode page: In this page, you can select the body parts of the air cells massage, such as the FULL BODY, SHOULDER, HAND, WAIST & HIP, LEG & FOOT massage, or you can select the massage action: like KNEADING, PERCUSSION, ACUPRESSURE, FLAP, SLAP, MIXTURE.



9. In MANUAL mode massage position page, you can control the massage hand position through FIXED POINT, FULL BODY, AREA, UP and DOWN. In "full body" mode, "up" and "down" are invalid.

1.3.1 • Tablet description



10. In MANUAL mode OPTIONS page, you can choose the other functions you may need, such as: HEATING, LEG ROLLING, FOOT ROLLING, RANGE, WIDE, MEDIUM and NARROW.

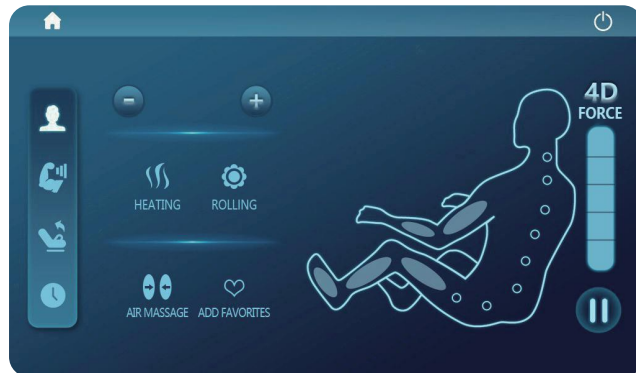

11. There are 5 functions: HEATING, ROLLING, AIR MESSAGE, 4D FORCE and ADD TO FAVORITES.

You can add your favorite massage program into ADD TO FAVORITES.

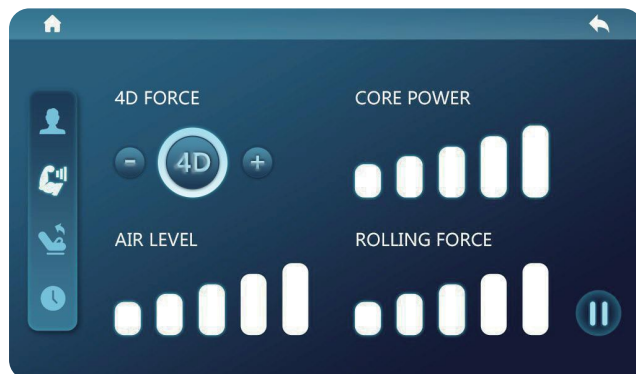

12. This button to help to control: 4D FORCE, CORE POWER AIR LEVEL and ROLLING FORCE. Note: some actions are controlled by automatic program, and manual adjustment is invalid at this time.

1. 3. 1 • Tablet description

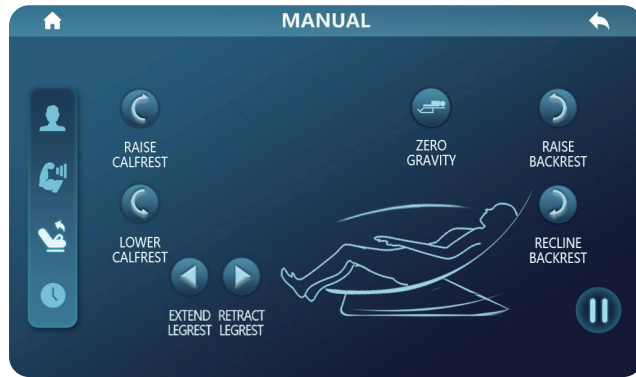

13. This button to help to control: RAISE CALFREST, LOWER CALFREST, ZERO GRAVITY, RAISE BACKREST, RECLINE BACKREST, EXTEND LEGREST, RETRACT LEGREST.

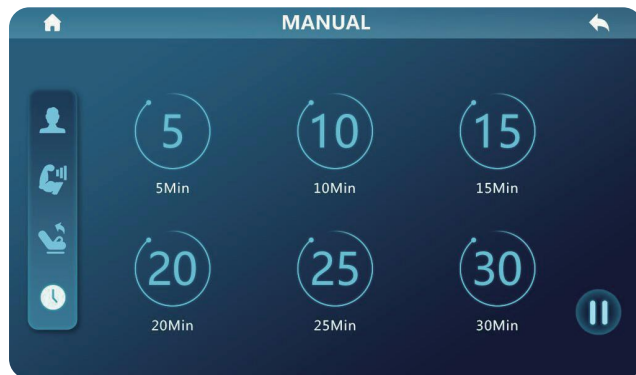

14. This button to change massage time: 5Min, 10Min, 15Min, 20Min, 25Min, 30Min.

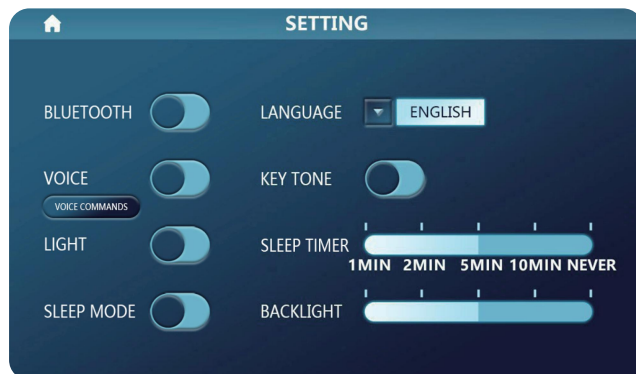

15. Home page SETTING you can control The BLUETOOTH, VOICE, LANGUAGE, KEY TONE, SLEEP TIMER, LIGHT, SLEEP MODE, BACKLIGHT.

1. 3. 1 • Tablet description

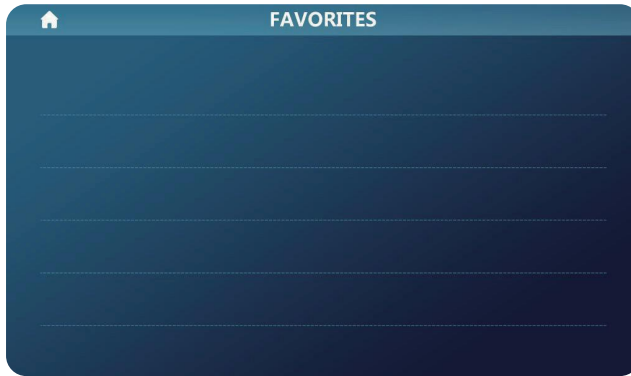

16. FAVORITES: You can add favorite programs to this page and delete them whenever you'd like.



17. Go to "SETTING" and tap the "VOICE CONTROL" icon to activate it. Then say "Hi, Titan/Hey, Titan", you will get a reply "What can I do for you?"

1. 4. 1 • Product size

Carton Size

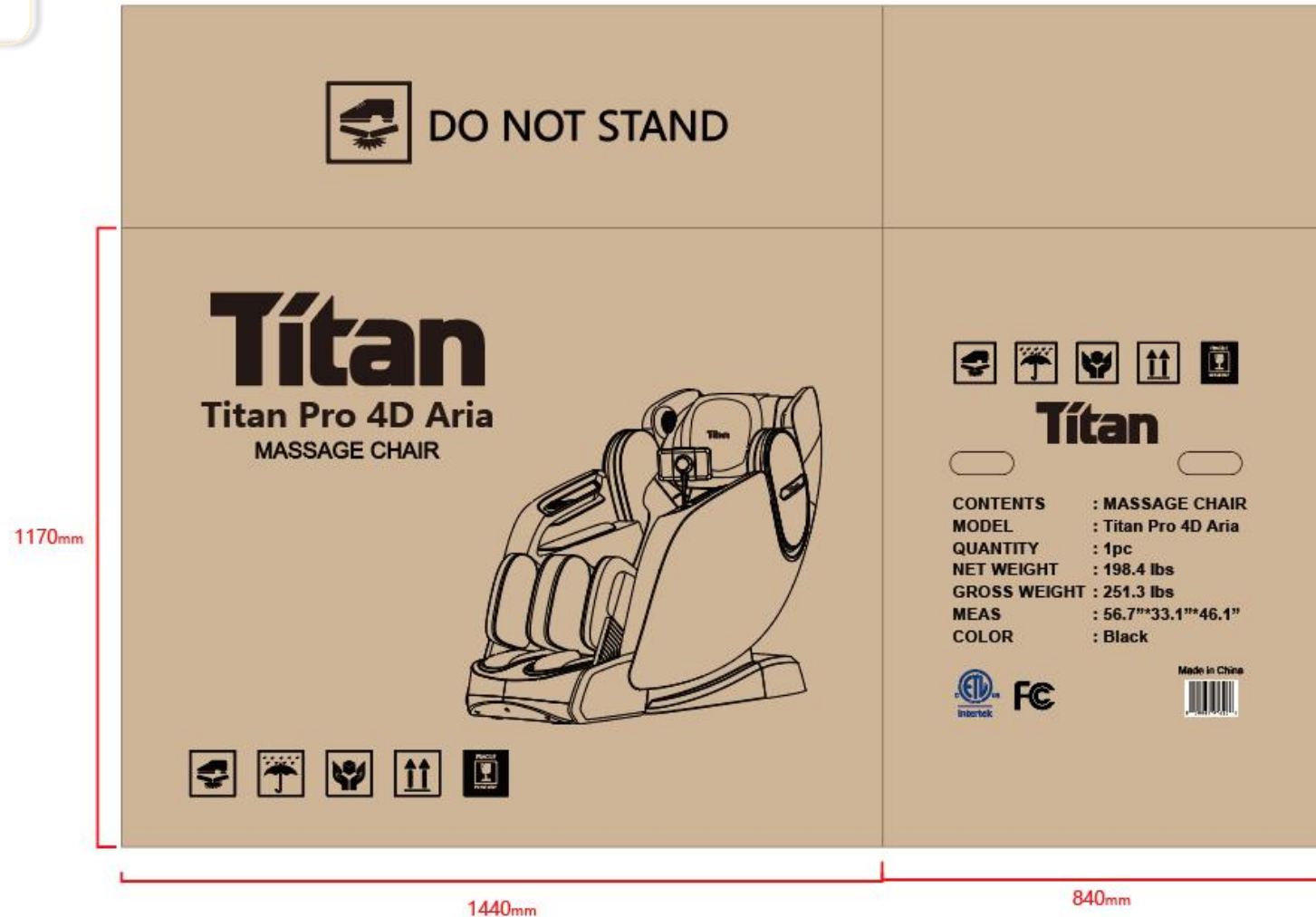

2. Structure of massage chair

1. Component name

2. Internal part drawing

3. Internal wiring diagram of power box

2. 1. 1 • Component name

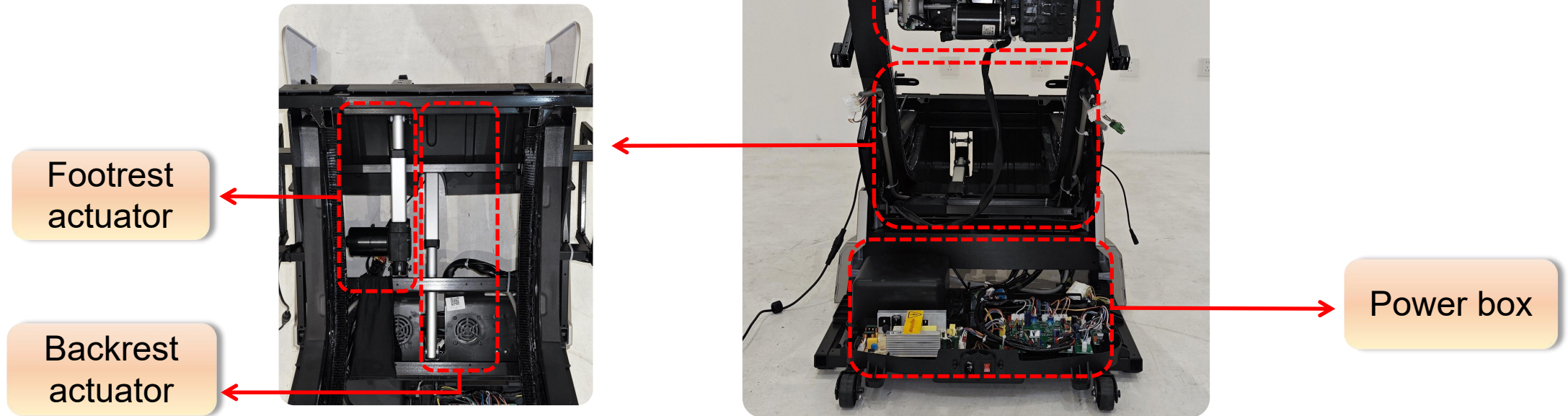

2. 2. 1 • Internal parts drawing

Main PCB

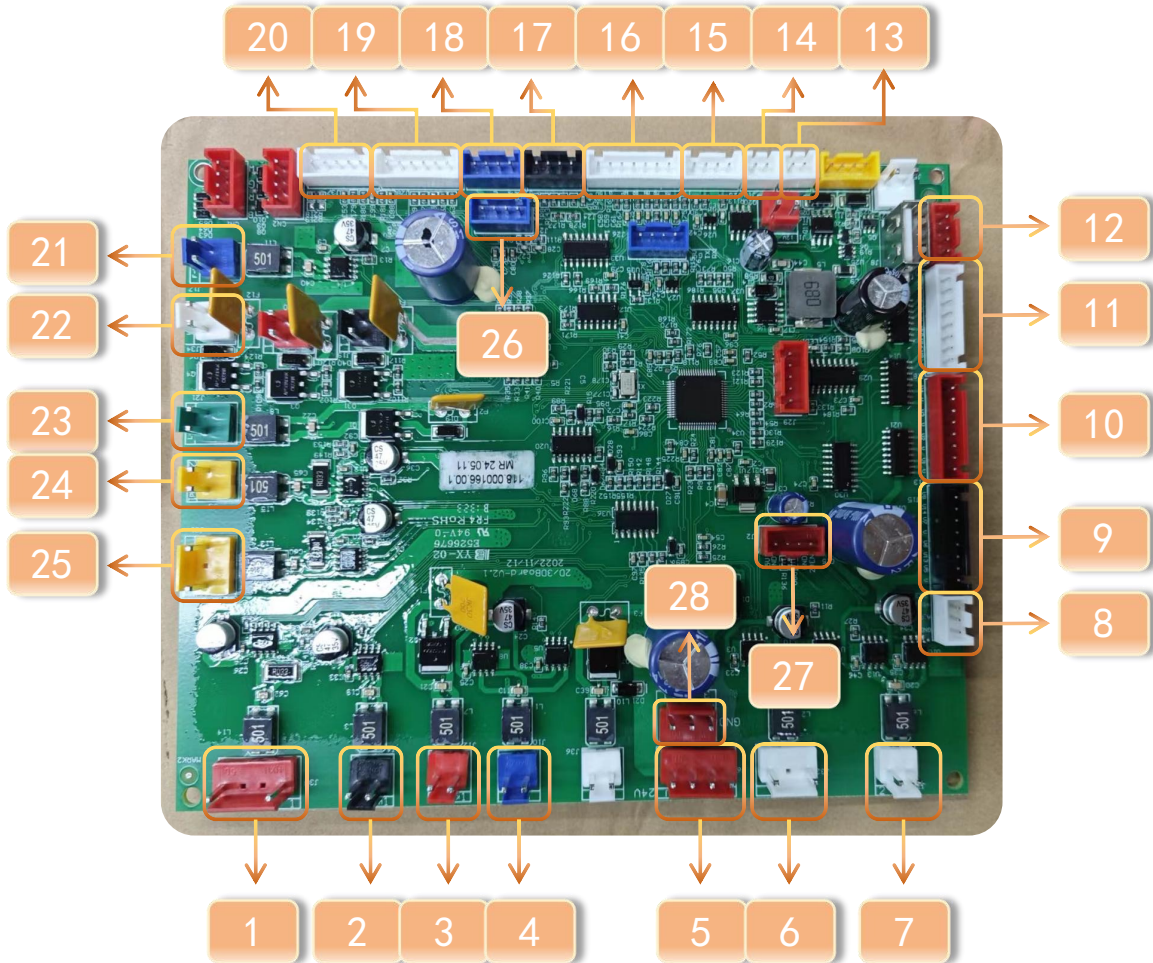

No.:	Port function	No.:	Port function	No.:	Port function
1	Footrest actuator	13	Armrest light strip	25	Backrest actuator
2	Mech walking motor	14	Armrest light strip	26	Voice control
3	Mech knocking motor	15	Remote control	27	5V input
4	Mech kneading motor	16	W M N shoulder signals of the mech,kneading,walking count, and foot signals	28	Wireless charging
5	DC24V input	17	Upper & lower limits		
6	DC24V Air pump	18	Quick access control		
7	3D mech motor	19	Anti-pinch & mech kneading counting signal		
8	Bluetooth	20	3D Mech signal		
9	Footrest air valve	21	Foot roller motor		
10	Left armrest air valve	22	Full body heating		
11	Right armrest air valve	23	Kneading plate motor		
12	Reserve	24	foot extension actuator		

2. 2. 2 • Internal parts drawing

Power board &
Bluetooth pcb

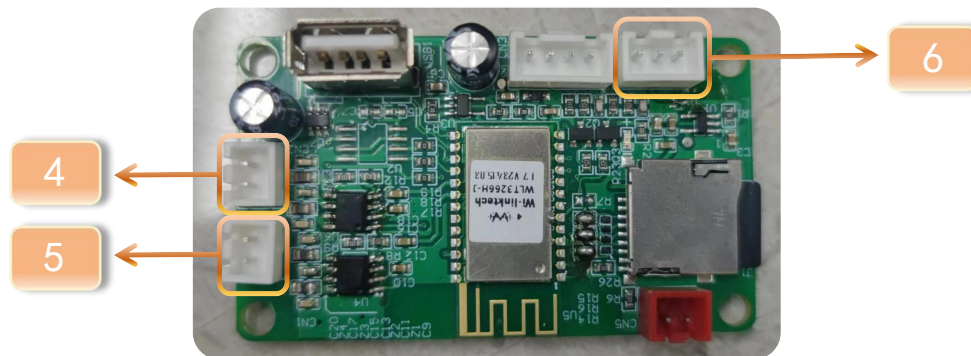

No.	Port function
1	DC5V output
2	DC24V output
3	AC120V input
4	Right audio signal output
5	Left audio signal output
6	Amplifier board control line

2. 3. 1 • Internal wiring diagram of power box

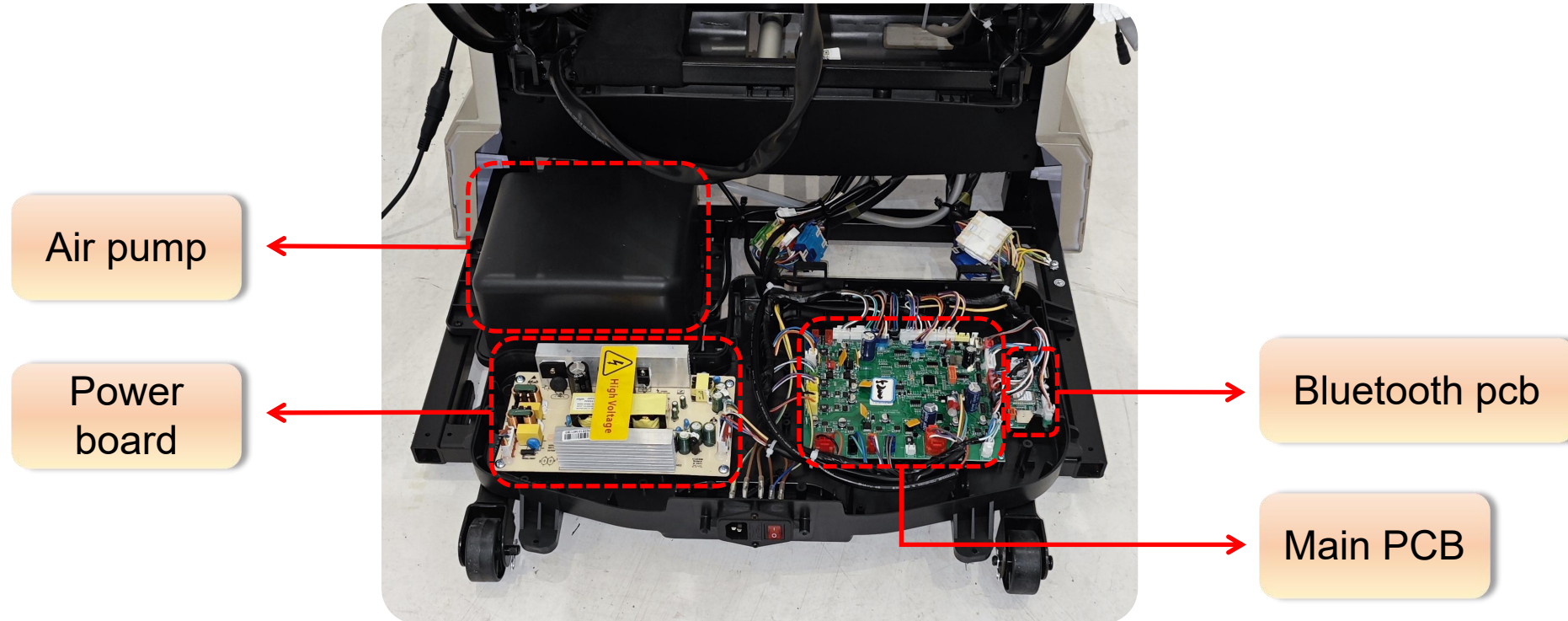

3. Disassembly diagram of the massage chair

1. Disassemble the cushion

2. Disassemble the footrest

3. Disassemble the back cover

4. Disassemble the armrest

5. Disassemble the backrest

6. Disassemble the mechanism

7. Disassemble the power box

8. Disassemble the side panel

9. Disassemble the actuator

3. 1. 1 • Disassemble the cushion

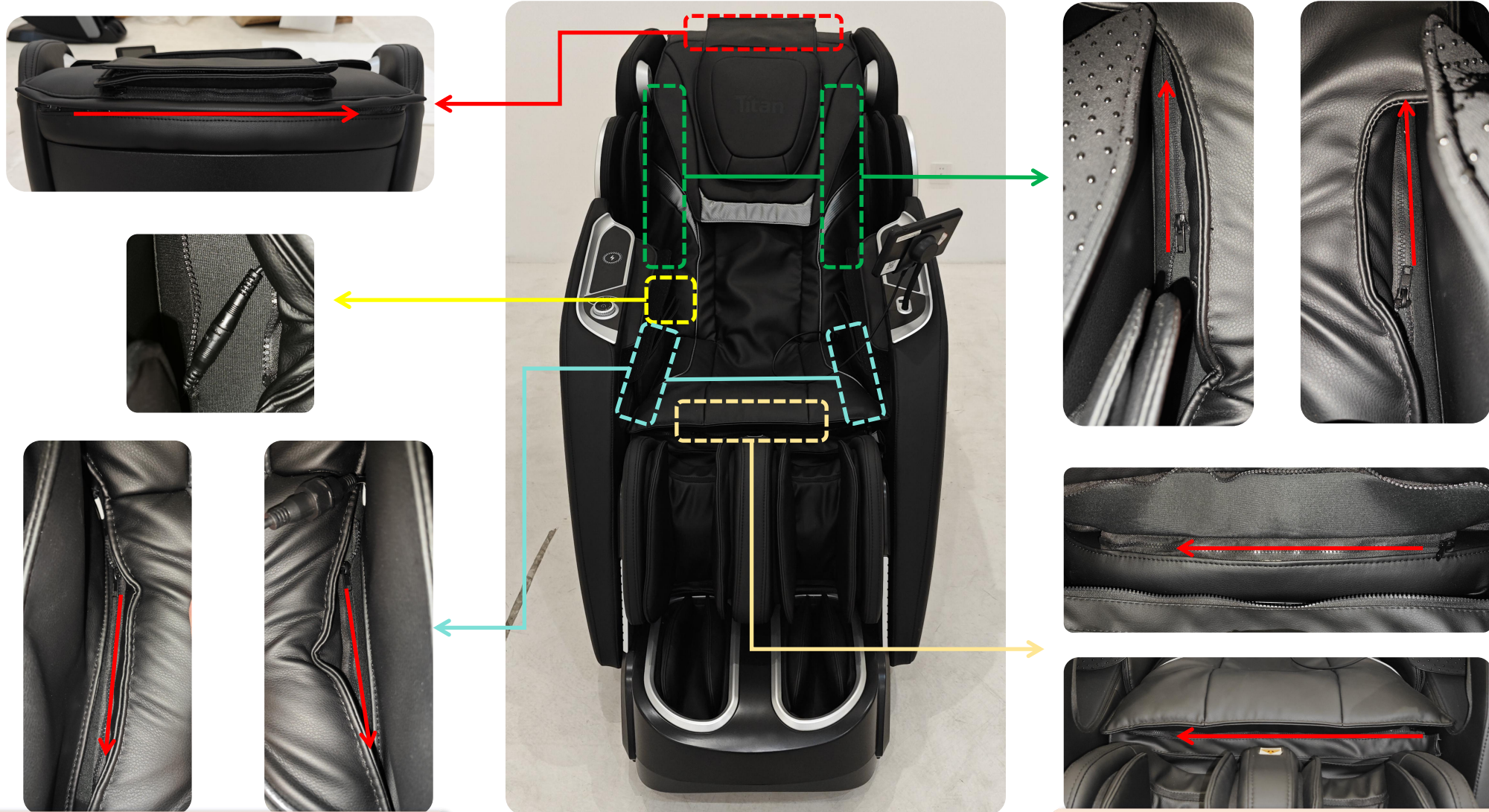

① Pull the zippers at the position

② Remove the heating terminal

3. 1. 1 • Disassemble the cushion



Cushion assy

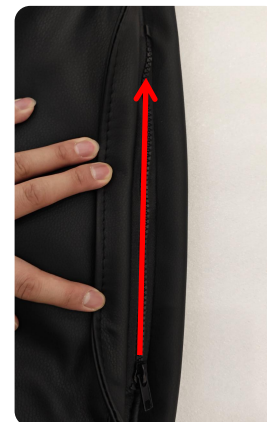

③unzip



Small pillow



Big pillow



Cushion

3. 2. 1 • Disassemble the footrest

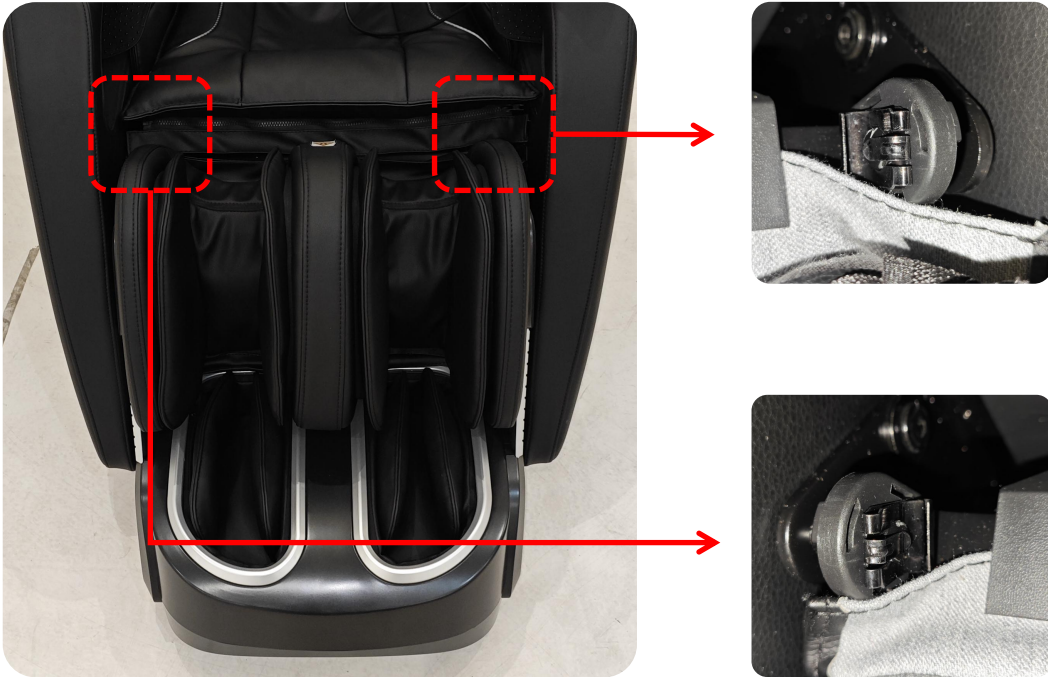

① Remove the fixing clips on both sides



② Remove the fixed buckle and pull out the air pipe & the connection terminal



Footrest assy

3. 2. 2 • Disassemble the footrest

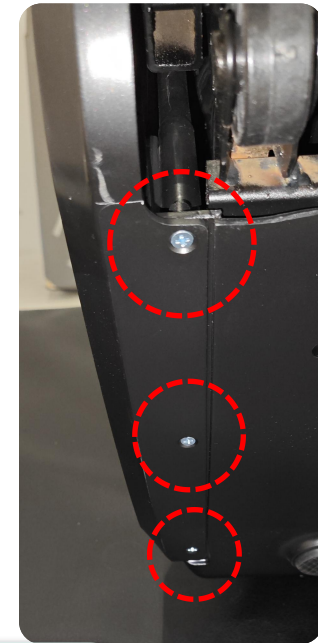

Disassemble
the footrest

① Remove 12 pcs
fixing screws

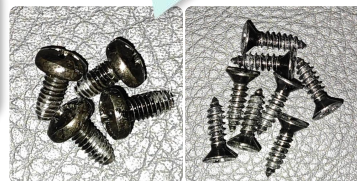

Screws
type

Back cover
of footrest



Screws
type

② Remove 6 pcs
fixing screws

3. 2. 2 • Disassemble the footrest

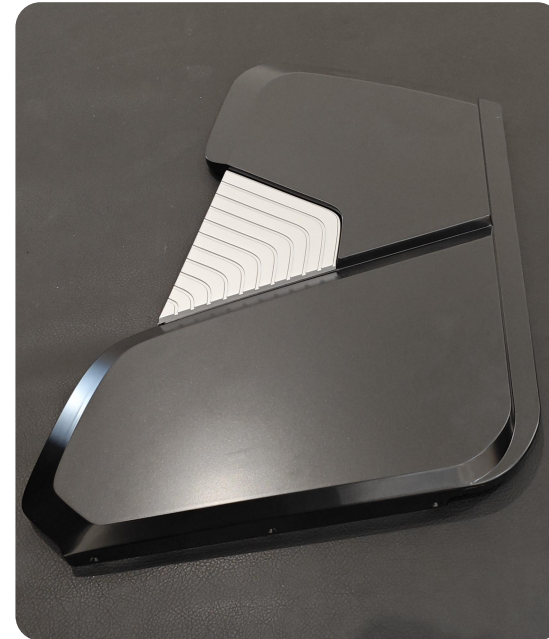

③ Remove the outer covers of both side

Left outer cover

Right outer cover

3. 2. 2 • Disassemble the footrest

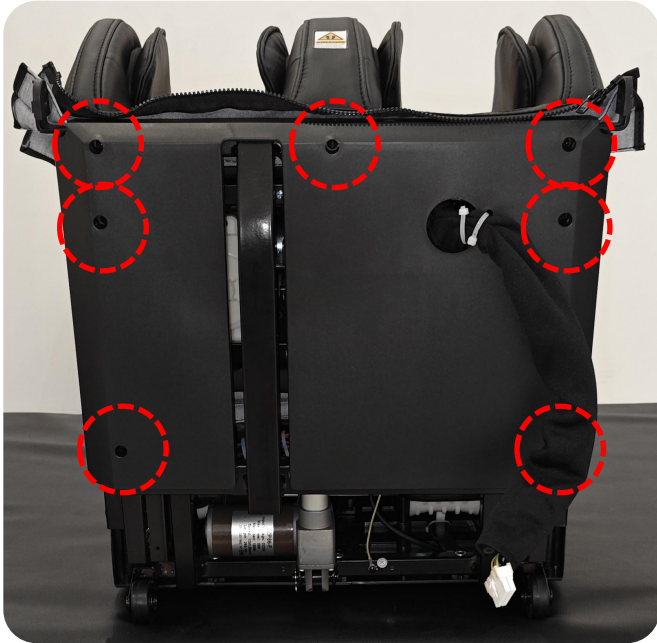

④ Remove 7 pcs fixing screws



Footrest back cover

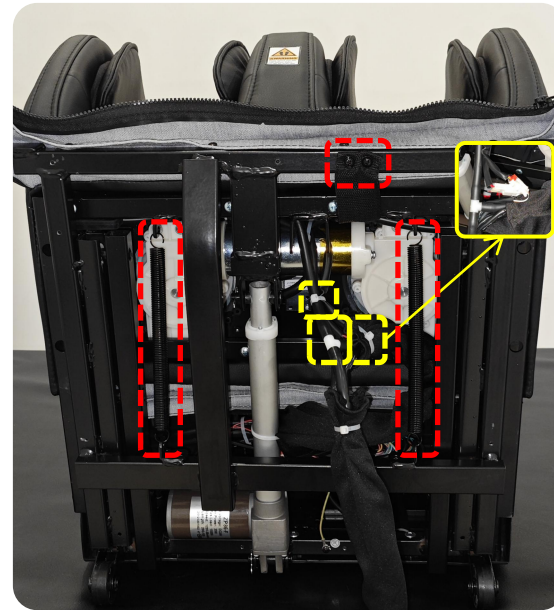

⑤ Remove the fixing screws; Cut off the fixed cable ties; Remove the connection terminal to the air pipe. Remove the limit springs on both sides. Unzip

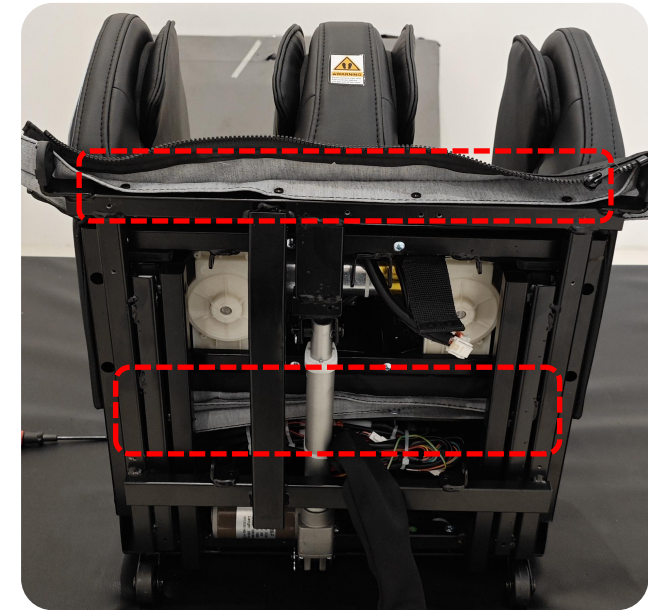

3. 2. 2 • Disassemble the footrest



Leg assy

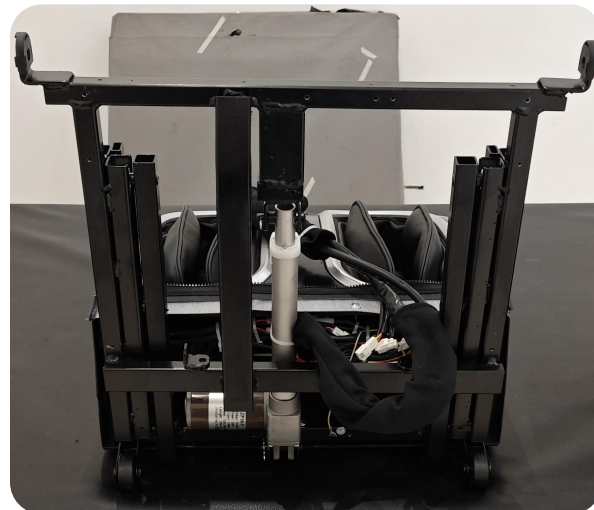

Foot assy

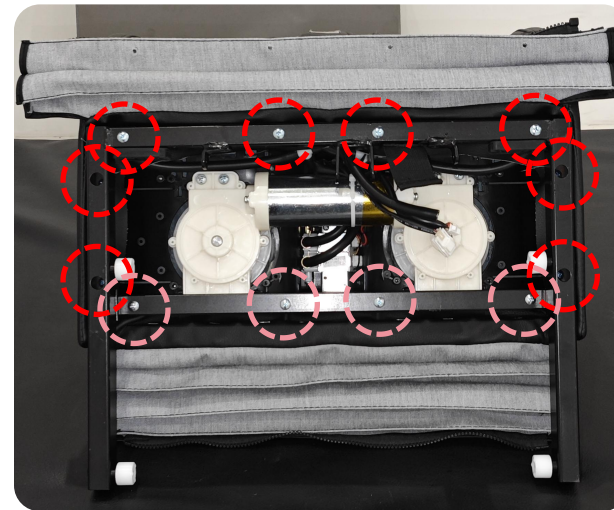

⑥ Remove 12pcs fixing screws

Screw type

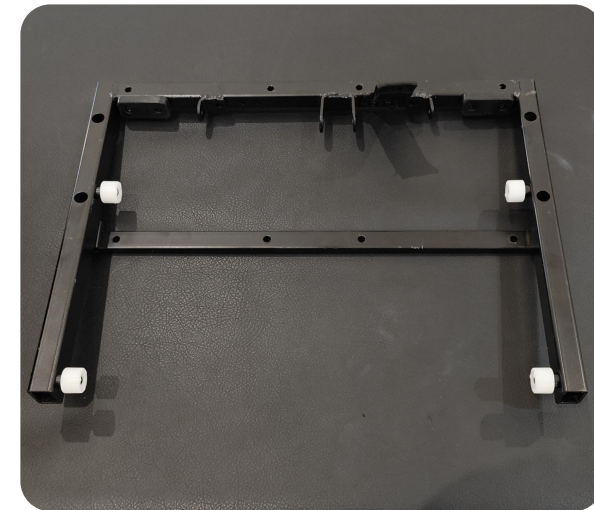

Welded part

3. 2. 2 • Disassemble the footrest

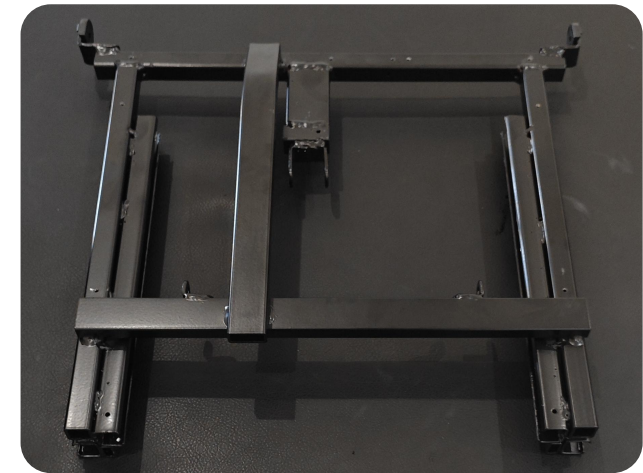
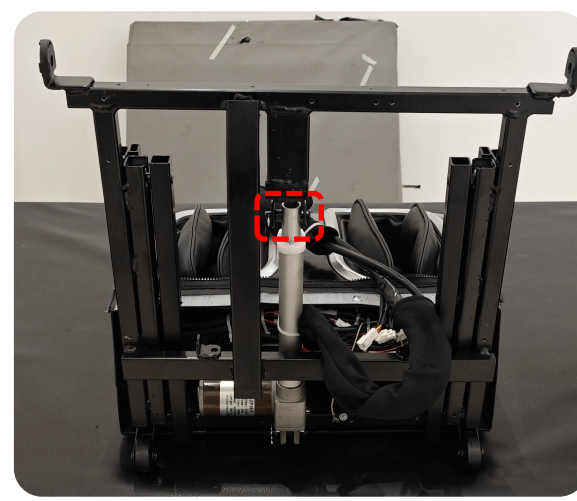
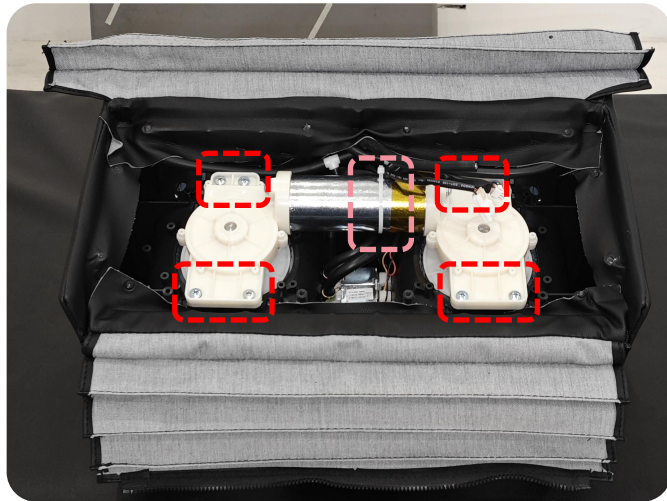

Screw type

⑦ Remove the fixing screws, Cut off the fixing cable ties



Kneading plate assy

Pin type

⑧ Remove fixing pin

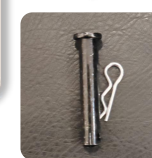

Leg welded parts

3. 2. 2 • Disassemble the footrest

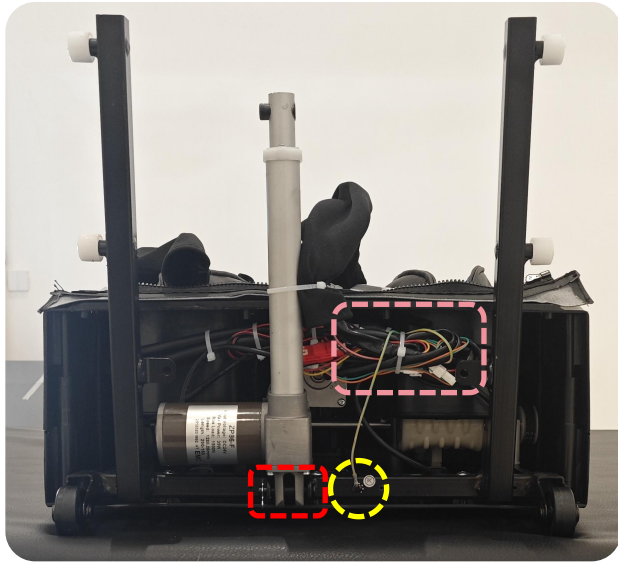

⑨ Cut off the cable ties, remove the screws, remove the pin

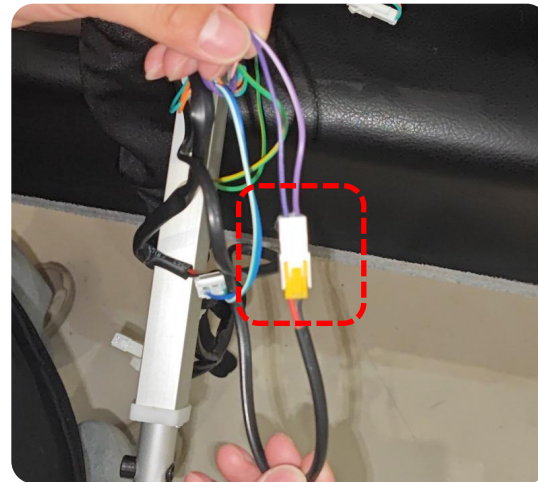

⑩ Remove the connection terminal of the actuator



Foot extension actuator

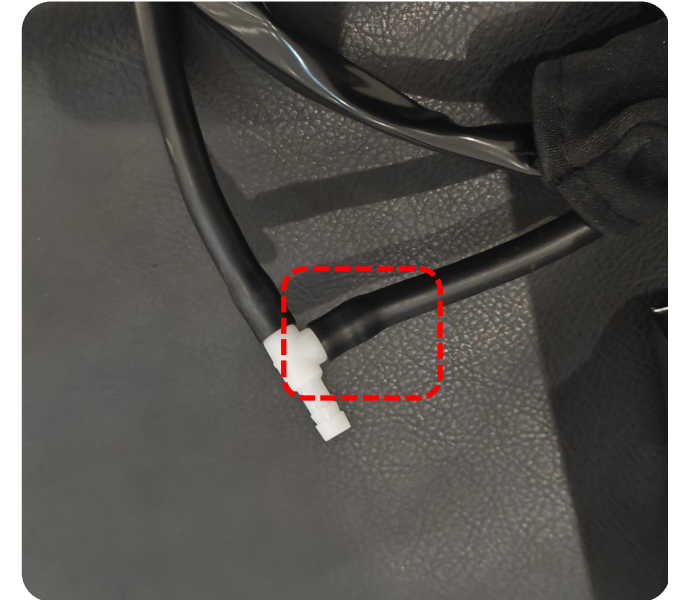

⑪ Remove the connecting air pipe

3. 2. 2 • Disassemble the footrest

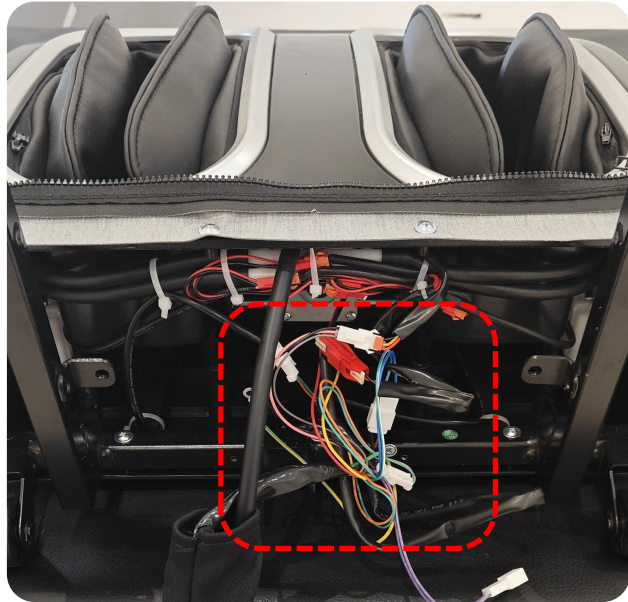

⑫ Unplug the connection terminal

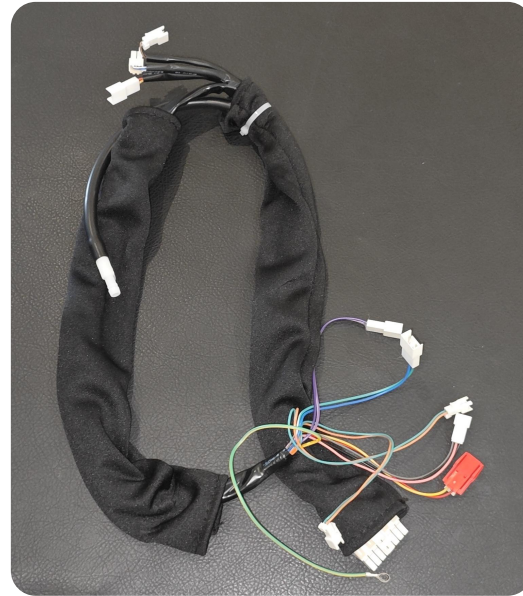

Calf wire harness C



⑬ Remove the screws

screws type



Foot upper cover assy

3. 2. 2 • Disassemble the footrest

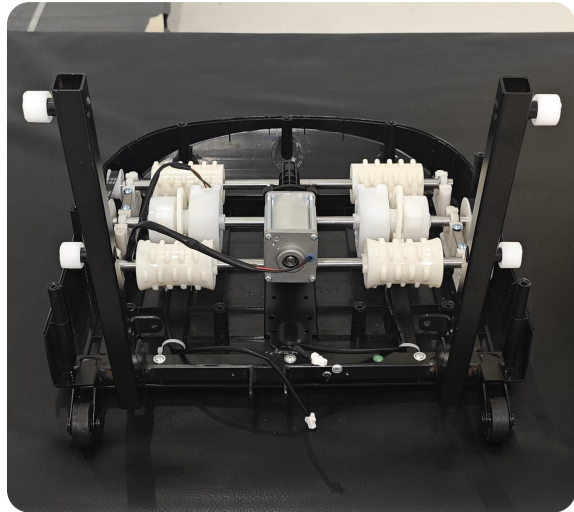

Foot lower cover assy



14 Remove the decorative ring of the left foot

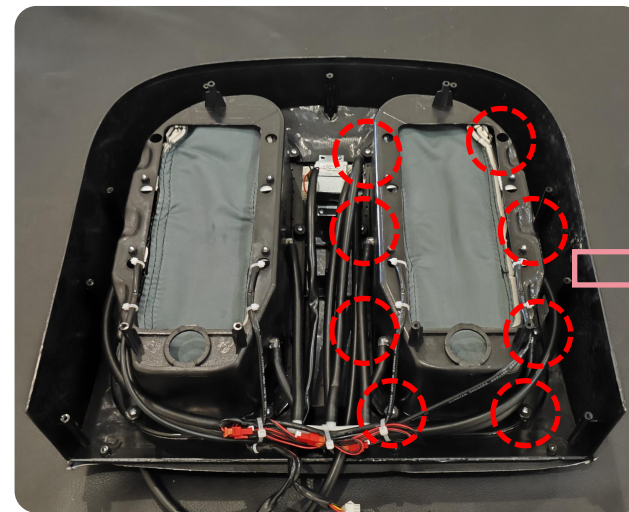

15 Remove the screws

screw type

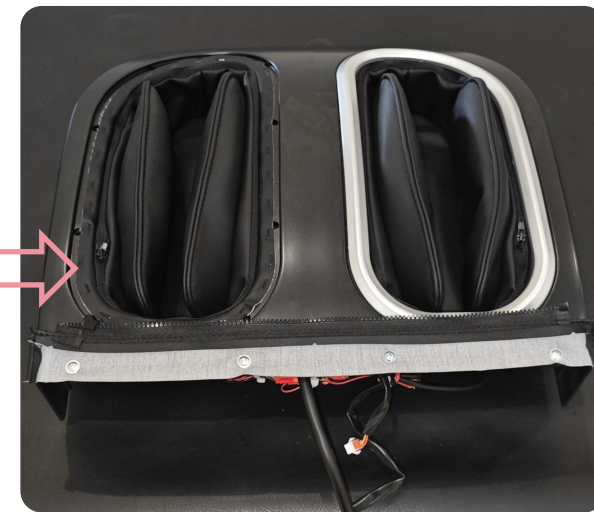

3. 2. 2 • Disassemble the footrest



Decorative ring of the left foot

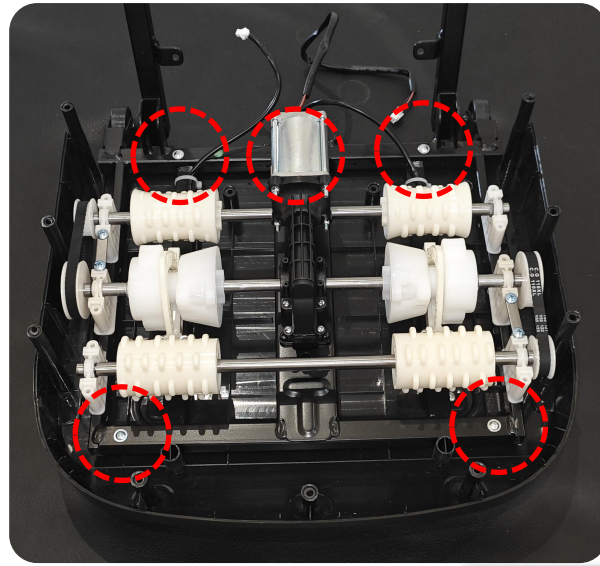

16 Remove the screws

screw type

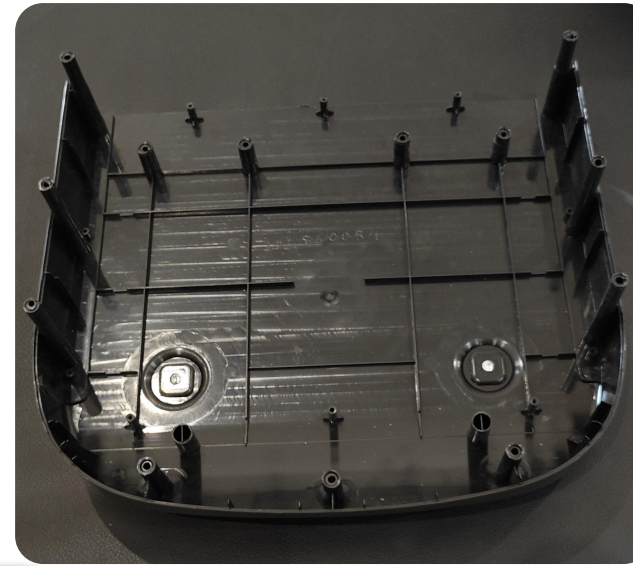

Foot lower cover

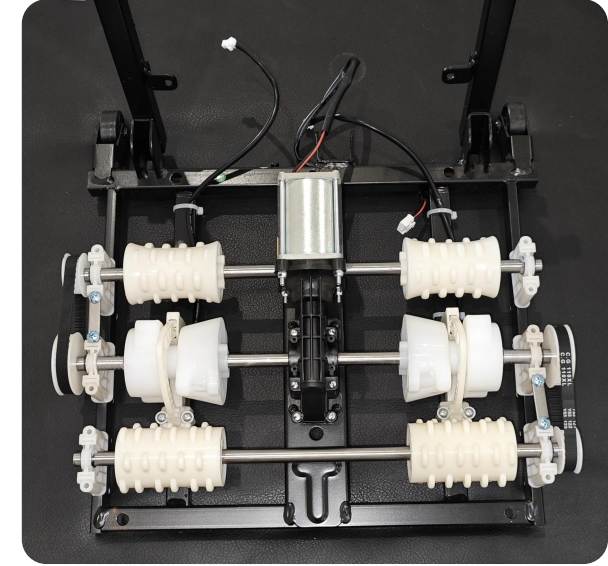

Foot roller assy

3. 2. 2 • Disassemble the footrest

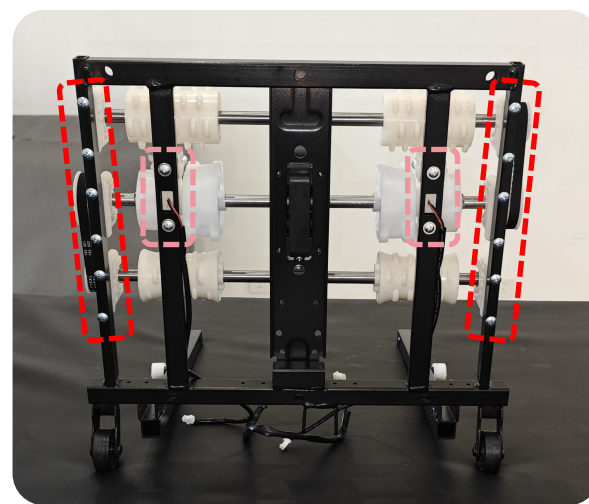
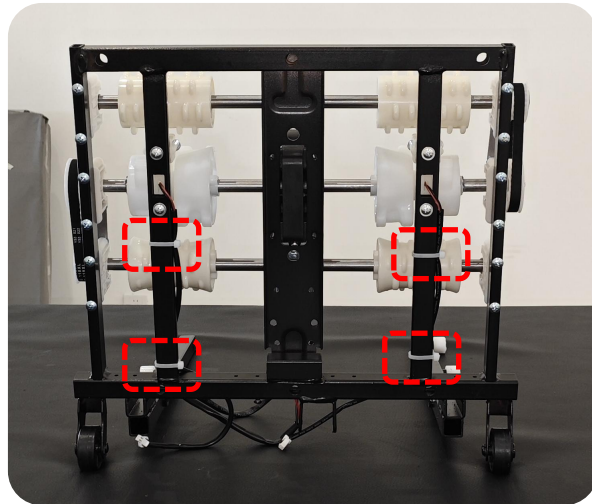
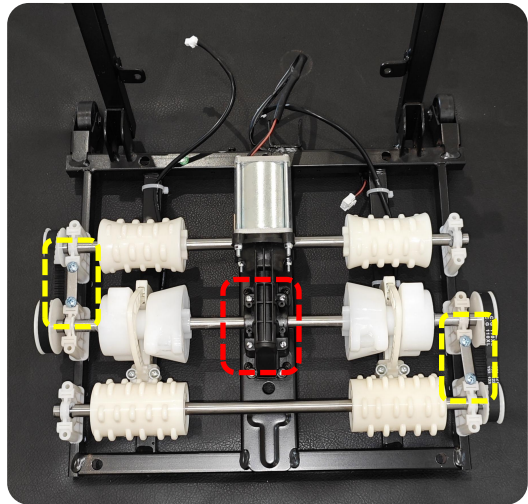

screw
type

⑰ Remove
the screws



⑱ Cut off the
cable ties

⑲ Remove
the screws

Belt

3. 2. 2 • Disassemble the footrest

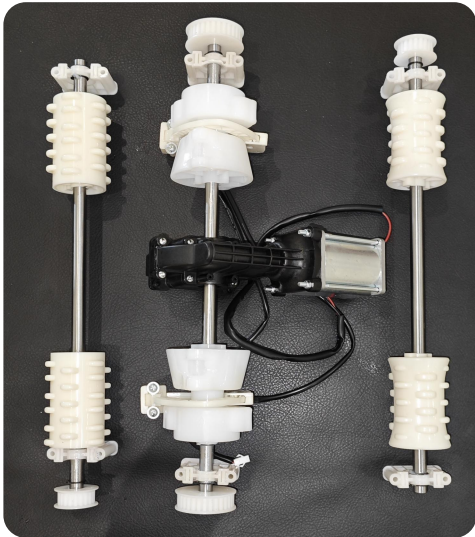

3 row roller

3. 3. 1 • Disassemble the back cover

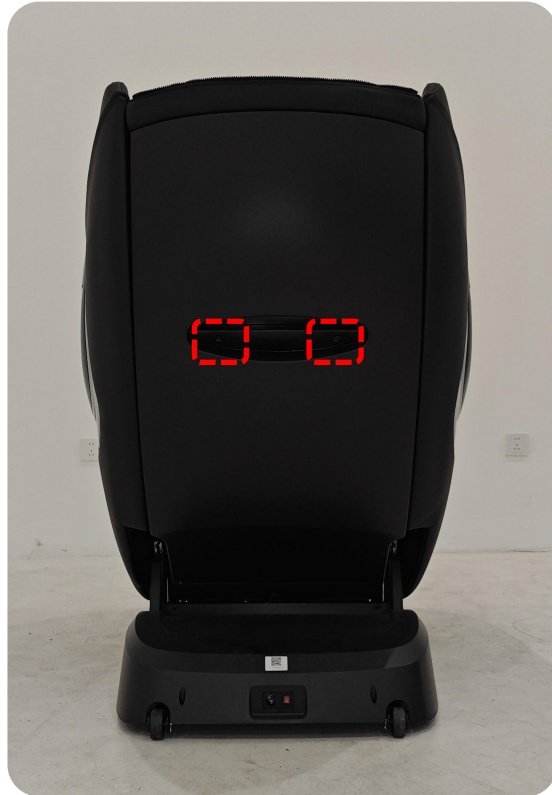

① Remove the screws

Screw type



Back cover

3. 4. 1 • Disassemble the armrest

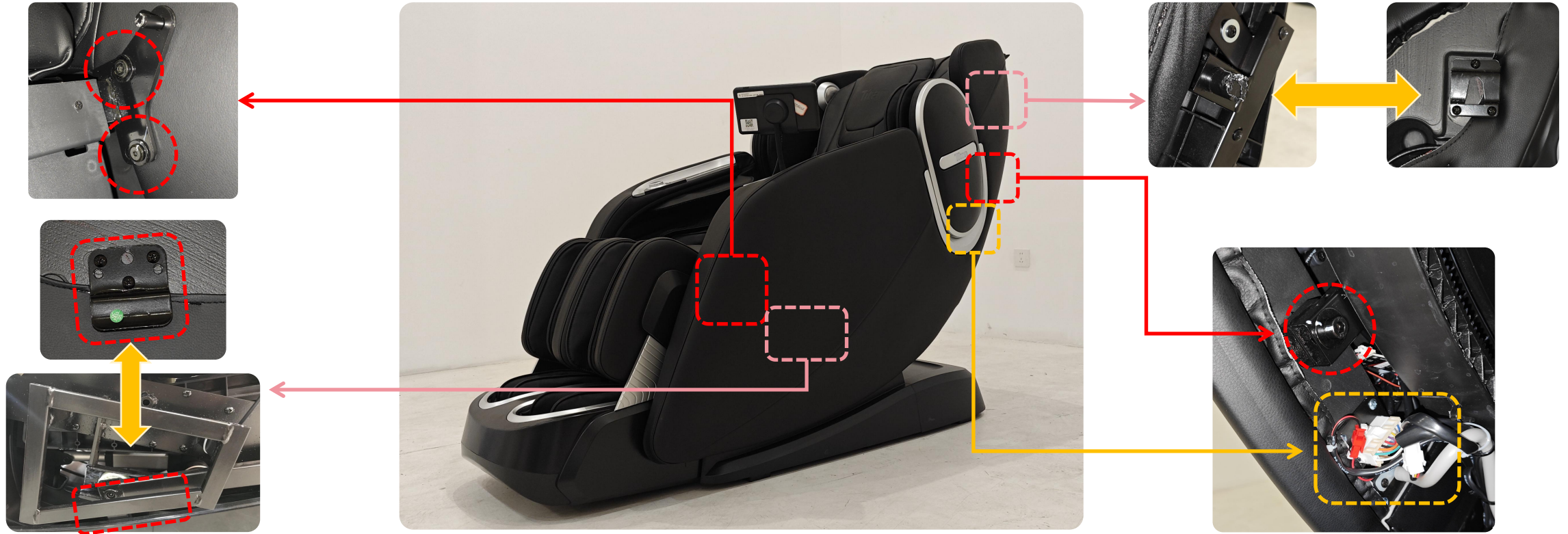

① Remove the screws that fix the front and back of the armrest

② Remove the air pipe & the connection terminal, and lift out the armrest

3. 4. 1 • Disassemble the armrest

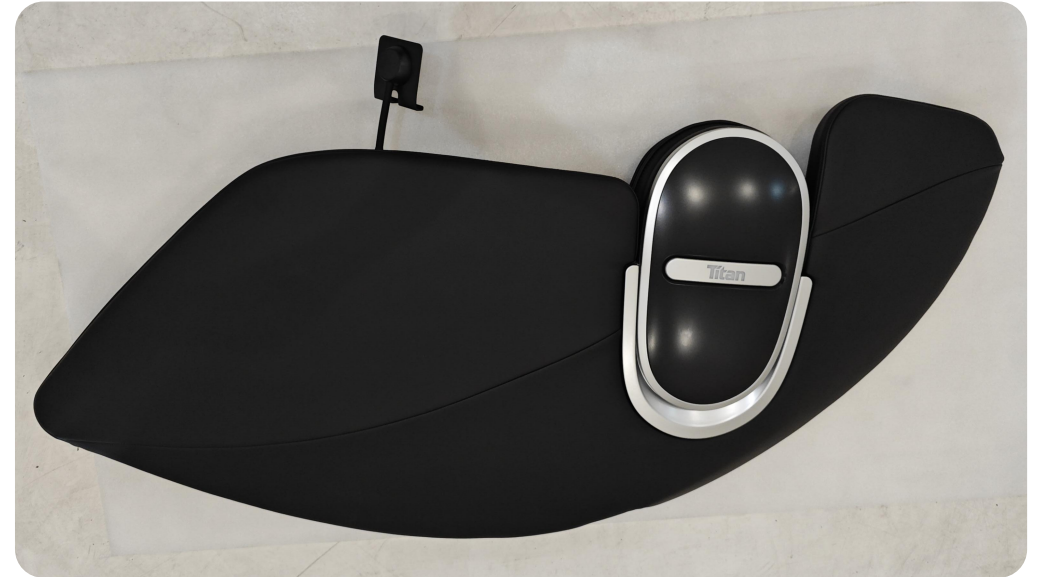

Left armrest

Note: showed the left armrest. The disassembly methods for both sides are the same.

3. 4. 1 • Disassemble the armrest

Disassembly of the decorative part on the left armrest

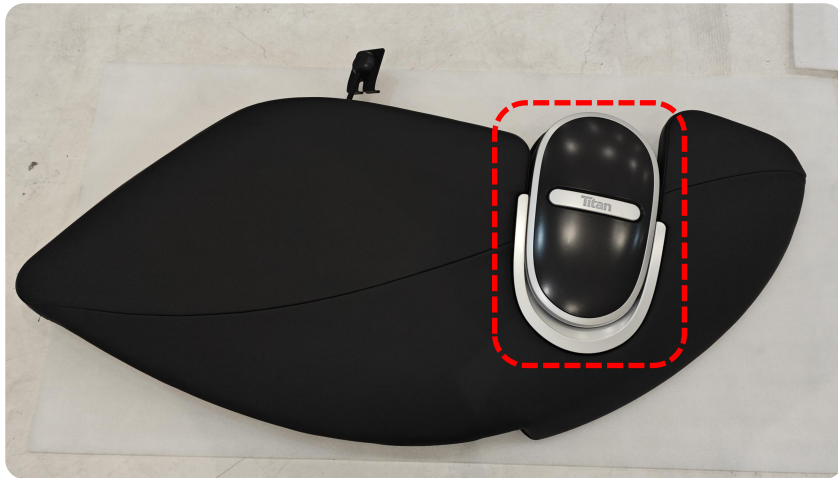

① Remove the decorative part

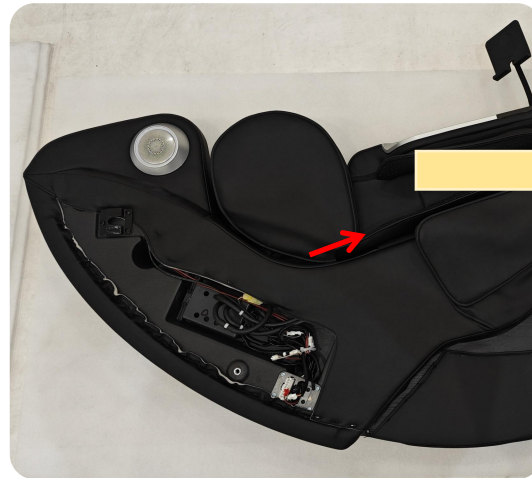

② Unzip the airbag

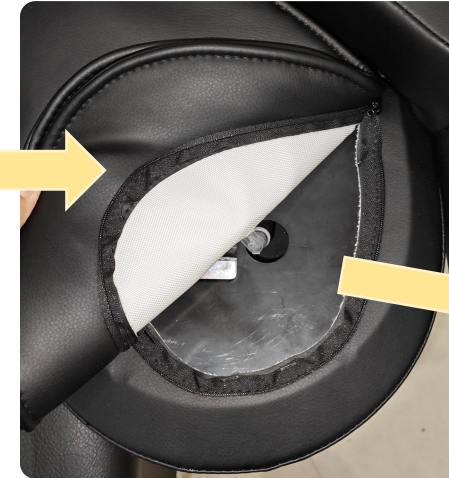

③ Remove the outer cover assy of the left shoulder with a tool

3. 4. 1 • Disassemble the armrest

Disassembly of the decorative part on the left armrest



Left shoulder outer cover assy

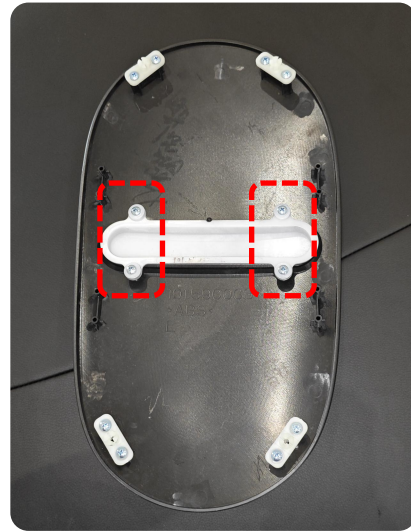

screw type

④ Remove the screws



Left shoulder outer cover



Lamp cover

3. 4. 1 • Disassemble the armrest

Disassembly of the decorative part on the left armrest

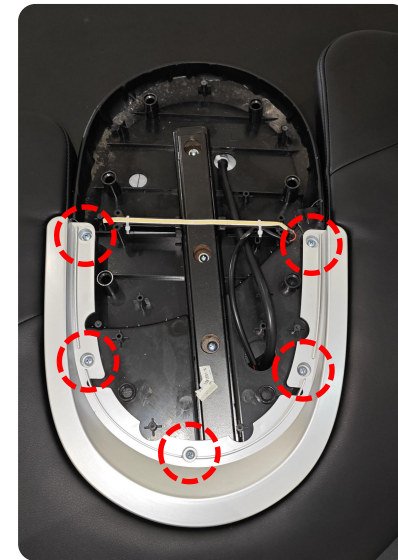
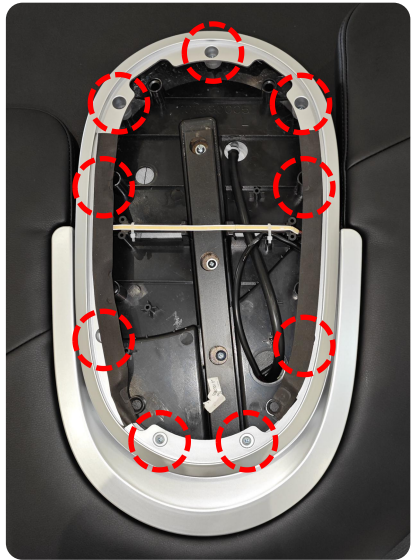

screw
type

⑤ Remove the screws



Left shoulder decorative ring

⑥ Remove the screws

U sharp decorative part

3. 4. 1 • Disassemble the armrest

Disassembly of the decorative part on the left armrest

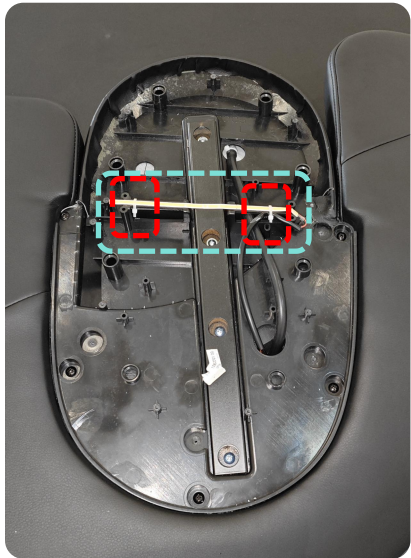

⑦ Cut off the fixing cable ties

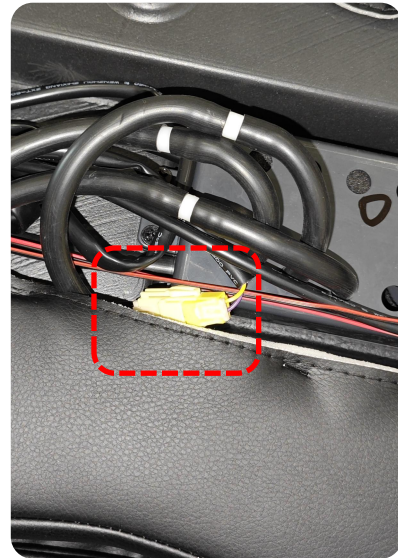

⑧ Unplug the connection terminals

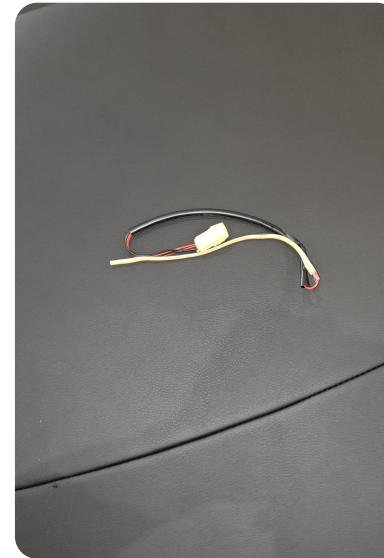

White LED strip

3. 5. 1 • Disassembly of the backrest



① Remove the backrest, air pipe & wiring harness

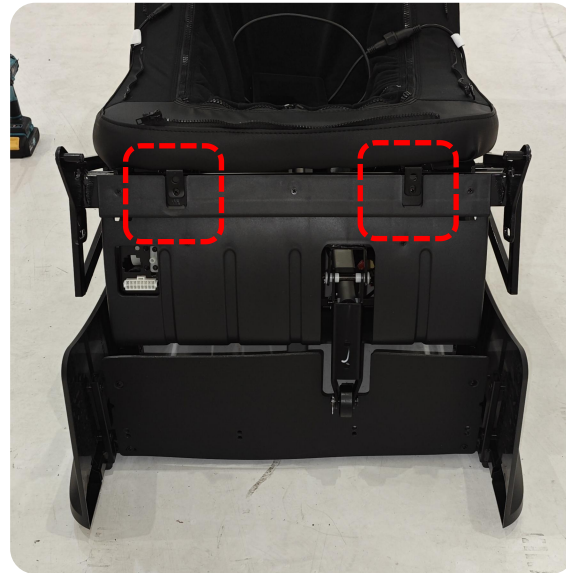

② Remove 2 pcs screws at the front end



③ Remove 4pcs screws on the back



Backrest assy

3. 6. 1 • Disassembly of the mechanism

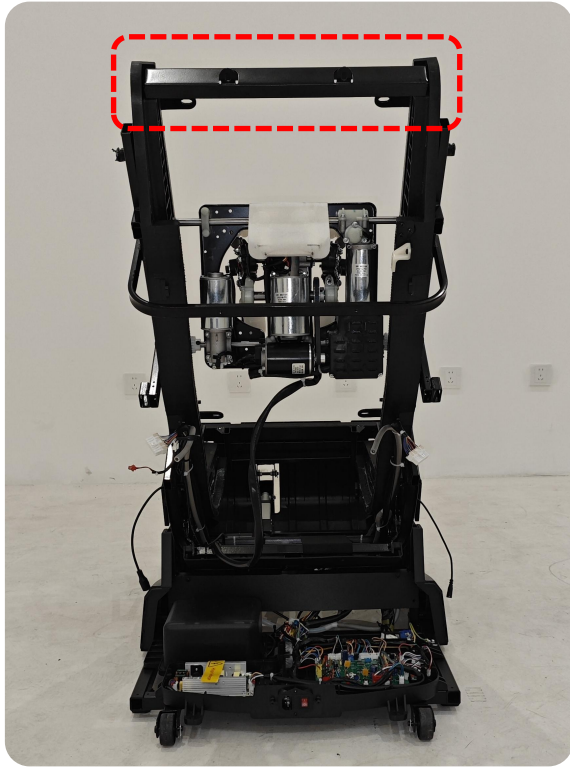

screw
type

Iron frame
crossbeam



① Remove the mech, the iron frame crossbeam & the screws on both sides

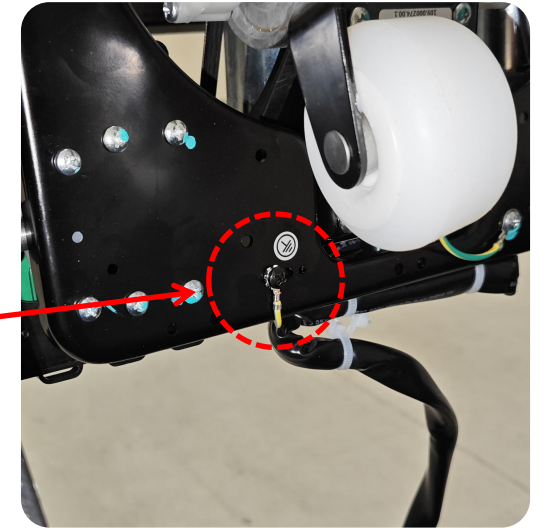
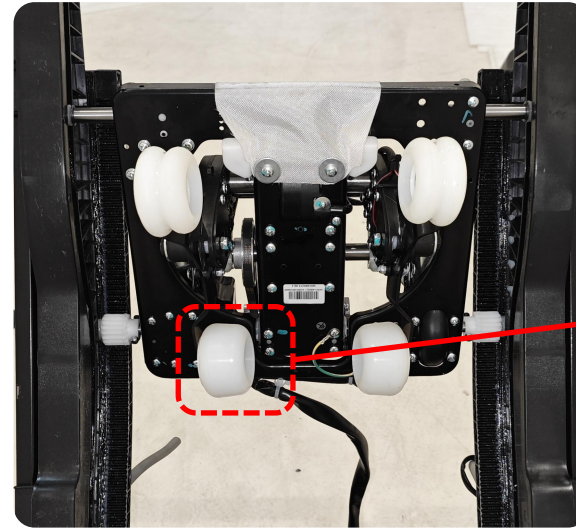

② Remove the screws that fix the ground wire

3. 6. 1 • Disassembly of the mechanism



③ Remove the induction magnet

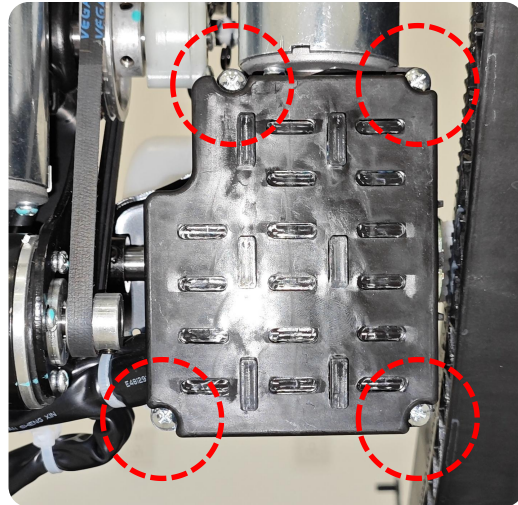

④ Remove the screws & take off the wire harness cover plate

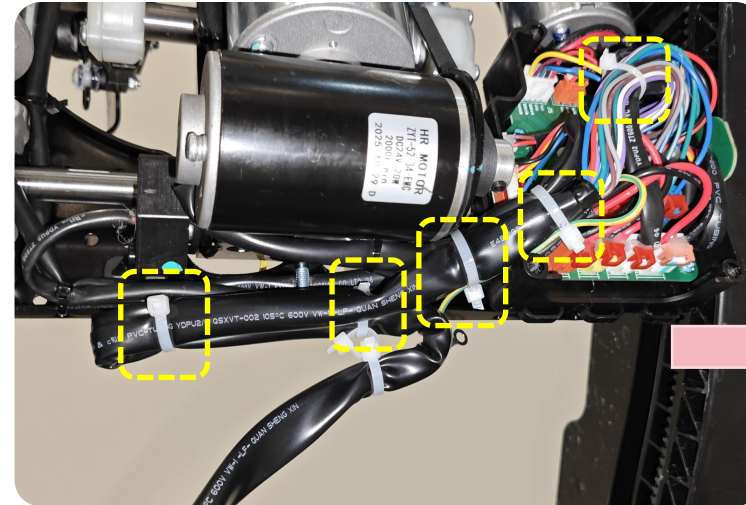

⑤ Cut off the cable ties



3.6.1 • 机芯的拆卸

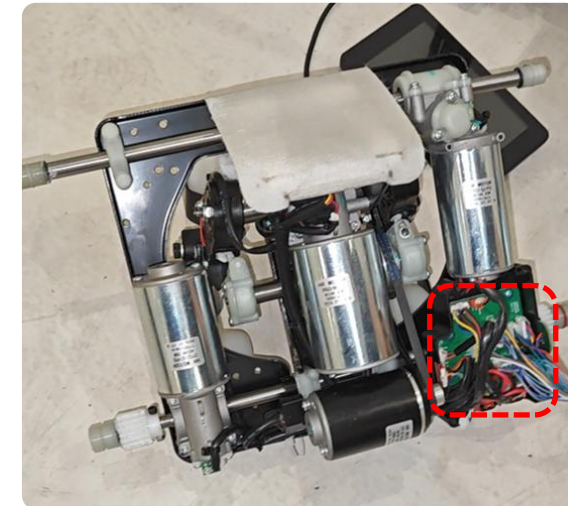
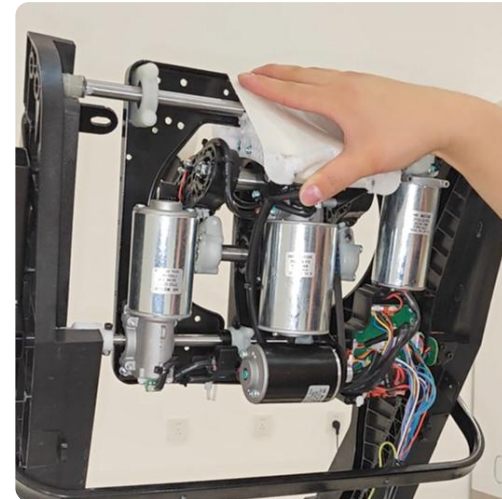

- (1) Power on, then turn on the tablet.
- (2) Click "MANUAL", "ACTION" Choose any mode from the options.
- (3) Click "POSITION", and then click "FIXED POINT"
- (4) Press and hold the "UP" button for a long time. The mech will move upwards until it hits the top (please hold the mech with your hand to prevent it from hitting the top and falling).

⑥ Remove the mech

⑦ Unplug the connection terminals

3. 6. 1 • Disassembly of the mechanism

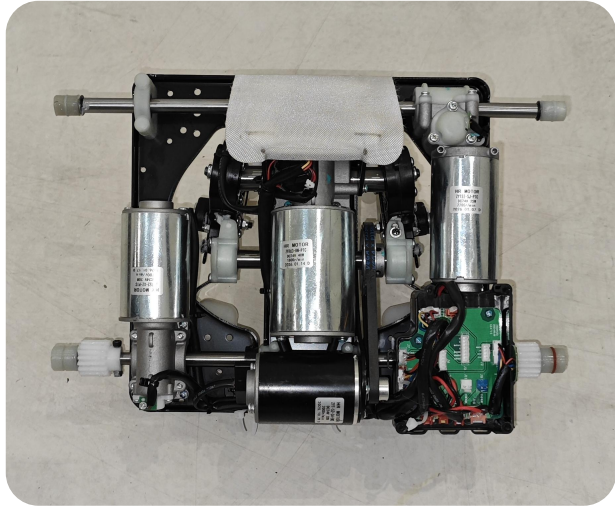

Mech

3. 7. 1 • Disassembly of the power box

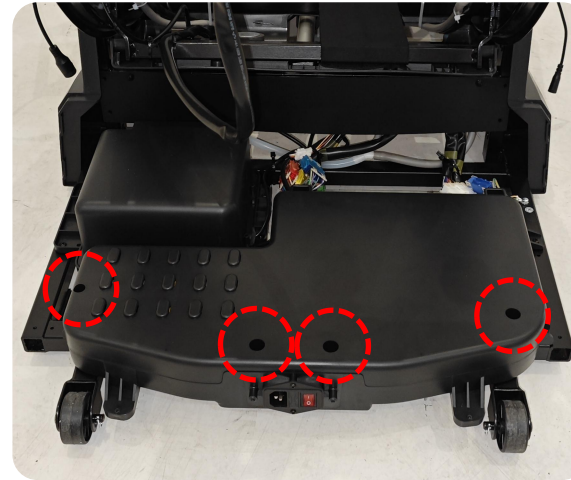
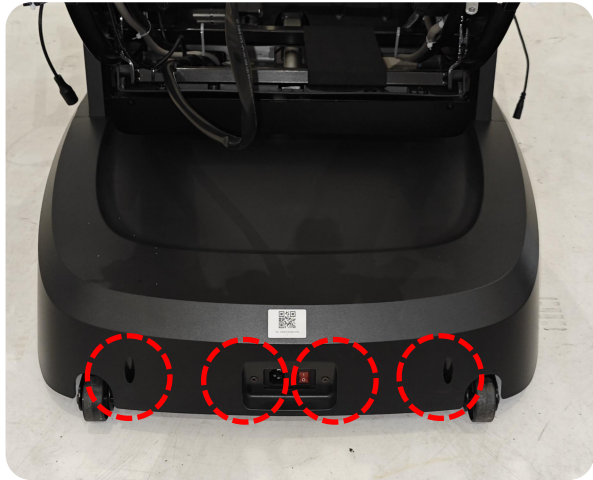

① Remove the screws

The outer cover of the power box

② Remove the screws

The upper cover

3. 7. 1 • Disassembly of the power box

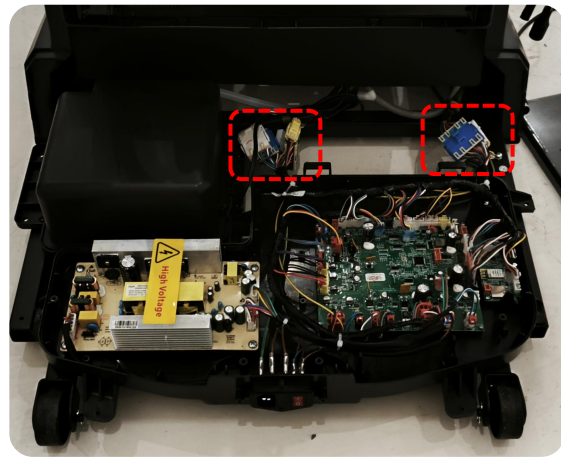

③ Unplug the connecting air pipe and the terminal

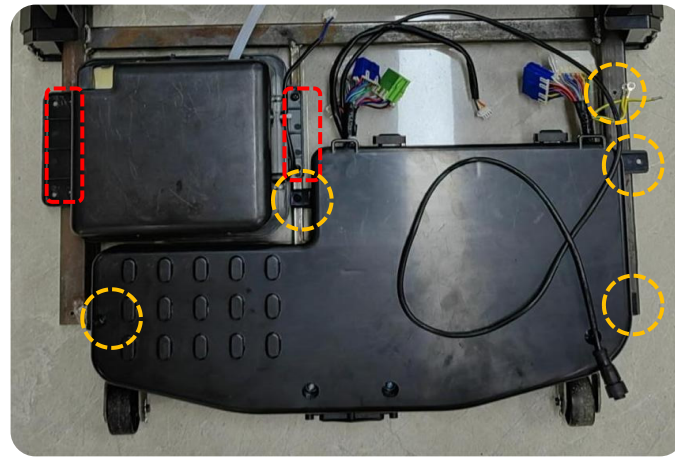

④ Remove the screws



Power box
assy



Air pump
box

3. 8. 1 • Disassembly of the side panel

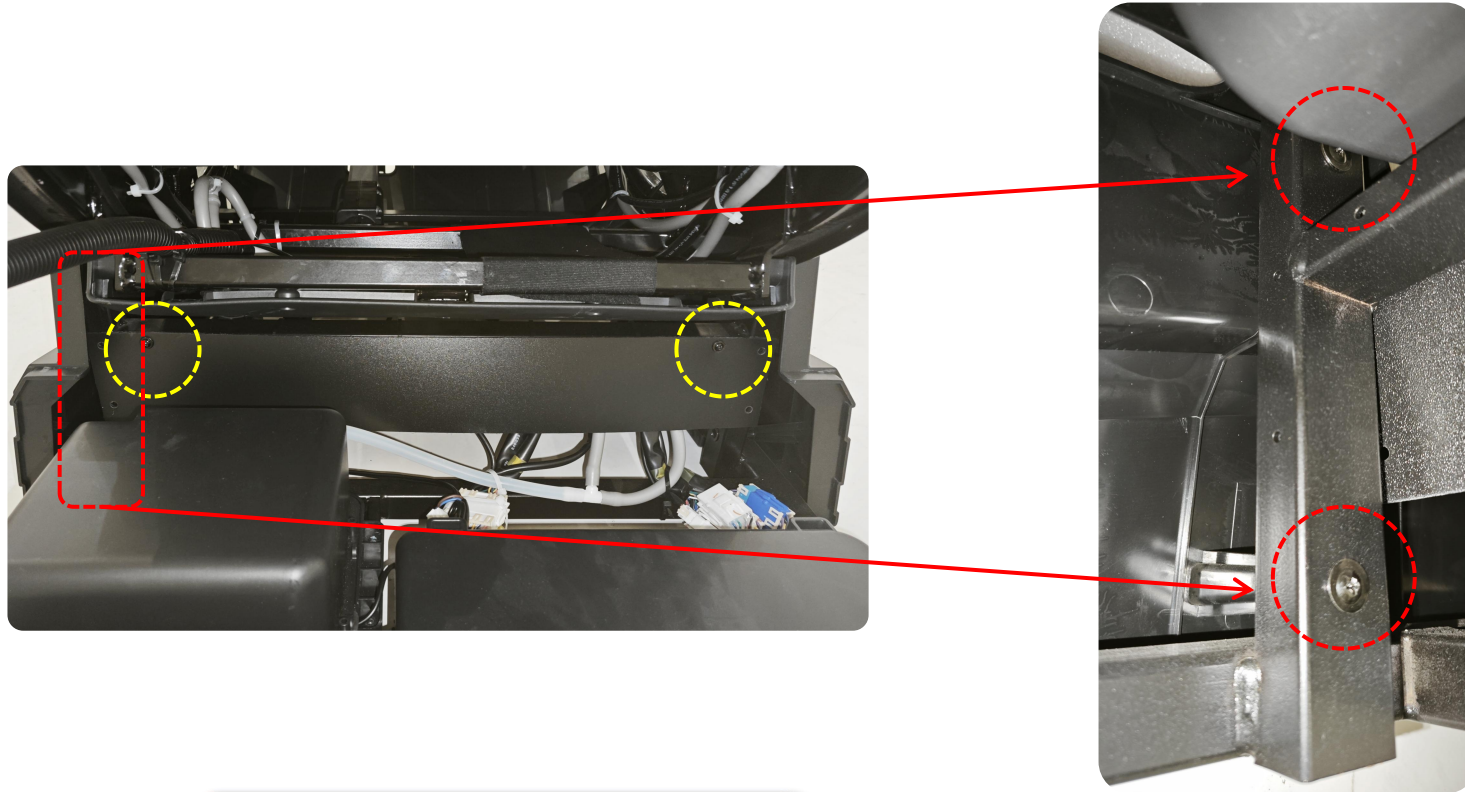

① Remove the screws of the rear panel & the rear side panel

3. 8. 1 • Disassembly of the side panel

F

M

B

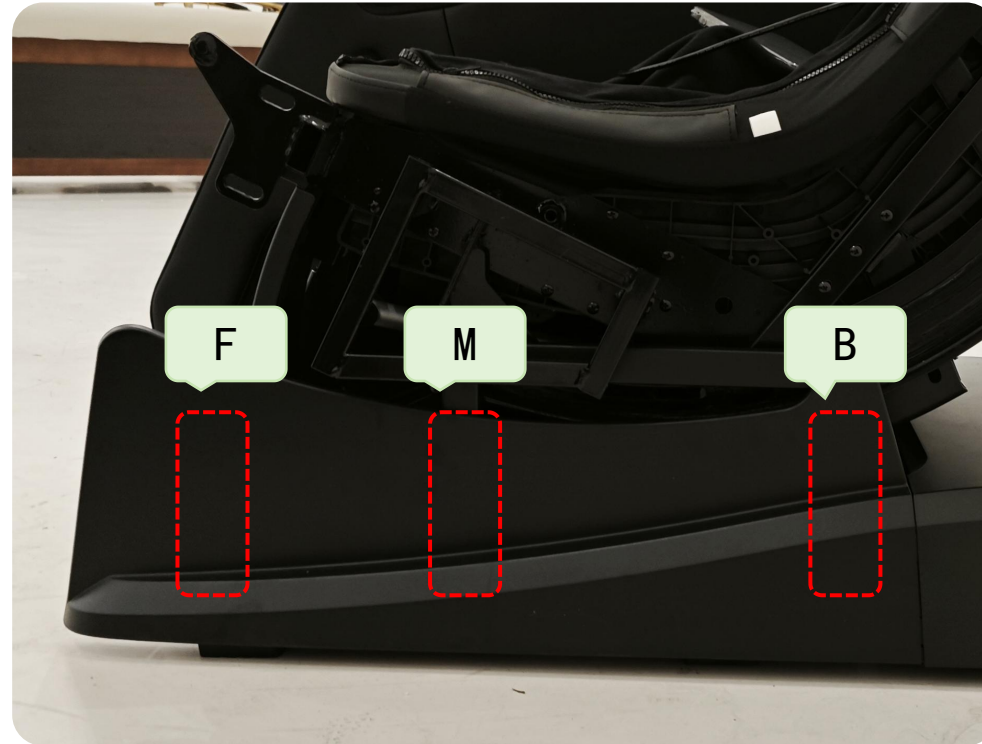
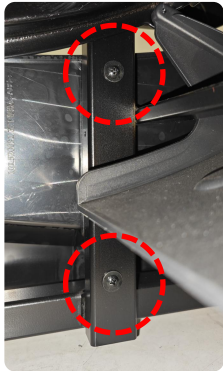
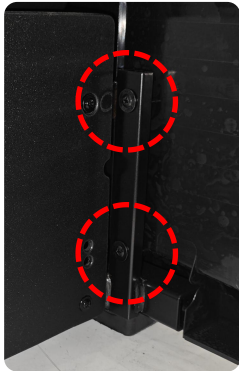

screw
type



① Remove
the screws

Lower left
side panel

3.9.1 • Disassembly of the actuator

**Disassemble the
footrest actuator**

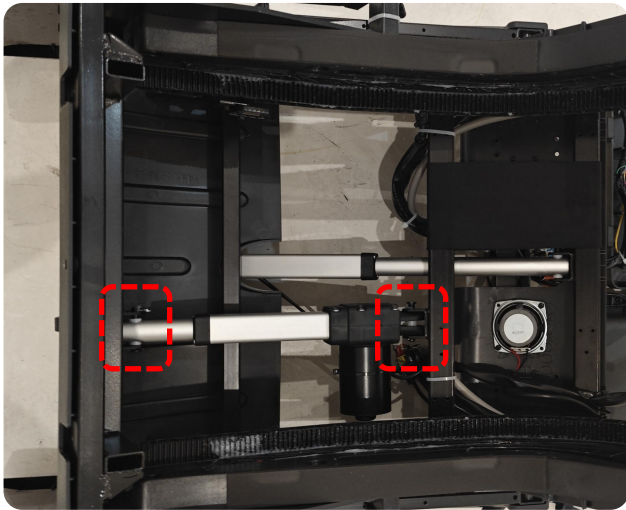

① Remove the fixed pins at both ends of the actuator

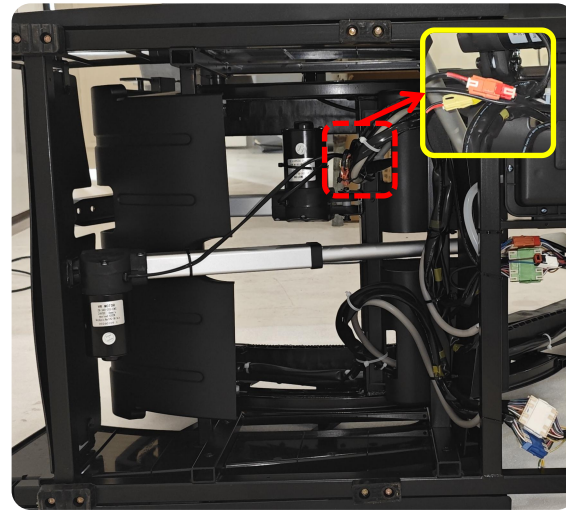

② Place the chair sideways, cut off the fixing cable ties & unplug the connection terminals



Footrest
actuator

3. 9. 1 • Disassembly of the actuator

Disassembly of the backrest actuator

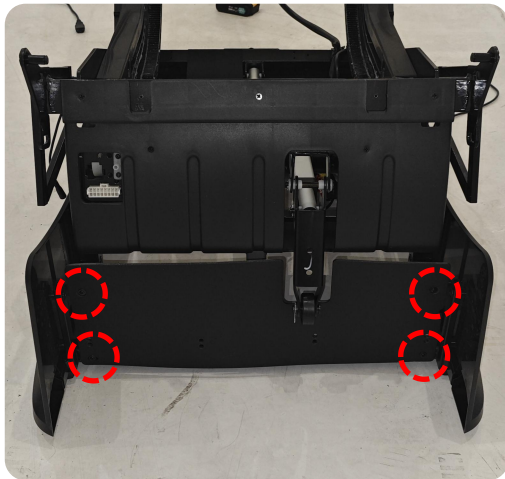

① Remove the screws & take off the front baffle

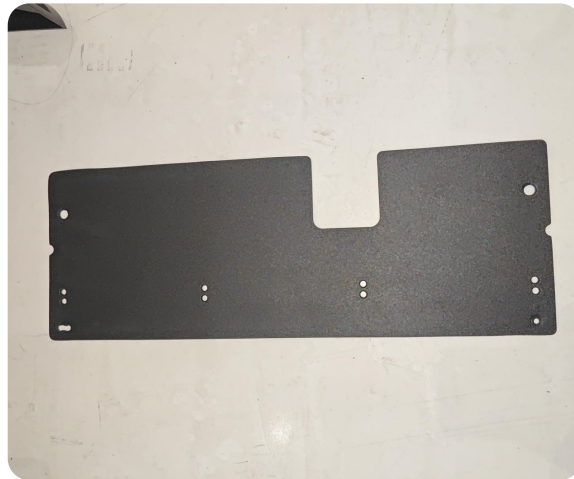

Front baffle



② Remove the fixing pin of the actuator

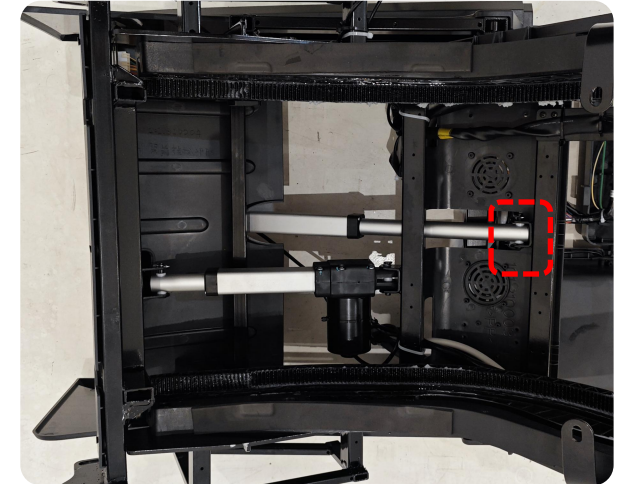

③ Remove the fixing pin of the actuator

3. 9. 1 • Disassembly of the actuator

Disassembly of the backrest actuator

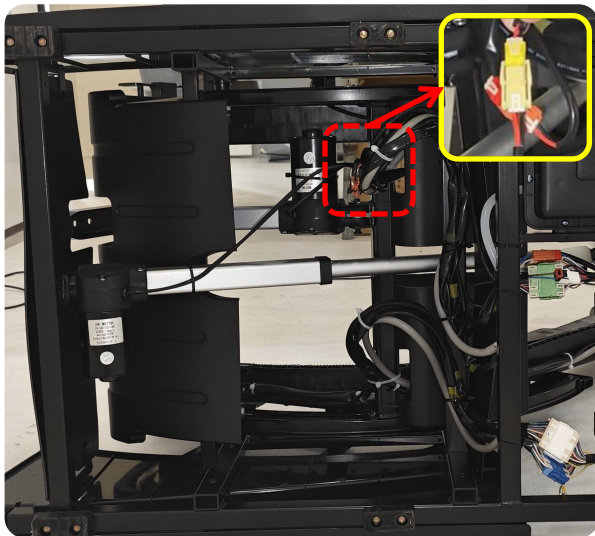

④ Place the chair sideways, cut off the cable ties & unplug the connection terminals

Backrest actuator

4. Analysis and Repair of Massage Chair Faults



1. The whole chair is not working.
2. Kneading and Knocking do not work.
3. The mech cannot move up and down.
4. The backrest or the footrest actuator does not rise or down.
5. The roller of the foot do not work.
6. The backrest or foot heat therapy doesn't work.
7. No music function.
8. A certain group of air pressures is not working.

4. 1. 1 • Analysis and Repair of Massage Chair Faults

The whole chair is not working

1.The tablet is damaged,can't start up. The method of replacing the tablet is adopted.(Pic1)

①



Analysis

2. Check if the main switch is on and inspect if the fuse is blown. Generally, it is caused by a short circuit in the main PCB or power switch board. Replace the main PCB & fuse (Pic2)

②

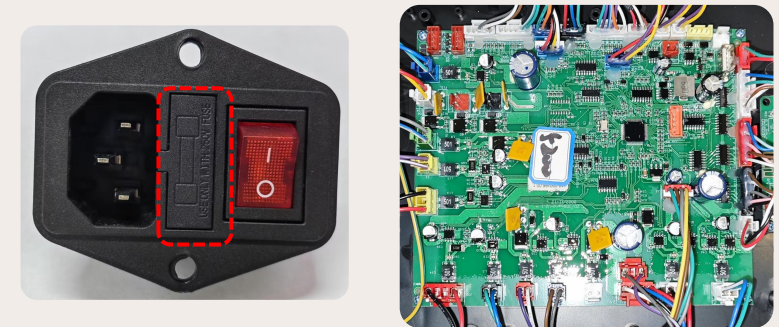

3.Check the power board to see if there is a 120V input & a 5V output.Replace the power board if there is no 5V voltage, & replace the main board(Pic3)

③



4. 2. 1 • Analysis and Repair of Massage Chair Faults

Kneading and Knocking do not work.

Analysis

1. First, check if there is poor contact in each harness plug-in from the PCB to the kneading motor and whether there is voltage output(Pic1)

2. Remove the back cover and measure if there is voltage in the plug on the back cover of the mech(Pic2). If there is voltage, it indicates that the motor is damaged. There is no problem with the voltage harness or the board type.

3. In the absence of a multimeter, the condition of the motor can be confirmed by substitution (by interchanging the kneading and knocking plugs).

①

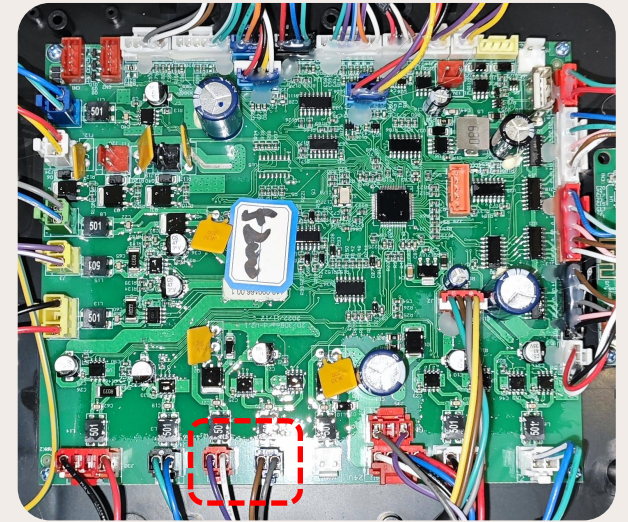

②

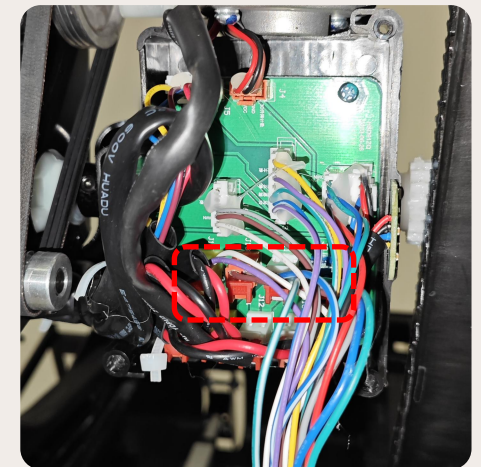

4. 3. 1 • Analysis and Repair of Massage Chair Faults

The mech can't move up and down.

Analysis

1. First confirm and check whether there is any poor link or loose plug-in in the harness.
2. To determine whether a motor is damaged, you can use tapping the power supply of the motor to judge its condition (Pic1).
3. Determine whether the upper and lower limit detection plates are damaged or whether the upper and lower magnets have fallen(Pic 2)
4. In the absence of a multimeter, the condition of the motor can be confirmed by substitution (by interchanging the walking and kneading or tapping plug).
5. Measure whether there is an AC24V output at the PCB terminals and whether the PCB is damaged (Pic3).

①

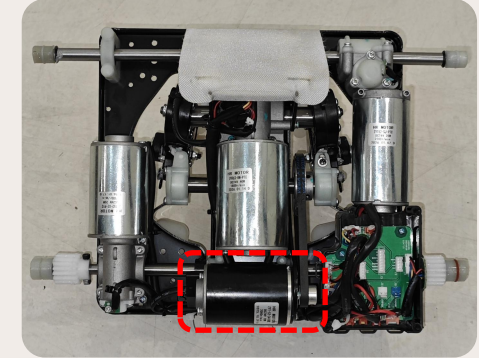

②



③

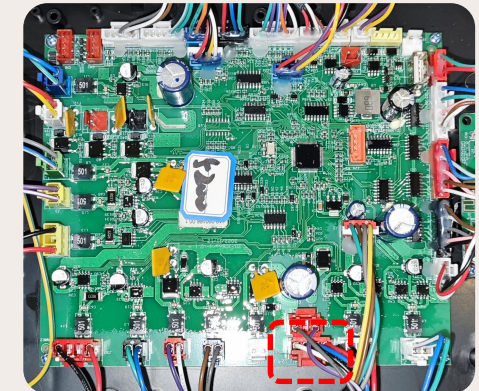

4. 4. 1 • Analysis and Repair of Massage Chair Faults

The backrest or the footrest actuator does not rise or down.

1. Check whether there is poor link at the harness terminals from the PCB to the actuator (Pic1)

①



Analysis

2. Use a multimeter to measure whether there is voltage output from the PCB. If there is no voltage output, replace the PCB (Pic2).

②

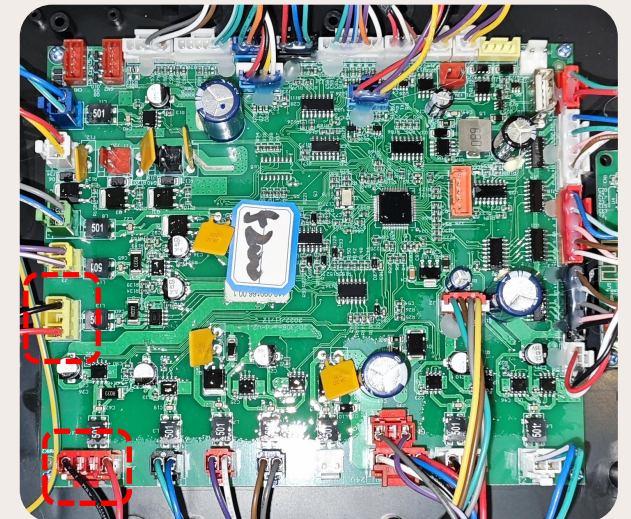

3. First, hold down the actuator lying button and listen to the "beep, beep," sound from the tablet. Then check if the chair moves up or down to determine if the actuator is faulty and replace it.

4. 5. 1 • Analysis and Repair of Massage Chair Faults

The roller of the foot do not work.

Analysis

1. First,check if there is any poor link or loose plug-in in the wiring harness.(Pic 1)

2. Use a multimeter to measure whether there is a DC24V at the terminal (Pic 1).If there is no voltage,it indicates that the PCB and harness are damaged and need to be replaced.If there is voltage,it indicates an internal fault in the leg.

3. Disassemble the leg to check if the terminals of the harness have come off.If they have, just reinsert them properly (Pic2).

4. If the foot adapter is in good condition and the harness is normal,it can be determined that the roller motor is damaged and needs to be replaced (Pic 3).

①



②

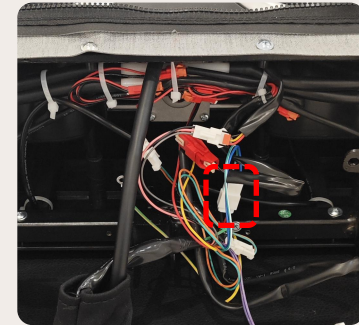

③

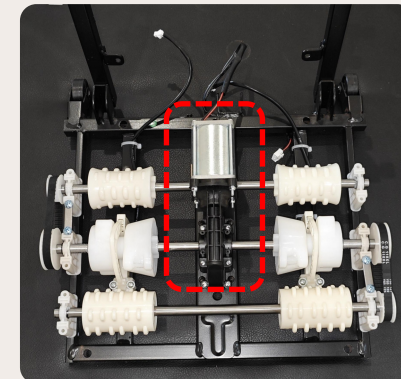

4. 6. 1 • Analysis and Repair of Massage Chair Faults

The backrest or foot heat therapy doesn't work.

①

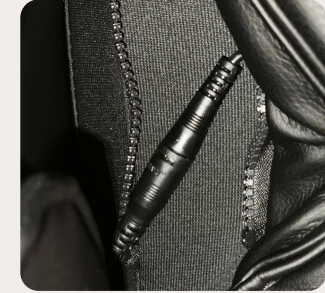

1. Check if there is poor link or detachment at the terminal of the heating wire on the backrest (Pic 1)

②

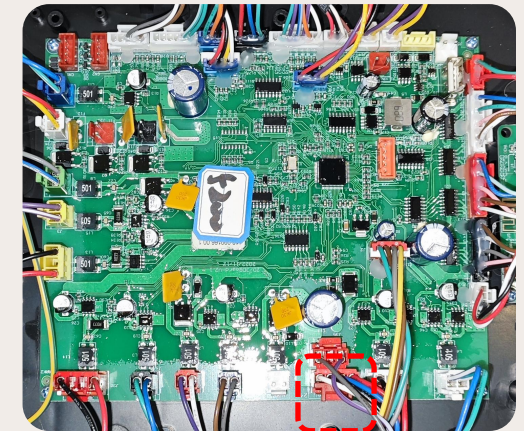

Analysis

2. Use a multimeter to measure whether there is AC24V at the terminals of the PCB. If there is damage to the PCB, replace it (Pic 2)

③

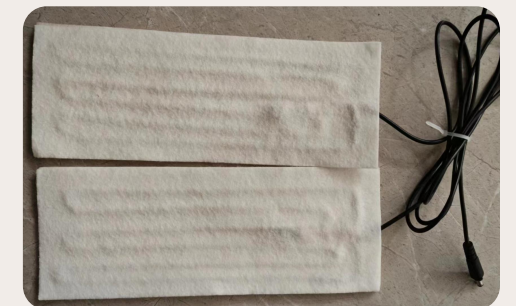

3. Use a multimeter to measure whether there is AC24V at the terminals of the PCB. If there is a voltage output, check the harness. If the communication of the harness is normal, replace the heating plate (Pic 3)

4. 7. 1 • Analysis and Repair of Massage Chair Faults

No music function

Analysis

1. Phones can't find the bluetooth name after the chair on:
A. check that the tablet bluetooth switch is on (Pic 1)
B. to turn off the power to search again after waiting for 3 to 5 minutes, still can't search to replace the bluetooth PCB.

2. Phone is successfully paired with bluetooth. Check whether the contact of the bluetooth PCB harness is normal. If not, replace the bluetooth PCB (Pic 2)

3. Check whether the cable from the Bluetooth PCB to the speaker is in poor link.

4. If one side of the speaker does not sound, check the harness and replace the speaker (Pic 3)

①

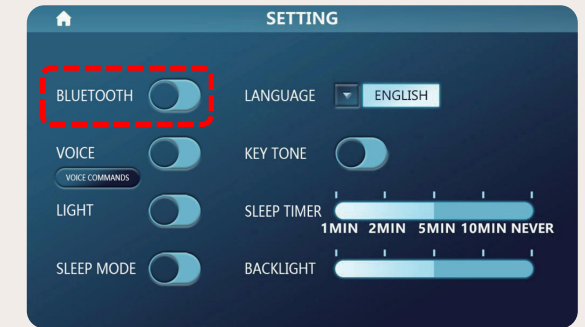

②

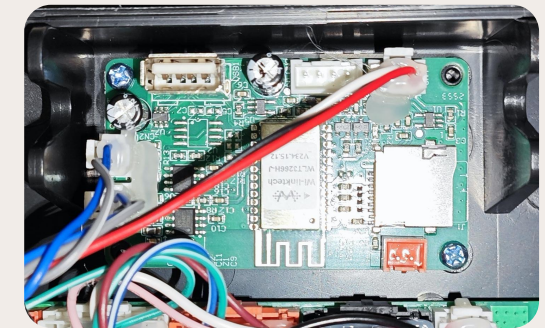

③



4. 8. 1 • Analysis and Repair of Massage Chair Faults

A certain group of air pressures is not working

①

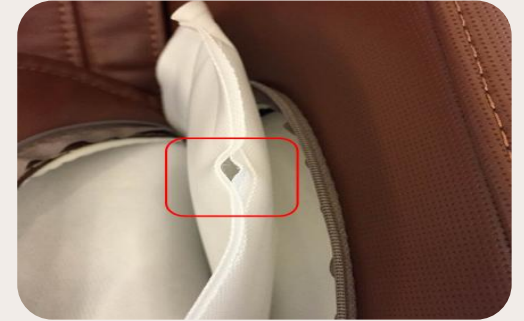

1. Check whether the air bag of this way is cracked and whether the air pipe is bent (Pic 1)

②

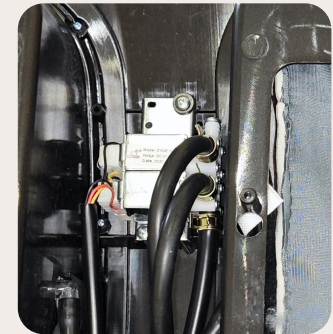

2. Check whether the air valve controlling the air pressure of this circuit is damaged (Pic 2)

③

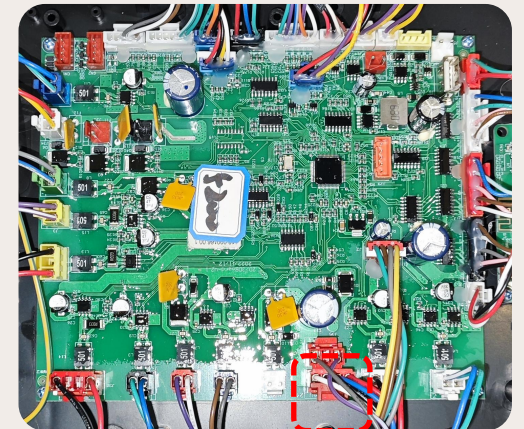

3. Use a multimeter to measure whether the terminal voltage of the PCB is output. If there is no voltage output, replace the PCB (Pic 3)

Analysis

5.Tool list

							
Multimeter	Test pen	Hex wrench	Nipper pliers	Rubber tape	Cable tie	Vice jaw	Electric drill



Thank you

Service dept