RK7909BA

Jupiter Premium LE

Service Manual



Shandong Kangtai Intelligent Technology Co., Ltd

Foreword

Thank you for choosing Rongkang massage chairs!

It is our greatest honor that you are the client of Shandong Kangtai Intelligent Technology Co., Ltd. We sincerely hope that Rongkang massage chairs can become your good assistant for leisure and health.

To facilitate on-site maintenance of the products by our dealers and customer service personnel, we have compiled some common problems and solutions encountered during the use of massage chairs for professional repair personnel to refer to.

Note: Do not attempt this if you are not a professional.

After Sales Service: (86) 400 -6582511

(86) 0535 -8243907

(86) 0535 -8243916

<http://www.kangtaigroup.com>

Contents

I Product Structure	1
1.RK7909BA Structure Chart	1
2.Key Parts:	3
II Fault and Solution	5
1. Massage chair not work, No Remote Display	5
2. Fuse fault	6
3. Actuator Fault	6
4. Footroller Fault	8
5. Air Pressure Fault	8
6. Roller not Moving Up&Down	10
7. Roller stuck at bottom or top	11
8. Position masage, roller run whole section	12
9. Shoulder height detection fault	12
10. Kneading fault	13
11. Tapping Fault	14
12. Roller Width, middle, narrow fault	15
13. Roller heating Fault	16
14. Leg heating Fault	16
15. Seat, Whist heating Fault	17
16. Controller Display Fault	17
17. Horn Fault, Voice Fault	17

III Mechanical Fault and Solution:	19
1. Replace up&down motor	19
2. Replace Mechanism	20
3. Replace Air pump	22
4. Repace Solenoid Valve	23
5. Replace Leg Acuator	25
6. Replace Forward Sliding Acuator	25
7. Replace Foot Roller	26
IV System Chart	29

I Product Structure :

1.RK7909BA Structure Chart

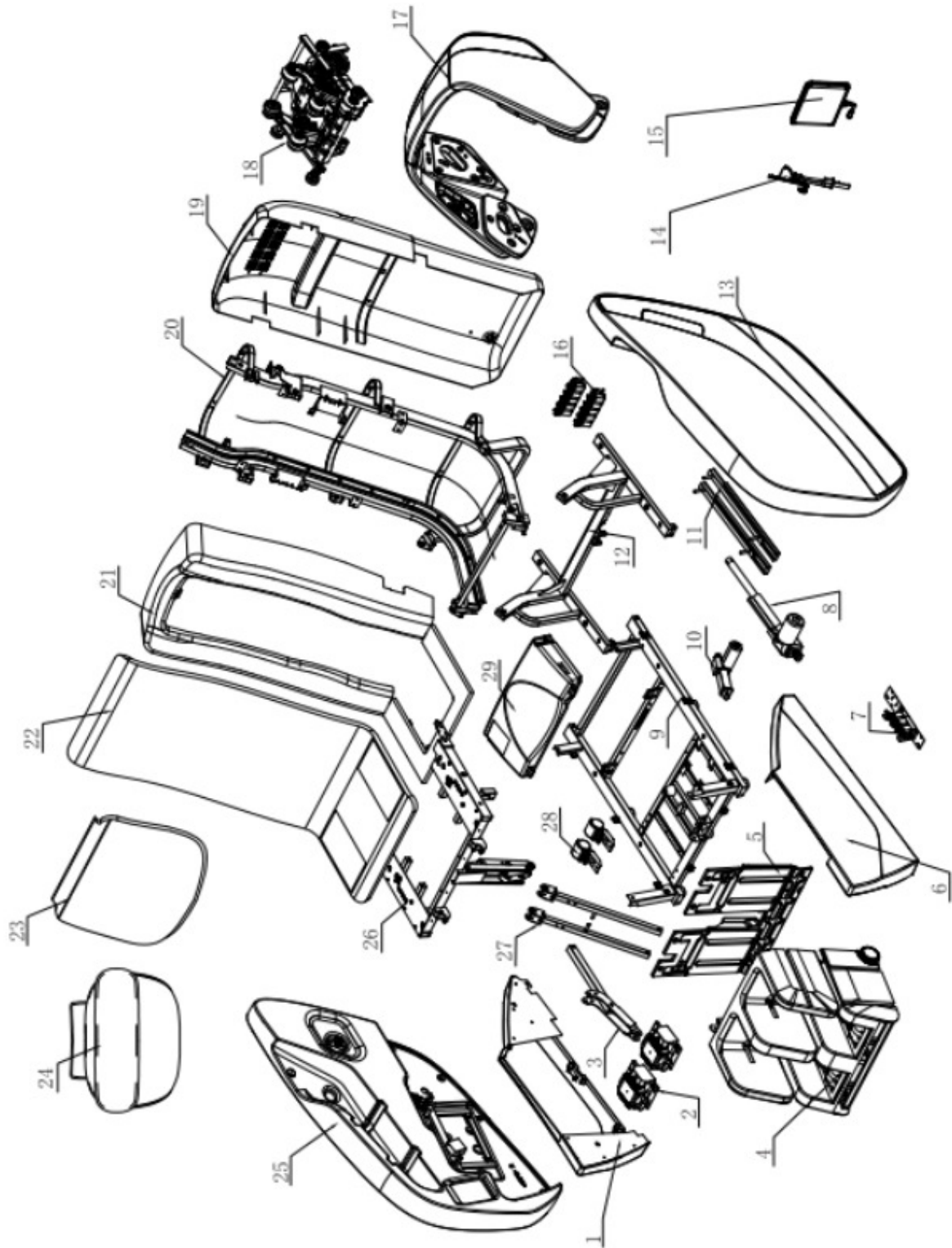

Mechanical components list

NO.	Name	Q' ty	NO.	Name	Q' ty
1	Right side fender	1	22	Back and seat cushion	1
2	Air pump assembly	2	23	Shoulder pads	1
3	connecting rod	1	24	Pillow	1
4	Legrest & footrest	1	25	Right armrest assembly	1
5	Front fender	1	26	Seat frame surface assembly	1
6	Left side fender	1	27	Seat support bar	1
7	Electric magnetic valve	1	28	Castor	2
8	Backrest electric actuator	1	29	Power case assembly	1
9	Bottom seat frame assembly	1			
10	Footrest electric actuator	1			
11	Sliding rail	2			
12	Top seat frame assembly	1			
13	Left amrest assembly	1			
14	Tablet bracket	1			
15	Tablet remote control	1			
16	Electric magnetic valve	2			
17	Shoulder massage device	1			
18	Massage machine	1			
19	Back cover assembly	1			
20	Back frame assembly	1			
21	Backrest plastic front cover and seat plate assembly	1			

2.Key Parts

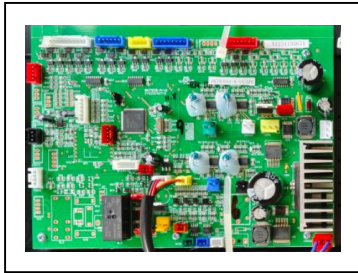

PCB



Electric PCB



Controller

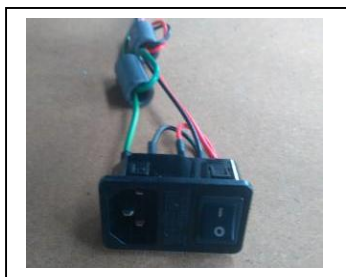

3in1 Switch

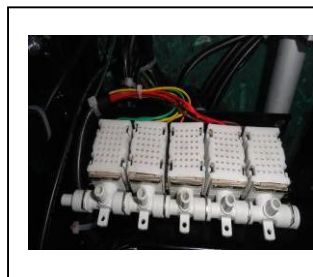

Solenoid Valve

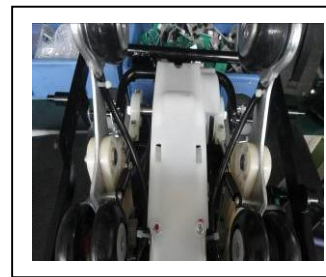

Roller



Back Actuator



Leg Actuator

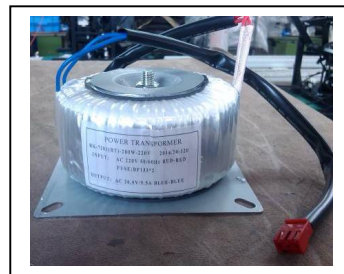

Transformer



Air pump

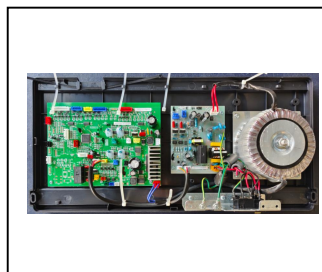

Control Box

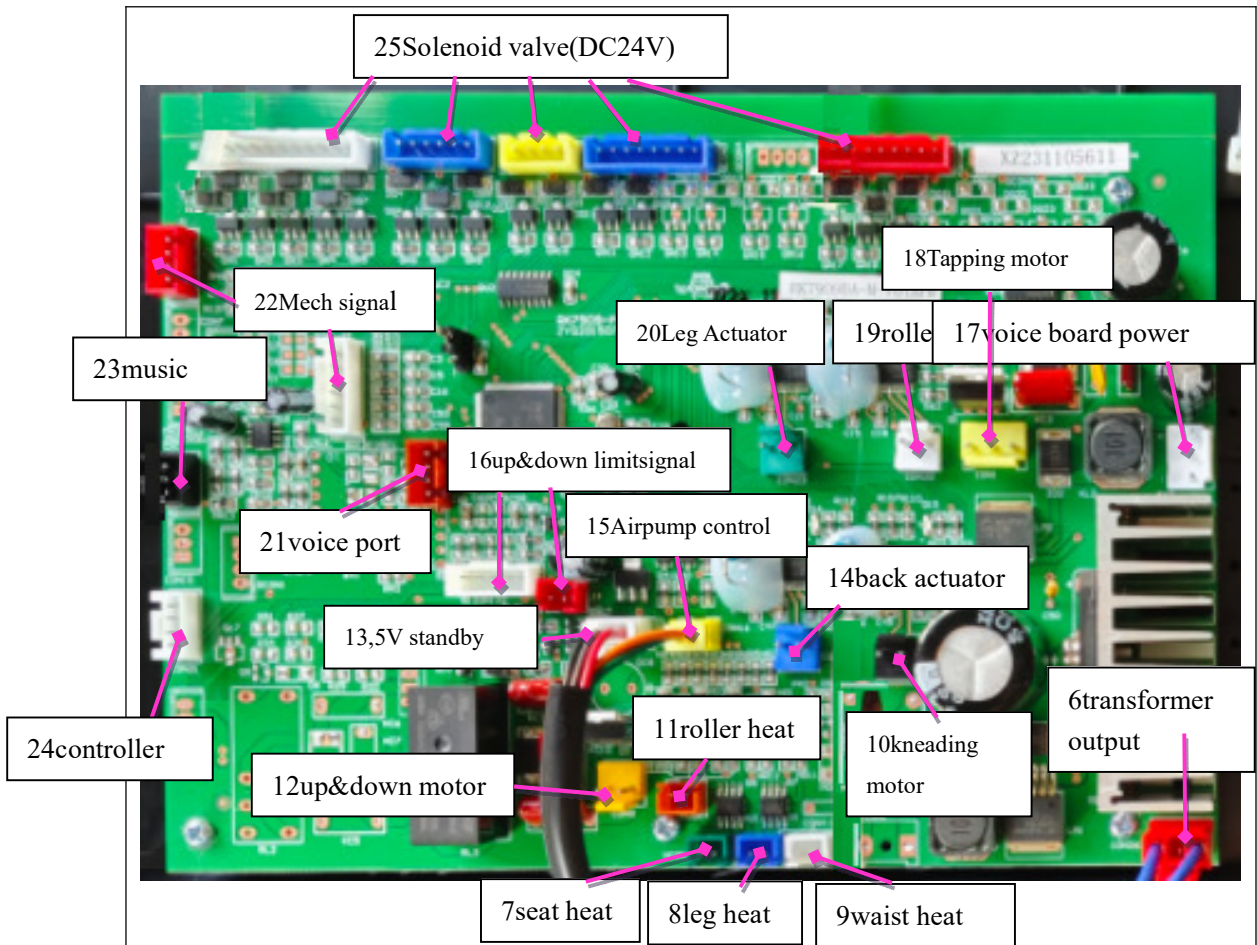

PCB Connection

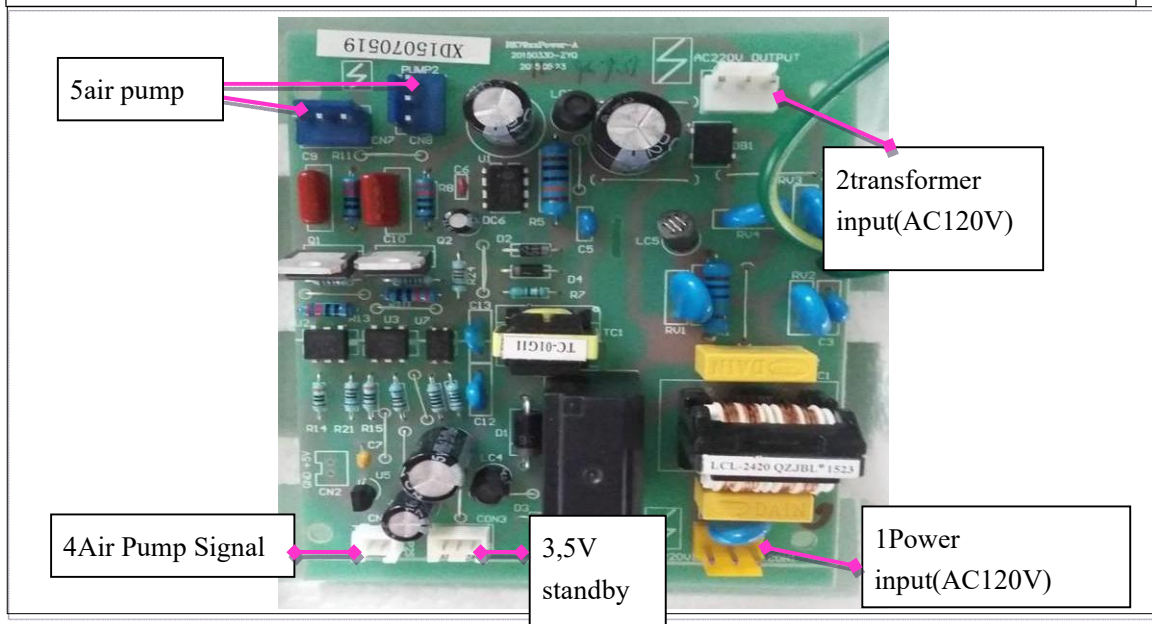

Power PCB Connection

II Fault and Solutions

1. Massage chair not working, No display on remote

1.1 Check that socket has power. Turn on the 3-in-1 switch and check if the fuse of the 3-in-1 switch is blown. If the fuse is blown, replace it and it will work normally.

1.2 Use a multimeter in AC voltage mode to measure the voltage at connector 2 on power board and connector 6 on main board. If there is 120V at connector 2 and no 20.5V output at connector 6, the transformer is faulty and needs to be replaced.

1.3 Use a multimeter in AC mode to measure if there is AC120V voltage at point 1. If not, replace the 3-in-1 switch wiring harness. If there is voltage, use a multimeter in DC mode to measure whether the voltage at connector 3 (white) (DC 5V) on the power board is normal. If there is voltage, check whether the connection between power board and main board is good. If there is no problem, turn the power on and off and measure whether there is a high or low level change between the brown and black wires. If there is no change, replace the main board; otherwise, replace the power board.

1.4 Check that remote cable aviation plug is securely connected and that it is firmly inserted into the connector on the circuit board. If both are normal, measure if there is DC 5V voltage at both ends of

NO. 24 connector. If there is voltage, replace the remote; if there is no voltage, the main board is the problem. If all measurements are normal but the problem persists, replace either the remote or the main board.

2.Fuse Blowing After Power-On

2.1 Fuse blowing after power-on: Symptoms and Troubleshooting:

2.1.1 First, check for short circuits in the functional motors (e.g., tapping, kneading, walking, and electric support rods), connector wires, and main board electronic components. If any are found, replace them to resolve the problem.

2.1.2 Measure power input line for short circuits. If any are found, disconnect all connectors and check each one individually to identify the short circuit. Replace the shorted component.

3.Actuator Failure (Actuator Not Working)

3.1 Determine if the problem is with the mainboard or actuator itself.

3.1.1 Swap the malfunctioning actuator connector with another actuator connector (leading from the main board). If it still doesn't work after the swap, the actuator is damaged; replacing it will resolve the problem.

3.1.2 If actuator works after the swap, main board is damaged;

replacing main board will resolve the problem.

3.2 How to Determine the Quality of an actuator

3.2.1 After checking that the actuator extension cable is working properly, set a multimeter to DC voltage mode. Insert the two probes into the actuator connector terminals and operate the hand controller's lowering/raising leg button. Check if the multimeter outputs 24V. If it does, the support strut is faulty; if not, the main board is faulty.

3.2.2 If the actuator is at its upper or lower limit, use a multimeter in diode mode to measure the connection wires. Interchange the red and black probes when measuring. If a unidirectional diode reading (around 0.5 ohms) is obtained, the actuator is fine; otherwise, it is faulty. If the actuator is not at either of its extreme positions, use a multimeter in resistance mode to check the connection wires. If there is no resistance or the resistance is too high between the two wires, the actuator motor is open-circuited (normally around 5-30 ohms). Replacing the actuator will resolve the problem.

4. Foot rollers not working

4.1 Turn on foot roller function and use a multimeter in DC voltage mode to measure the voltage at point 19 to see if it is 24V. If the

main board does not output 24V, the main board is faulty; if there is voltage output, check the continuity of the wiring harness between the rollers and the secure connection of the connectors. If they are normal, the roller motor is faulty and needs to be replaced.

5.Air Pressure Function Failure

5.1 Air Pump Not Working:

5.1.1 Check if air pump power cord and connector (CN7-8) at point 5 on the power board are in good condition.

5.1.2 Turn on the air pressure function. Check if air pump wiring harness connection and continuity between the power board and the main board are normal. If abnormal, replace the wiring harness.

Use a DC voltage meter to measure the voltage between pins 1 and 2 and ground at each of the four points. If the voltage is always high, the main board is faulty and needs to be replaced. Use a multimeter to measure if there is 120V voltage at connector (CN7-8) at point 5 on the power board. If there is voltage, check the wiring harness and connector connection between the air pump and the main board. If abnormal, replace the wiring harness. If normal, the air pump is faulty and needs to be replaced. If there is no voltage output, the power board is faulty and needs to be replaced.

5.2 Air pressure drops after air pump has been working for a period of time:

5.2.1 Check if air pump inlet is dirty or blocked, and clean it thoroughly.

5.2.2 Check if the main air hose is bent, loose, or leaking. Secure or replace the hose if necessary.

5.3 The air pump is working normally, but the air bladder does not inflate.

Port Correspondence Table (Total 14 Solenoid Valves)

Foot	leg				arm	arm									
side	back	Leg 4	Right	Right	left	left	shoulder	3D	3D	Left	left	arm	arm		
4 air	2 air	airbag	hip	waist	front	back		mech	mech	hip	waist	right	right	pillow	
bag	bag											front	back		

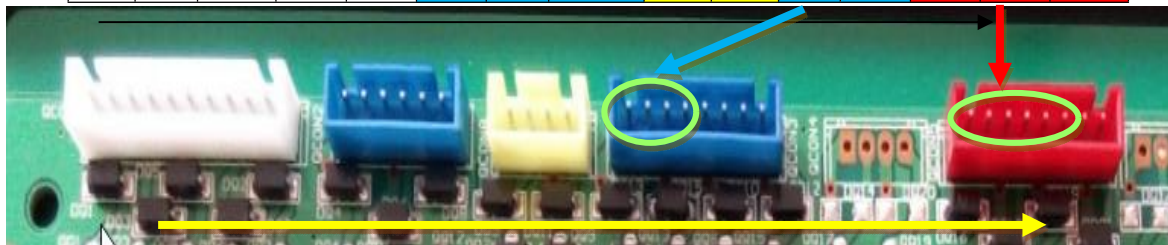

Solenoid valve drive

5.3.1 Check air pump and solenoid valve for any loose, disconnected, or damaged air hoses. Check the solenoid valve's inlet and outlet for blockages. If any are found, reconnect or replace them.

5.3.2 Check the solenoid valve drive section for open circuits and damaged components (as shown in the diagram above). If any are found, replace the main board. Check if the main board's solenoid

valve port has a DC 24V voltage output. If not, the main board is faulty and needs replacement.

5.3.3 Check the solenoid valve If there is damage.

Checking method: Set a multimeter to resistance mode and measure the resistance (approximately 165Ω). If the displayed resistance is infinite or very low, the solenoid valve is faulty and needs replacement.

6 Massage Mechanism not lifting/lowering:

6.1 With manual kneading or tapping activated, the mechanism should be in lifting/lowering mode. Check if there is DC 24V output at connector CON9 (orange) on the main board of the lifting motor port. If there is no voltage, the main board is faulty and needs replacement. If there is voltage output, check the continuity of the wiring harness between the motor and the connector connections. Replace the corresponding wiring harness assembly if any is faulty.

6.2 Check if the resistance of the lifting motor is normal (5Ω - 30Ω). If there is no resistance or the resistance is too high, the motor is damaged and needs replacement.

6.3 If there is voltage and the motor resistance is normal, touch the lifting motor casing to feel for vibration during operation. If there is vibration, the motor is stalled and the lifting transmission structure needs replacement.

7 Top/Bottom Mechanism Faults

7.1 Turn on the manual controller and select the manual kneading or striking function to operate the mechanism in both upward and downward motion. If top or bottom mechanism occurs, check if the magnet on the mechanism has fallen off. If the magnet is missing, replace and reassemble it.

7.2 Check if the upper and lower limit board connectors are loose. If not, use a multimeter in buzzer mode to check the continuity of the wiring harness between the main board and the limit board. If abnormal, replace the lifting and lowering limit wiring harness assembly.

7.3 Use a multimeter in DC voltage mode to measure the lifting and lowering limit signals at point 16 on the main board. Bring a magnet close to and away from the Hall effect sensor and observe if there is a change in high or low level. If there is no change in high or low level, replace the corresponding limit board; otherwise, replace the main board.

8 Zone Massage, Mechanism run whole stroke.

8.1 Check the lifting motor counter signal. Slowly rotate the lifting motor shaft by hand. Use a multimeter in DC voltage mode to measure the voltage difference between the brown and black

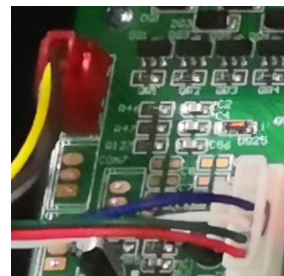

wires of the lifting counter connector in the mechanism signal. If there is a voltage change, replace the main board. Check if there is DC 5V voltage between the red and black wires. If not, replace the main board. (See diagram).

8.2 Check if the connector between the lifting motor and the counter is secure. Check the continuity of the lifting counter adapter harness. If it is not continuous, replace the lifting counter adapter harness. Otherwise, replace the lifting counter.

9 Shoulder Height Detection Malfunction

9.1 Power on and select a program. The mechanism will begin shoulder height detection. If the mechanism immediately reaches the upper limit, it indicates a shoulder height detection malfunction.

9.1.1 Check the mainboard, mechanism signal connectors, mechanism signal harness connectors, and connectors on the mechanism adapter board for poor or missing connections. Check if the magnet on the right rocker arm is detached, and if the shoulder height detection element is missing or damaged.

9.1.2 Use a multimeter in beep mode to measure the continuity of the wiring harness between the mainboard and the shoulder height detection element. If abnormal, replace the corresponding wiring harness assembly.

9.1.3 Use a multimeter in voltage mode to measure the voltage

between the yellow and black wires of the mechanism signal. Press and release the right roller arm to check for any voltage changes. If there is no voltage change, replace the shoulder height detection board assembly. Otherwise, replace the main board.

10.Kneading Malfunction

10.1Kneading Motor Not Working: Turn on remote and select manual kneading; check if there is DC24V output at connector CON24 (black) on the main board at port 10 of the kneading motor. If there is voltage output, check if the connector between the main board and the kneading motor is securely connected and if the wiring harness is continuous. If abnormal, replace the corresponding wiring harness assembly.

10.2 Disconnect the connector and use a multimeter in resistance mode to measure the resistance of the kneading motor to see if it is normal (5Ω - 30Ω). If there is no resistance or the resistance is too high, the motor is damaged and should be replaced. If there is no voltage, the main board is faulty and should be replaced.

10.3If the kneading function starts immediately upon powering on the massage chair and cannot be turned off via remote, the main board is faulty and needs to be replaced.

11. Knocking Function Malfunction

11.1 Knocking motor not working. Turn on remote and select the manual knocking function.

11.1.1 Check if there is 24V output at connector CON1 (yellow) on the main board at port 18 of the knocking motor. If there is voltage output, check if the connector between the main board and the knocking motor is securely connected and if the wiring harness is functioning correctly. If abnormal, replace the corresponding wiring harness assembly.

11.1.2 Disconnect the connector. Use a multimeter in resistance mode to measure the resistance of the knocking motor to check if it is normal (5Ω - 30Ω). If there is no resistance or the resistance is too high, the motor is damaged and should be replaced.

11.1.3 If there is no voltage, the main board is faulty and should be replaced.

11.2 If the knocking function starts immediately upon powering on the massage chair and cannot be turned off via the remote, the main board is faulty and needs to be replaced.

12. Abnormalities in the Wide, Medium, and Narrow of Mechanism

12.1 Power on and activate the tapping function. The motor will continuously knead when the wide, medium, or narrow is selected.

12.1.1 Check if the plastic gear opposite the wide, medium, and narrow circuit board on the rotating shaft is damaged. If damaged, replace and reassemble.

12.1.2 Use a multimeter in DC voltage mode to measure the voltage difference between pins 2, 3, and 4 of the wide, medium, and narrow connectors (white connector) on the main board (22-pin mechanism) and ground. If there is a voltage difference, the main board is faulty and needs replacement.

12.1.3 Check if the connectors are securely plugged in. Use a multimeter in beep mode to check the continuity of the wide, medium, and narrow detection harness. If there is no continuity, replace the entire detection harness assembly; otherwise, replace the wide, medium, and narrow detection board.

13.Abnormal Heating Function of the Massage Mechanism

13.1 Massage Mechanism Not Heating: Turn on the massage mechanism and turn on the heating element. Check if there is DC 24V output at connector 11 on the main board. If there is no voltage output, the main board is faulty and should be replaced.

13.2 Check if the connectors between the heating balls are securely connected and if the wiring harness is functioning correctly. Replace the corresponding wiring harness assembly if any is faulty.

13.3 Use a multimeter in resistance mode to measure the resistance of the PTC heating element (approximately 20Ω-50Ω). If there is no resistance or the resistance is too high, the PTC heating element is damaged and should be replaced.

14. Leg Heating Function Malfunction

14.1 Turn on the heating function. Use a multimeter in DC voltage mode to measure whether there is DC 24V output at the leg heating connector on the main board (position 8). If there is no voltage output, the main board is damaged.

14.2 Use a multimeter in DC voltage mode to measure whether there is DC 24V voltage at the leg extension harness connector and the internal leg heating connector. If there is no voltage, check the connector or replace the corresponding leg extension harness assembly or the internal leg heating harness. If there is voltage, replace the heating cloth.

15. Seat and Waist Heating Function Malfunction

15.1 Turn on the heating function. Use a multimeter in DC voltage mode to measure whether there is DC 24V output at connector 7 (seat heating) or connector 9 (waist heating) on the main board. If there is no voltage output, the main board is damaged.

15.2 Use a multi meter in DC voltage mode to measure the voltage at the DC head of the seat heating or waist heating. If there is no

voltage, replace the seat or waist heating wiring harness. If there is voltage, replace the corresponding heating cloth.

16.Remote screen malfunction, button operation functions normal

16.1 Screen display malfunction, button operation functions normal: This is generally due to a faulty remote display screen. Replacing the remote assembly resolves the issue.

17.Speaker Not Working, Voice Abnormal

17.1 Speaker Not Working. Connect the phone via Bluetooth and play music. Measure the voltage at connector 17 on the mainboard to see if it is DC 12V. If there is no voltage output, the mainboard is damaged.

17.2 Check if there is DC 12V voltage at the voice board J1. If there is no voltage, check if the connector is normal; otherwise, replace the corresponding wiring harness. If there is voltage output, use an AC multimeter to measure if there is fluctuating voltage output at amplifier board J2 and J3. If not, replace the voice board. If there is voltage, after checking the wiring harness and finding no problems, replace the speaker.

17.3 If the checks in 17.1 and 17.2 are not problematic, check if the connector between the voice board and the microphone assembly is properly inserted and if the wiring harness continuity is normal. If

normal, replace the microphone assembly. Otherwise, replace the wiring harness.

17.4 Voice cannot be recognized. If the problem persists after steps 1, 2, and 3, replace the voice board.

17.5 Music synchronization abnormal. If the above steps are normal, check the connector connection and wiring harness continuity at point 23 on the motherboard. Replace the corresponding wiring harness if there is an abnormality. Check for audio output according to step 17.2. If there is audio, replace the main board; otherwise, replace the voice board.

III Mechanical Faults and Solutions:

1. Noise or malfunction of the lifting motor: Replace the lifting motor.

1.1If mechanism is stopped at the upper half of the backrest:

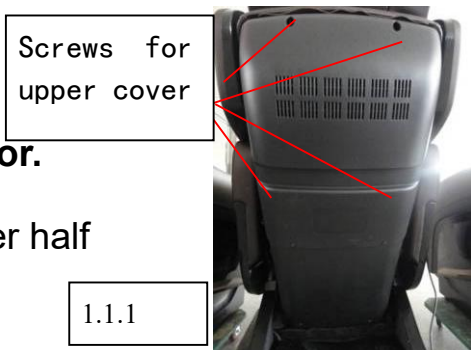

1.1.1 Use a screwdriver to remove the four screws securing the upper cover, and remove the upper cover.

1.1.2 Use a Phillips screwdriver to remove the four screws securing the lifting motor, and remove lifting motor assembly.

1.2 If mechanism is stopped at the lower

half of the backrest or the seat:

1.2.1 Remove Back cover

1.2.1.1 Use a Phillips screwdriver to remove the six screws on the upper, middle, and lower parts of the rear cover.

1.2.1.2 Slide the upper cover upwards and remove it.

1.2.2 Rotate the lifting counter wheel on the lifting motor to raise mechanism to the upper half of the backrest.

1.2.3 Use needle-nose pliers to cut off the safety cap connecting the lifting harness.

1.2.4 Use a Phillips screwdriver to remove the four screws securing the lifting motor and remove the lifting motor assembly.

Reinstall the replaced lifting motor assembly following the reverse steps above.

Notes: 1. Apply a suitable amount of grease to



图 1.2.3



图 2.1.3

Screw for shoulder

the worm gear on the lifting motor before installation;

2. Ensure the safety cap is securely installed when connecting the lifting harness.

2 Replacing Mechanism

2.1 Removing the Shoulder Assembly:

2.1.1 Unzip the shoulder seam.

2.1.2 Lift the shoulder airbag and use a Phillips screwdriver to remove the screws securing the shoulder.

2.1.3 Rotate the shoulder assembly upwards and move it slightly outwards. Then, disconnect the air hose and connector, and remove the shoulder assembly.



图 2.2.3

2.2 Removing the Armrest Assembly:

2.2.1 Pull the left and right side airbag assemblies upwards and disconnect the air hoses.

2.2.2 Disconnect the air hoses and connectors from the armrest assembly.

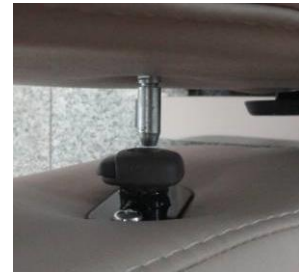
2.2.3 Use a Phillips screwdriver to remove the two screws securing the armrest. Turn the front end of the armrest upwards to dislodge the square tube inserted into the seat surface; press the clip connecting the rear end of the armrest to the backrest and slide the entire armrest



图 2.4.1

outwards to remove it. (The same method applies to both left and right armrests.)

2.3 Remove the upper and lower rear covers: Same as 1.2.3.

2.4 Remove the backrest assembly

2.4.1 Remove the 8 screws securing the backrest assembly from the back side, and tilt the assembly forward.

2.4.2 Remove the 8 screws (4 on each side of the top of the backrest frame) and remove the upper panel assembly.

2.4.3 Raise mechanism to its highest position and rotate the lifting counter wheel on the lifting motor until mechanism disengages from the rack.

2.4.4 Use diagonal pliers to cut the wire clip at the top of mechanism and disconnect the air hose.

2.4.5 Use a Phillips screwdriver to remove the 2 screws securing the circuit board cover; disconnect the wiring harness connector on the circuit board.

2.4.6 Remove mechanism from the top of the backrest.



图 2.4.2



Reinstall the new mechanism following the reverse steps above.

3.The air pump is not working and needs to be replaced.

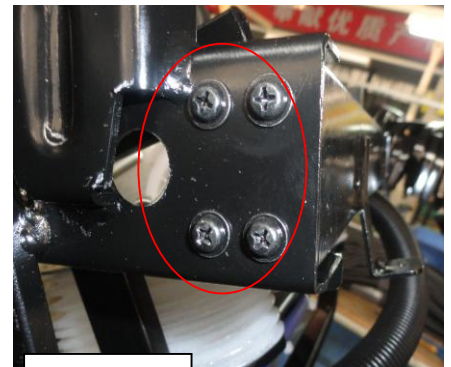
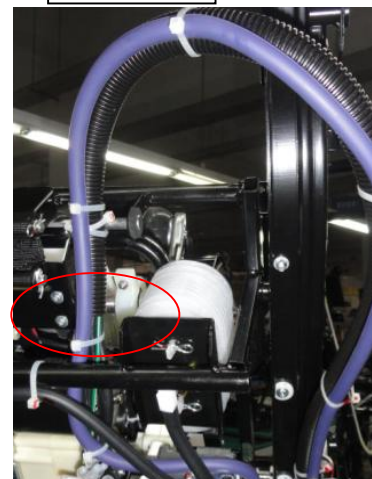
3.1 Remove the leg assembly.

3.1.1 Use a Phillips screwdriver to remove the two screws securing the leg assembly. Flip the pivot plate upwards, lift the leg assembly upwards, and remove it.



图 3.1.1

3.1.2 Disconnect the three air hoses and electrical connectors from the front panel.

3.2 Remove the front fender.

3.2.1 Use a Phillips screwdriver to remove the four screws securing the front fender at the top.

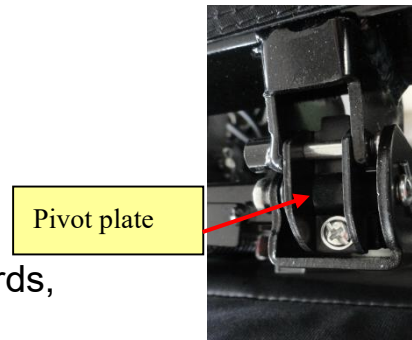
3.2.2 Hold the front fender by hand and lift it upwards; this will dislodge the front fender from the groove at the bottom.



图 3.2.1

3.3 Remove air pump.

3.3.1 Connect the power supply, turn on remote, and start any automatic program. Touch the air pump and check which of the two pumps does not vibrate. The pump that does not vibrate may

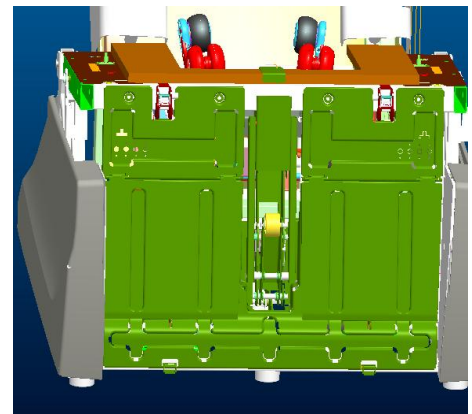
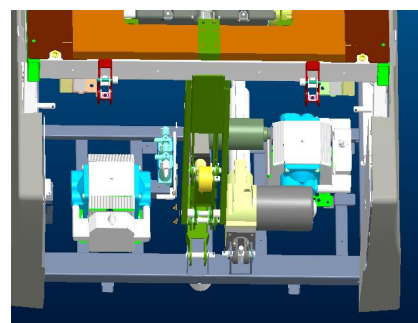

be damaged; turn off the power.

3.3.2 Disconnect air hose from air pump. Use a Phillips screwdriver to remove the four screws securing the air pump. Use diagonal pliers to cut the wire clip on the air pump connector and disconnect the connector.

Reverse the steps above to install the new air pump.

4. The solenoid valve is not working need to be replaced.

4.1 Remove the leg section. Same as 3.1.

4.2 Remove the front panel. Same as 3.2.

4.3 Set the massage chair to zero gravity (this step is unnecessary if the two-valve solenoid valve set at the bottom of the seat frame is removed). Power on; turn on the power switch on the power box at the back of the massage chair; press the power button on remote to turn it on. After entering the function selection interface, press the zero gravity button at the bottom center of the remote to recline the backrest. Turn off the power and unplug the power cord.

4.4 Disassemble the solenoid valve (there are two sets of five-valve solenoid valves on the backrest frame and one set of two-valve solenoid valves at the bottom of the seat frame).

Disconnect the air tube from the solenoid valve (you can take a

picture of the insertion sequence with your phone before disconnecting the air tube); use a Phillips screwdriver to remove the four screws securing the solenoid valve, use diagonal pliers to cut the wire binding the cable and attach it to the connector, disconnect the connector of the solenoid valve assembly, and remove the solenoid valve.

Reinstall the newly replaced solenoid valve assembly following the reverse steps above.

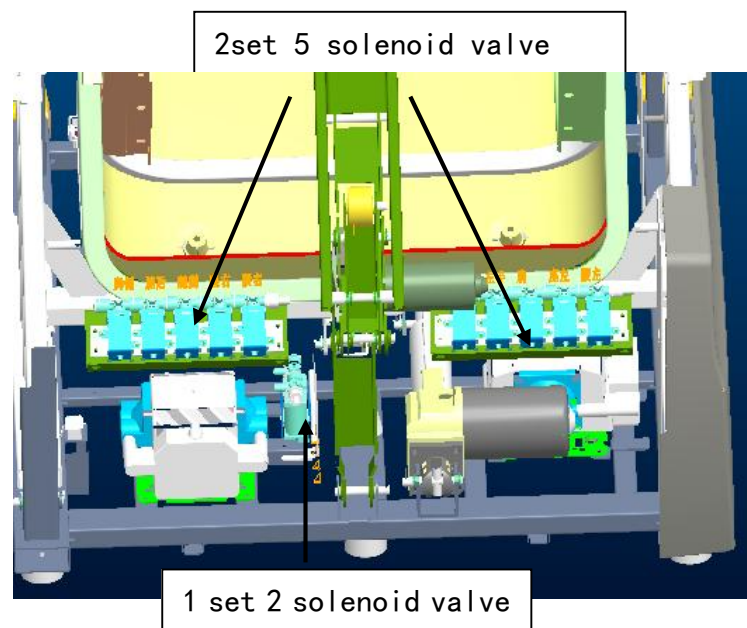

5. The leg actuator is not working and needs to be replaced.

5.1 Remove the leg rest. Same as 3.1.

5.2 Remove front panel. Same as 3.2.

5.3 Remove the pine needle pin on the actuator pin, take off the actuator, use diagonal pliers to cut the wire

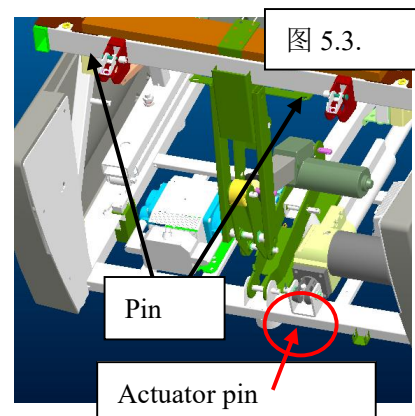

binding the harness and fasten it to the connector, then disconnect the connector. Reverse the steps above to install the new leg actuator.

6. The front sliding actuator is not working and needs to be replaced (requires 2 people).

6.1 Remove the leg section. Same as 3.1.

6.2 Remove the front panel. Same as 3.2.

6.3 Tear off the rear cover in front of the power box by hand.

6.4 One person holds the backrest forward while the other person removes the front and rear pins and hinge pins of the front sliding actuator.

Use diagonal pliers to cut the wire binding and disconnect the connector of the electric actuator. Reverse the steps above to install the newly replaced electric support rod.

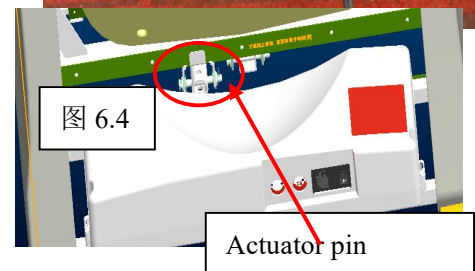

7. Replace the foot rollers.

7.1 Remove leg assembly. Same as 3.1.

7.2 Use a Phillips screwdriver to remove the four screws

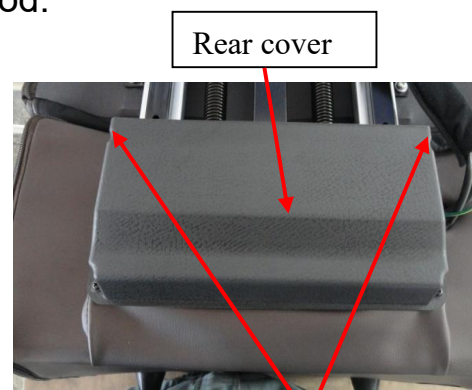

Securing rear cover, then remove the rear cover.

7.3 Remove the two springs, and use a Phillips screwdriver to

remove the four screws securing the assembly. Unzip the zipper between the leg seams. Use diagonal pliers to cut the thread binding the air tube, then remove the leg assembly.

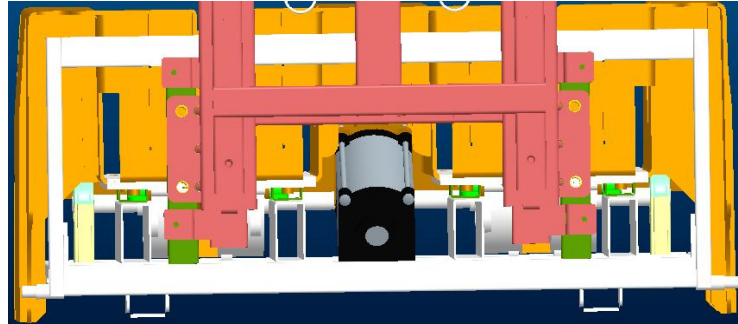

7.4 Rotate the caster and remove the three screws securing it in sequence to remove the leather cover. The same disassembly



method applies to the other side.

7.5 Remove the screws securing the caster and remove the caster.



The disassembly method is the same on the other side.

7.6 Remove the two screws securing the caster cover and remove the caster cover. The disassembly method is the same on the other

side.

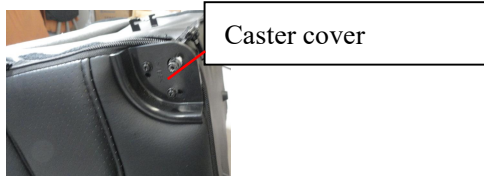

7.7 Unzip the sewn-up parts one by one and remove the wooden board at the bottom of the foot.

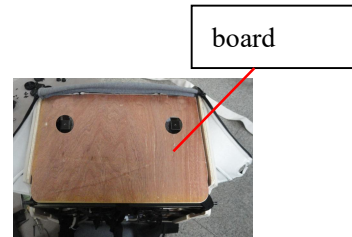

7.8 Loosen all the straps on the sewn-up parts and cut the nylon cable ties binding the wires and air tubes.

7.9 Remove the 9 screws securing the foot body and remove the foot body.

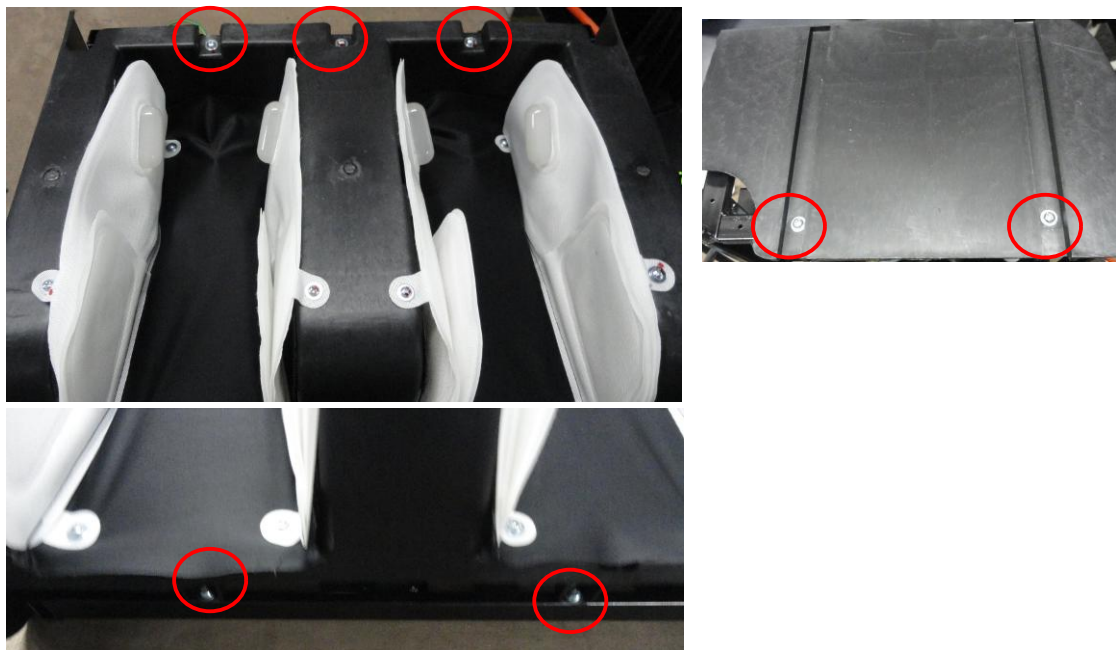

7.10 Remove the screws securing foot roller as shown in the diagram;

remove foot roller

Reverse the steps above to complete the installation of footroller.

