

7516E massage chair service guide

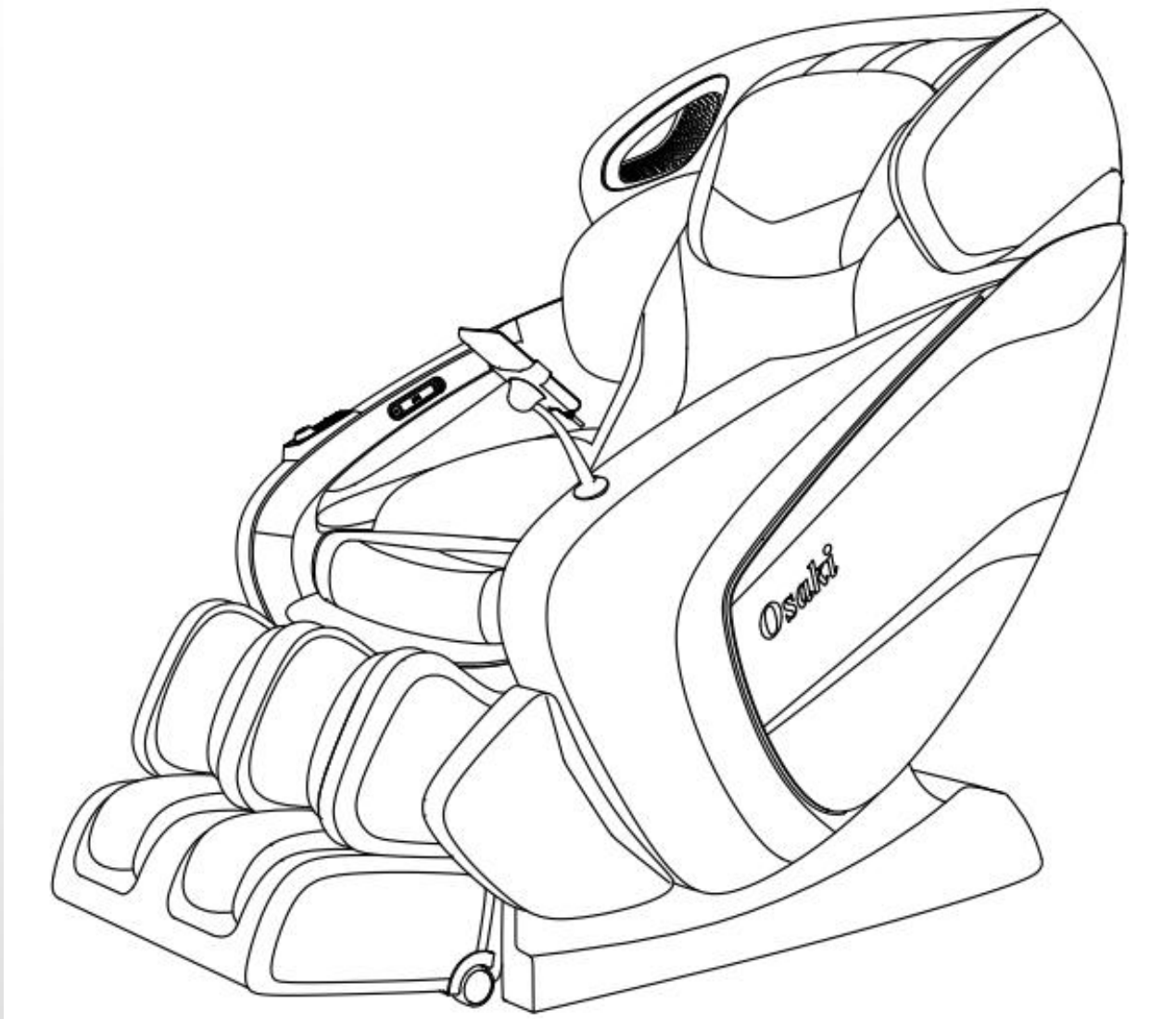

Table of Contents

- 一、 Product introduction
- 二、 Massage chair tools and use
- 三、 Circuit working principle
- 四、 Massage chair removal instructions
- 五、 Massage chair fault judgment



一、 Product introduction

1、 Product appearance:

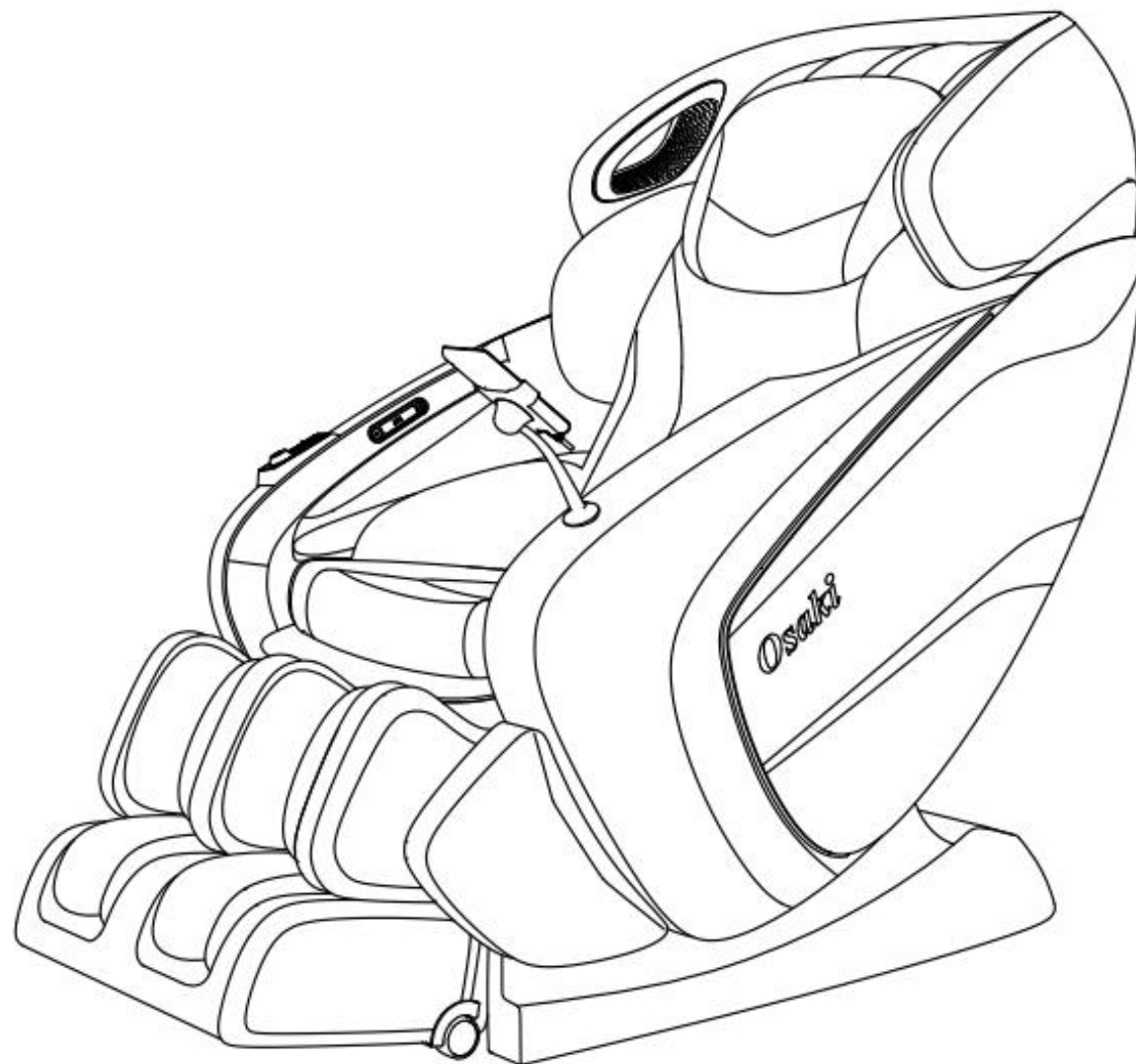

2、Appearance of the whole machine:

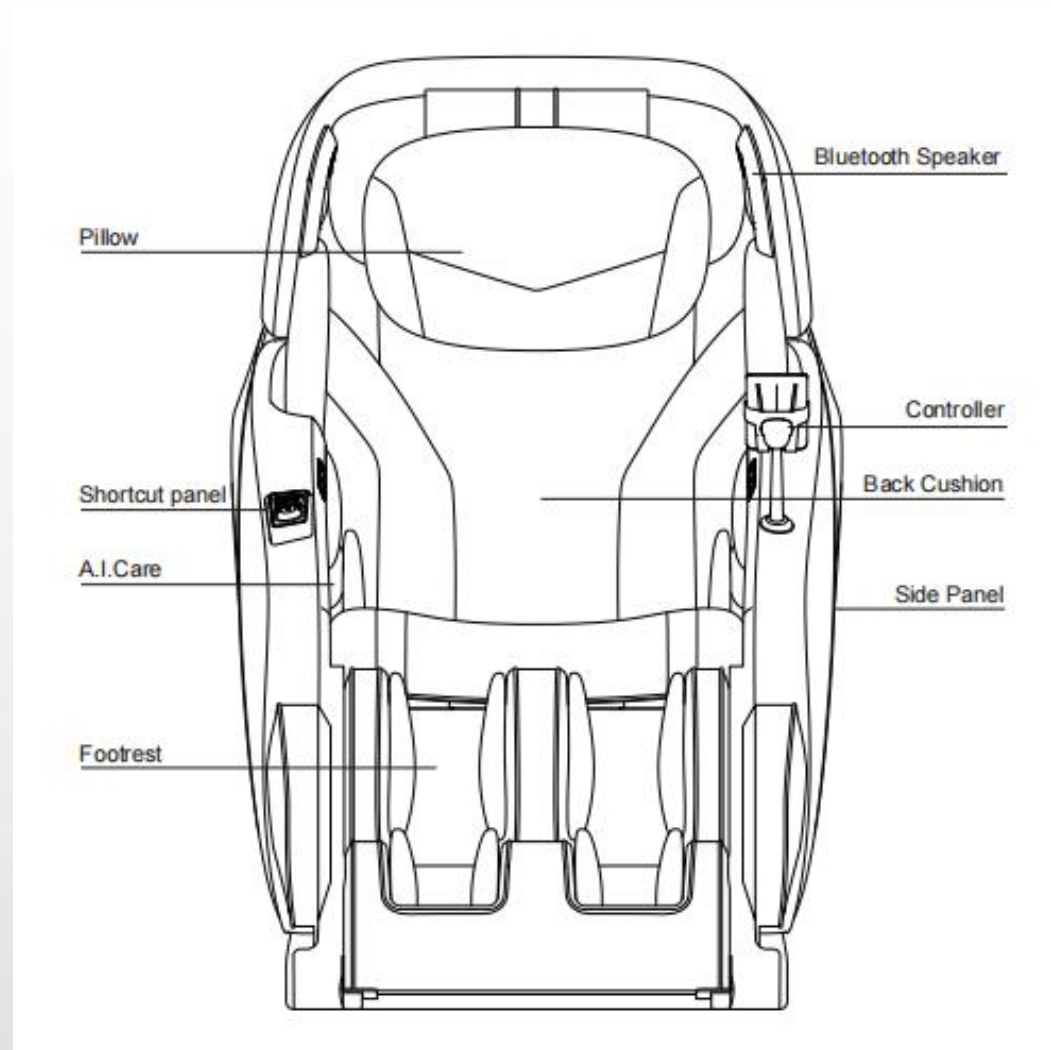

3、specifications of the products:

Description	Specifications	
Model No.	AI 3D Envy	
Rated Voltage	110-120V~	
Rated Frequency	60Hz	
Rated current	1.2A	
Timer	5/10/15/20/25/30 minutes	
Dimension (L x W x H)	Product carton	Unit:58.7**33.1**42.7"
		Footrest:23.2**20.1**21.7"
Weight	Product gross weight: 280 lbs	
	Product net weight: 236 lbs	
Length of the wire	Controller wire: 39.4"	
	Power supply wire: 70.9"	
Usage condition	Environment temperture: 50°F-104°F	
	Contrasting humidity: 30-85RH	
Storage condition	Storage temperature: 68°F-140°F	
	Storage humidity level: 30-85RH	
Safety feature	Equipped with overheated and power surge safety protection.	
Using benefits	Increasing blood circulation; Relieving muscular fatigue	

二、 Massage chair tools and use

1.tools

					
Screwdriver size 1,2,3	Diagonal cutter and long nose pliers	Soldering Kit	Spanner tools Kit	Test pen	Allen Key set
					
Ratchet Tools Set	24V/DC power	Electric Driver	electrical adhesive tape	Cable Ties	WIRE ONECTORS

2.Usage of multimeter

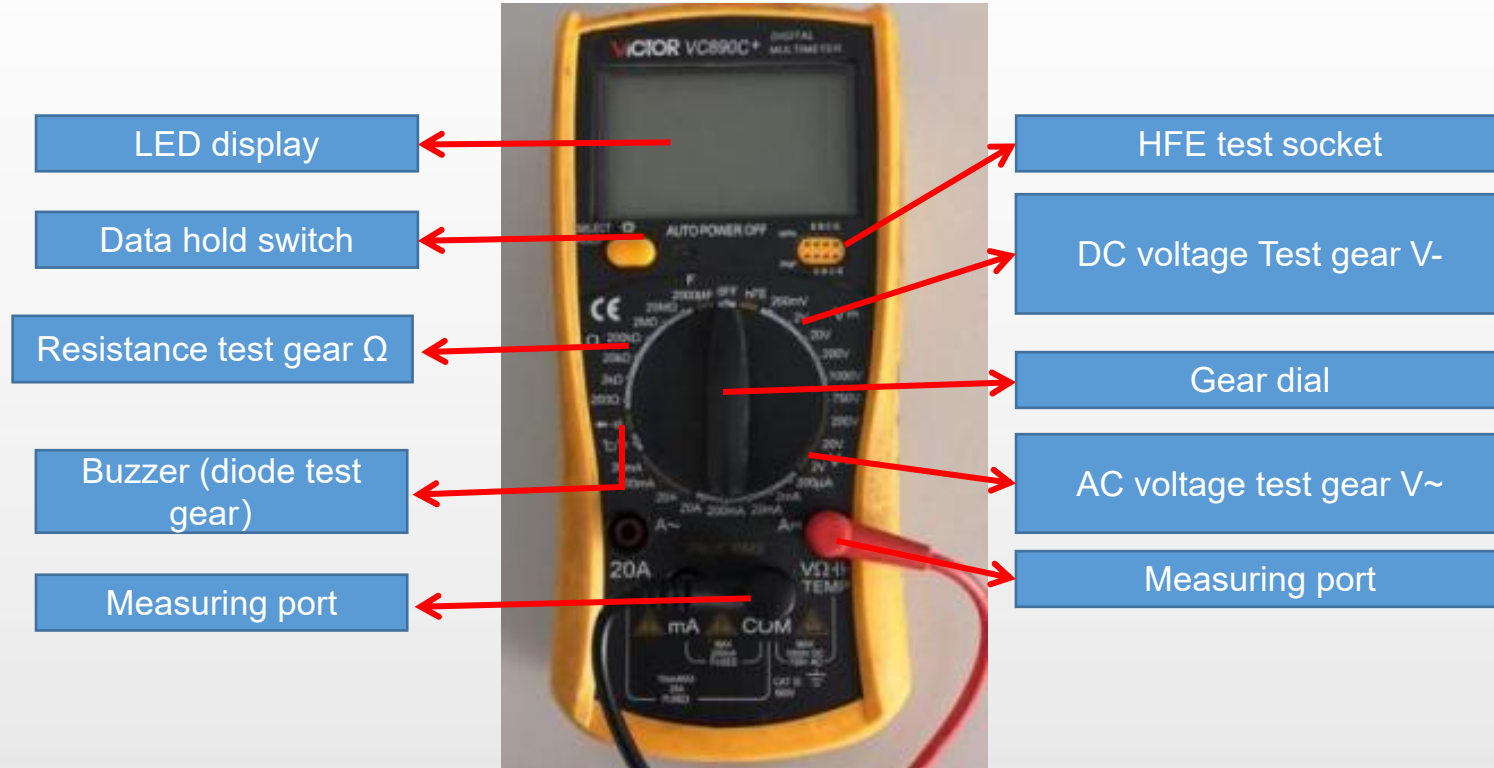

2.1、 Function of the test gears

Data hold switch: Memorize the measured data for comparison.

Buzzer (diode test gear) : Measure the quality of diode, the on-off and alarm function of circuit

Resistance gear test gear: Measure the quality and value of resistance

DC voltage Test gear V-: Measure DC voltage

AC voltage test gear V~: Measure AC voltage

VΩ / COM: VΩ Red pen port (+ pole) during test, black pen port (- pole) during com test

Note: when carrying out resistance or voltage test, it is necessary to select a suitable range. If the range is too small to be measured, and the range is too large, the test error range is large; if the voltage is not known, it is necessary to select a range measurement with a large windlass.

2.2、 On / off measurement of lines



open circuit

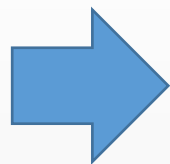

As shown in the left picture, first set the multimeter to the buzzer and power it

When the switch is on, the multimeter will display "0."; then contact the two probes with the ends of the red wire

At this time, the multimeter still shows "1." there is no change, which means there is an open circuit in the middle of the wire, that is, the line is open.



close circuit



As shown in the picture on the left, if the multimeter shows the number of ". 002" or ". 00n" and gives an alarm, it means that the wire is connected.

2.3、 Measurement of AC voltage



As shown in the picture above: measure the household plug-in board power supply (220V), select the range of 750, and the test result shows "224", indicating that the actual voltage of this group of sockets is 224v at the moment (the switch is pressed down, so there is power, and the light is on).



As shown in the above picture: measure the power supply (220V) of our household plug-in board, select the range of 750, and the test result is displayed as "001", indicating that the actual voltage of this group of sockets is 0V at the moment (the switch is not pressed down, so there is no power, and the light is not on).

三、Circuit working principle

1、Internal structure diagram (overall):

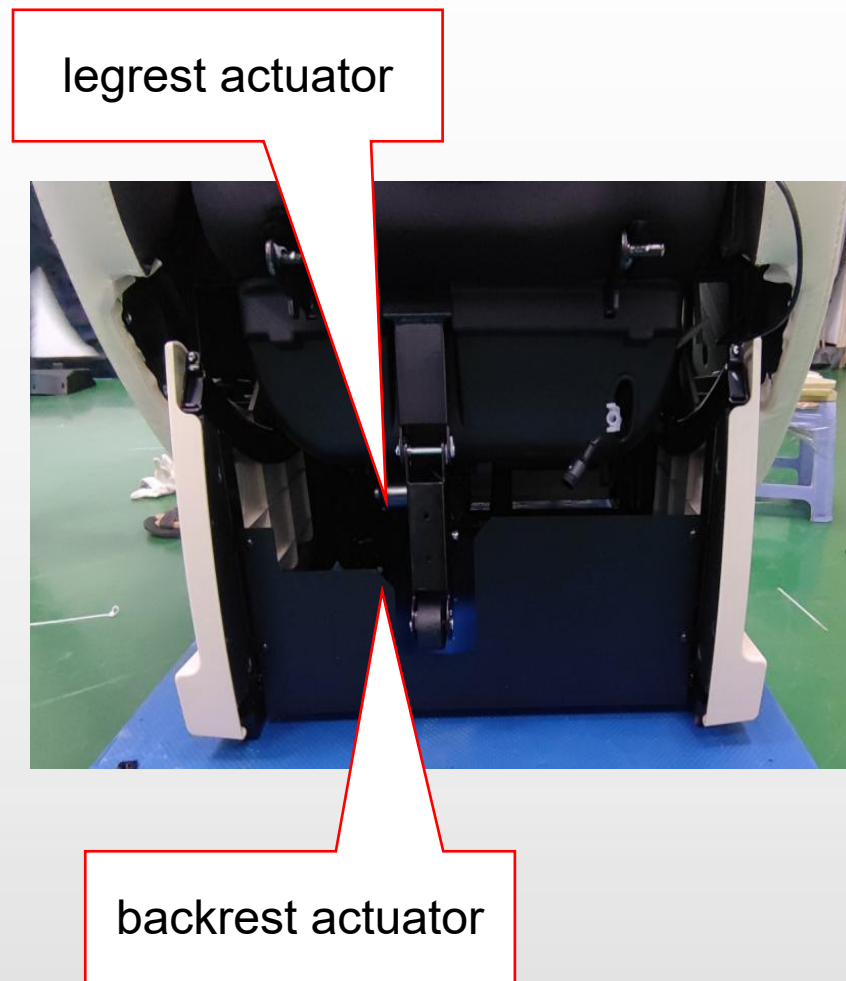
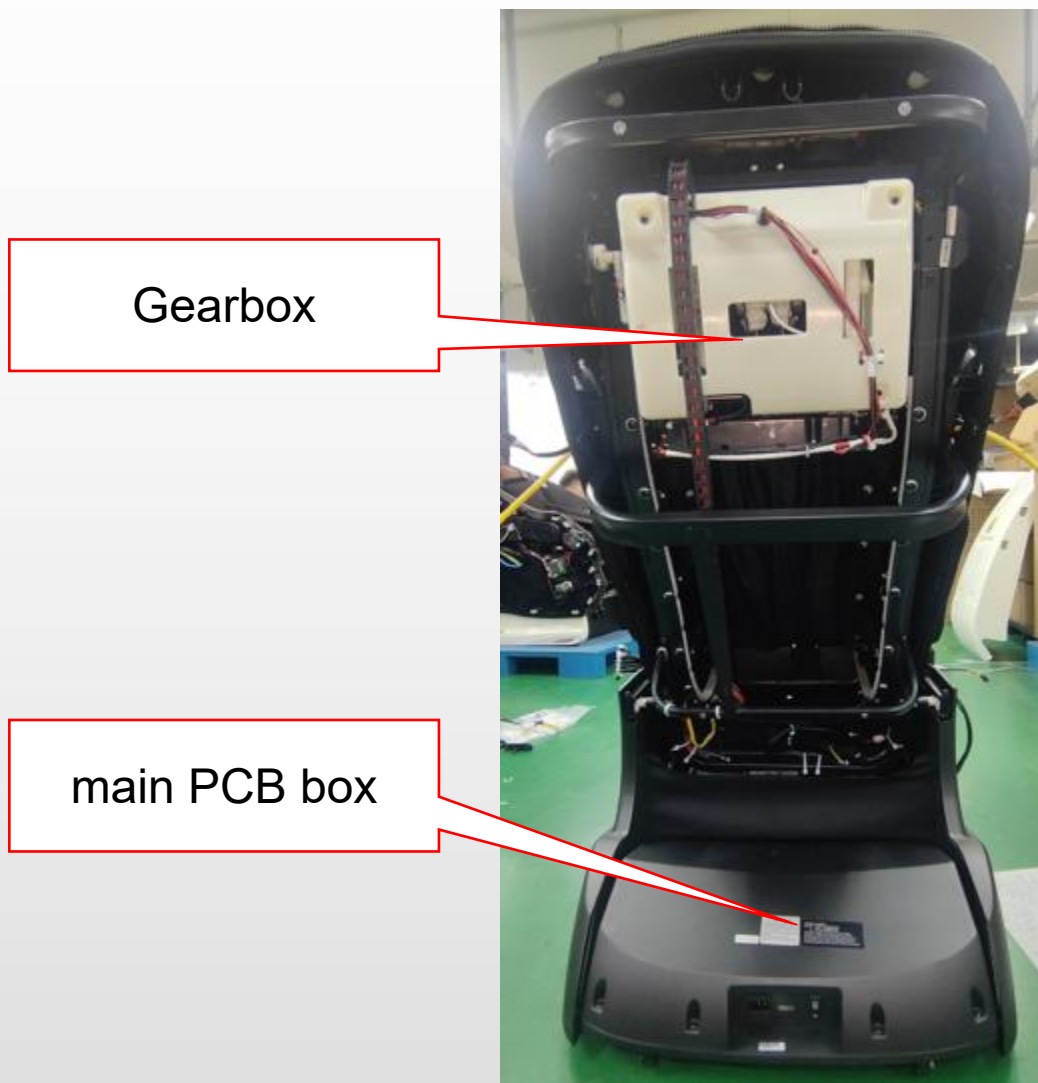

2、 Internal structure diagram (main PCB box):

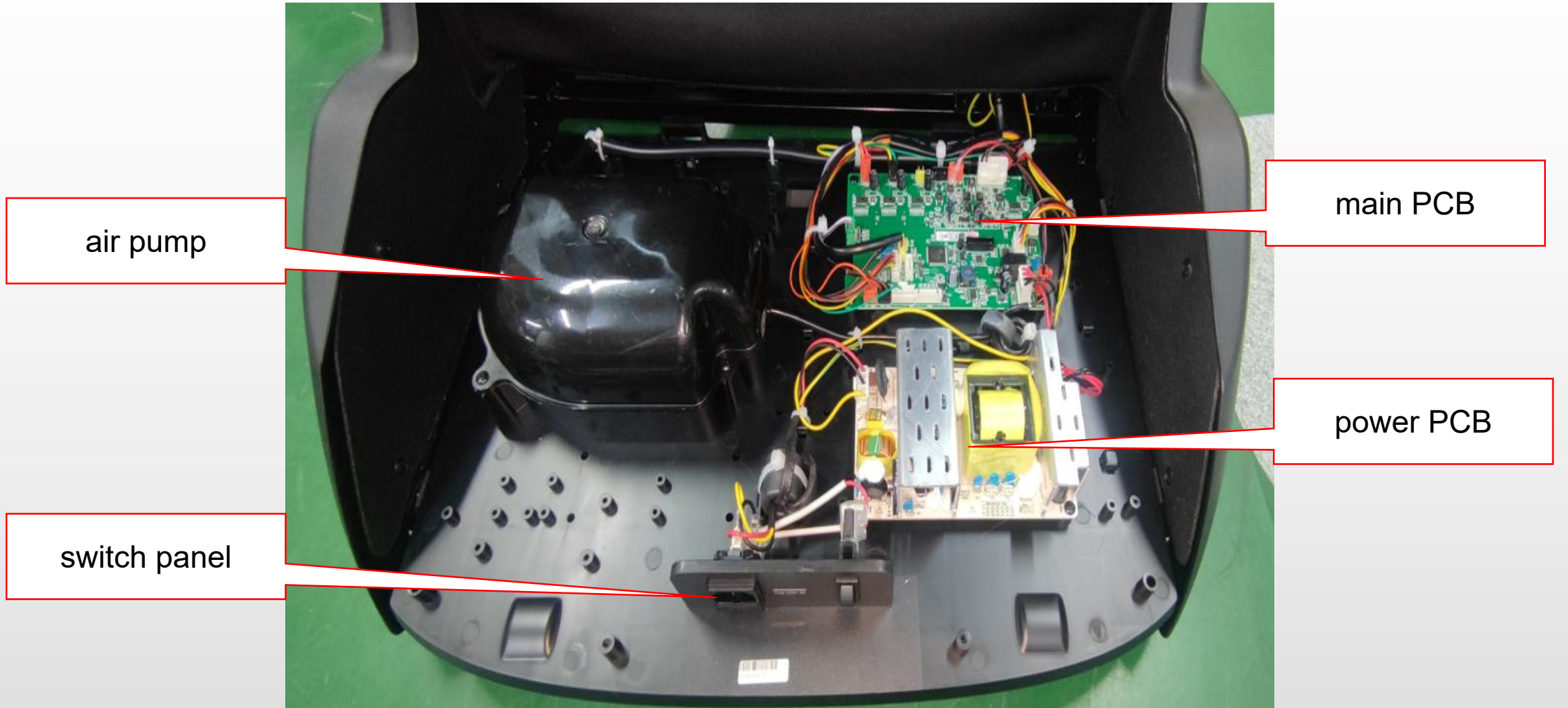

3、 main PCB:

J17: legrest actuator , connect underseat PCB J4

J16: backrest actuator

J7: Lumbar heating, connect underseat PCB J3

J20: Gearbox

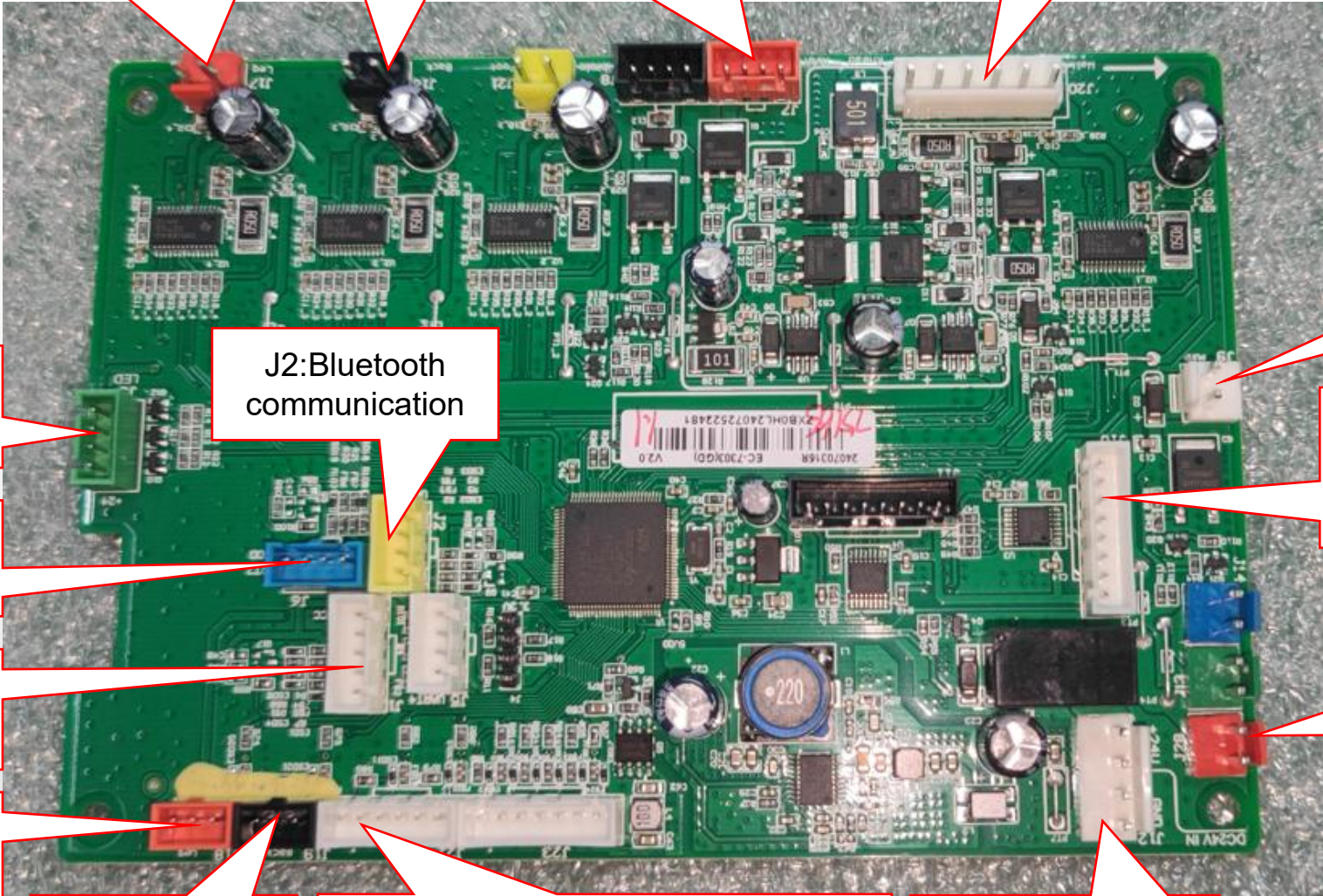

J3: 3-COLOUR LED(24VCC), connect underseat PCB J3

J2:Bluetooth communication

J9:air pump

J10: arm inflate, shoulder inflate, seat side inflate, connect undeseat PCB J5

J6: Pain detection, connect underseat PCB J2

J1: remote controller ,connect underseat PCB J1

J28:24V connect underseat PCB J4

J18: legrest counting sensor, connect underseat PCB J2

J19: backrest counting sensor

J22: Upper and lower limit detection ,connect underseat PCB J1

J12:connect power PCB CON2

4、underseat PCB:

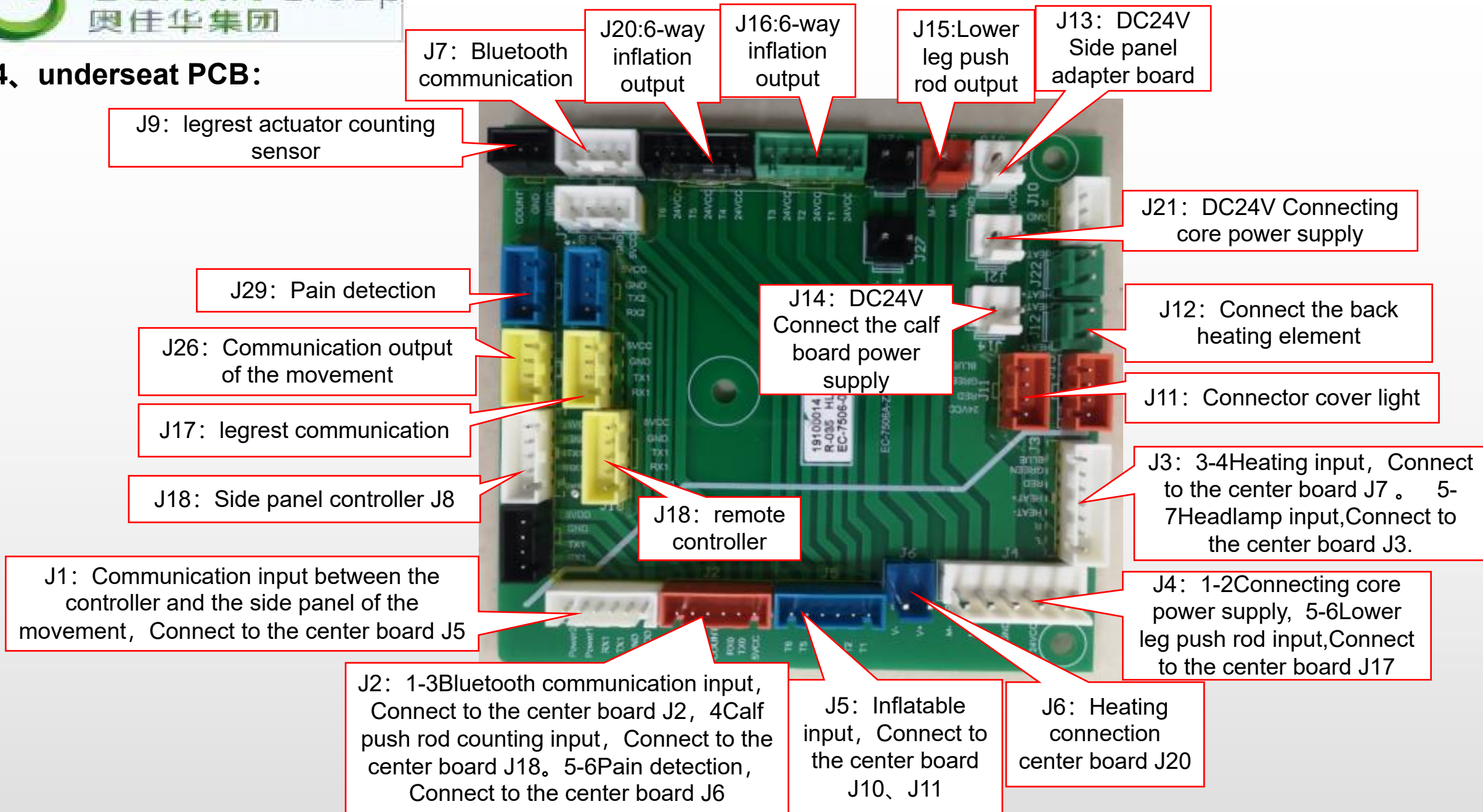

J7: Bluetooth communication

J20:6-way inflation output

J16:6-way inflation output

J15:Lower leg push rod output

J13: DC24V Side panel adapter board

J9: legrest actuator counting sensor

J21: DC24V Connecting core power supply

J29: Pain detection

J14: DC24V Connect the calf board power supply

J12: Connect the back heating element

J26: Communication output of the movement

J11: Connector cover light

J17: legrest communication

J3: 3-4Heating input, Connect to the center board J7。 5-7Headlamp input,Connect to the center board J3.

J18: Side panel controller J8

J18: remote controller

J1: Communication input between the controller and the side panel of the movement, Connect to the center board J5

J4: 1-2Connecting core power supply, 5-6Lower leg push rod input,Connect to the center board J17

J2: 1-3Bluetooth communication input, Connect to the center board J2, 4Calf push rod counting input, Connect to the center board J18。 5-6Pain detection, Connect to the center board J6

J5: Inflatable input, Connect to the center board J10、 J11

J6: Heating connection center board J20

5、 power PCB:

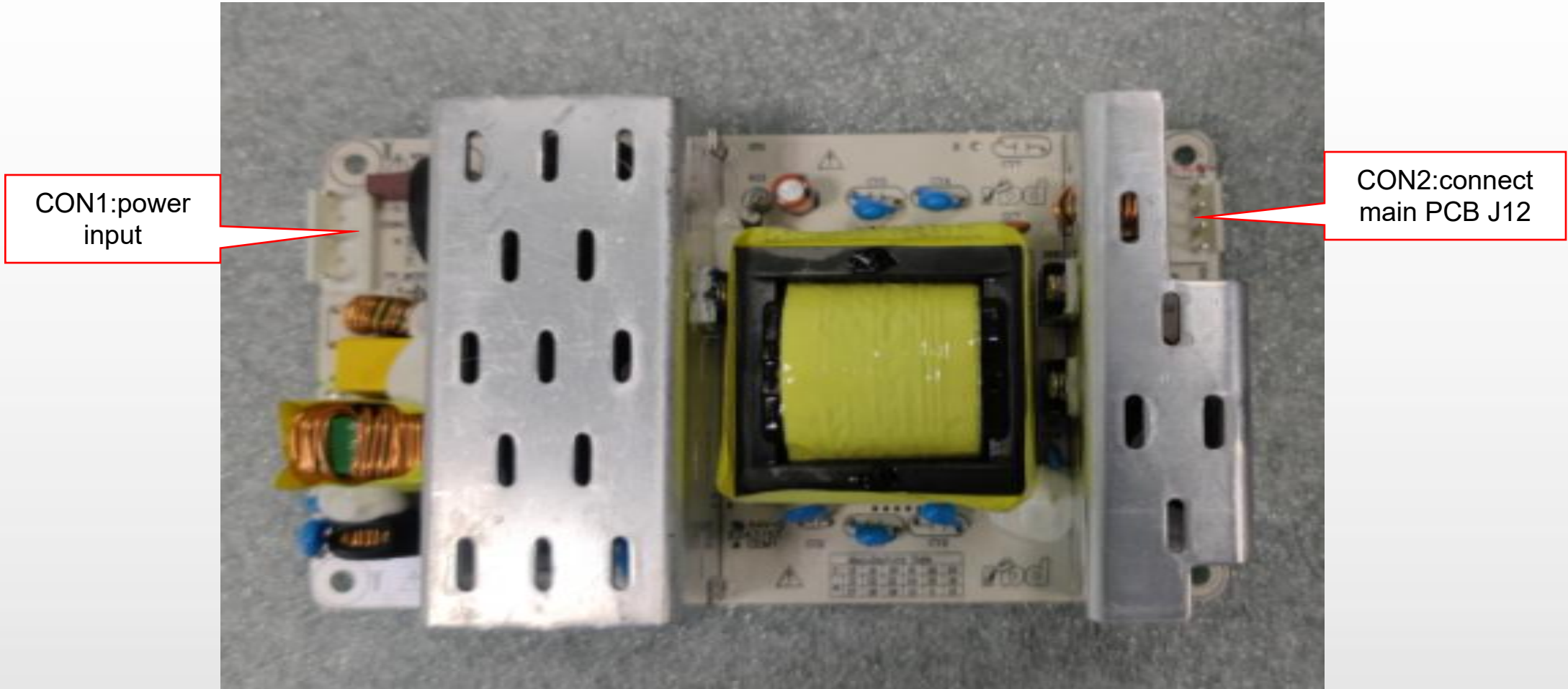

6、 upper Gearbox PCB:



J7: 24V,connect
underseat PCB J13

J6-1:telescopic motor

J6-2:tapping motor

J6-3:kneading motor

J5: telescopic motor

J4: signal ,connect
underseat PCB J26

J2:Movement
detection signal

J3:Movement
detection signal

7、right side panel connect PCB:



J2: power connect Bluetooth PCB J1

J2: Connect to USB charging board J2

J5: Connect to Bluetooth communication

J10: Connect Bluetooth amplifier board J1 and voice board J1

J1: Connect the seat adapter board and head cover speaker



8、Charging PCB :



9、 Bluetooth PCB :

J6: AUDIO,Side panel
adapter board J3

J1:24V power
input,Side panel
adapter board J3



J16:
communicate, Si
de panel adapter
board J4

10、legrest PCB:

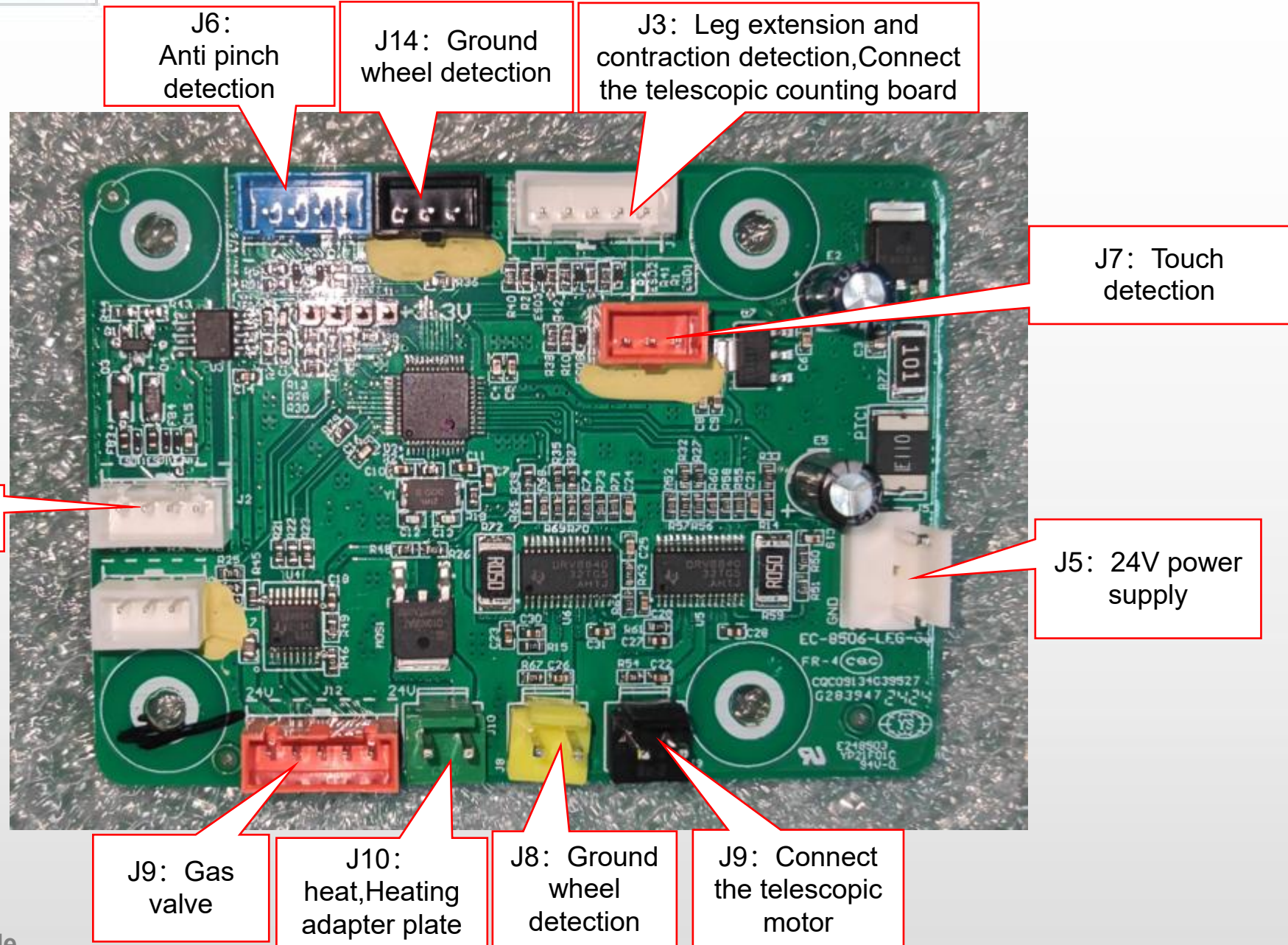

四、Massage chair removal instructions

1、disassembly of the pillow:



A.unzip the zipper



BIG pillow

2、disassembly of backrest pad:



A..unzip the zipper

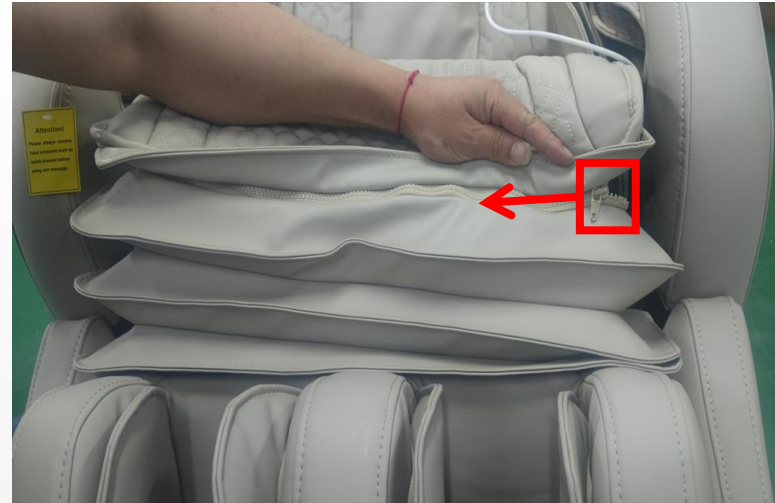

B.unzip the zipper



C.unzip the zipper

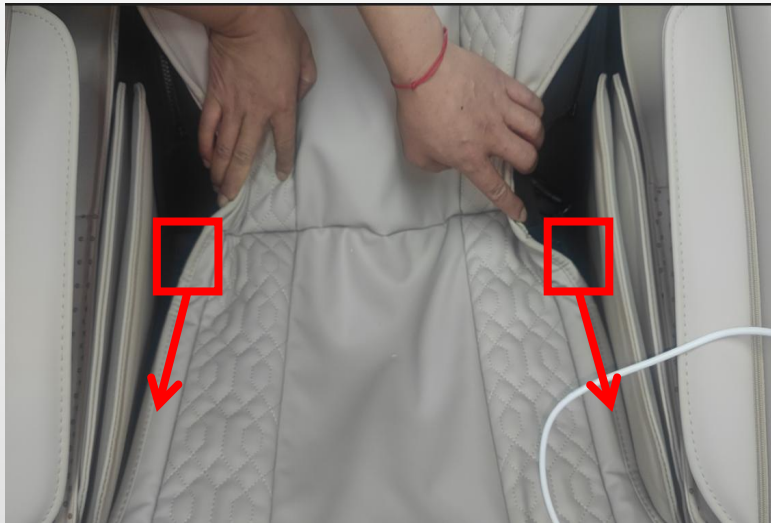

D.unzip the zipper



E.unzip the zipper

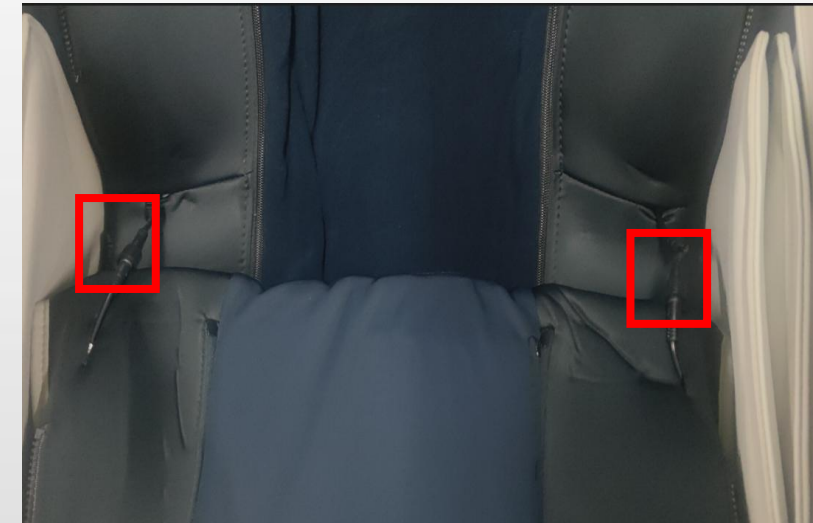

F.Disconnect the connecting wire



backrest pad



G.unzip the zipper

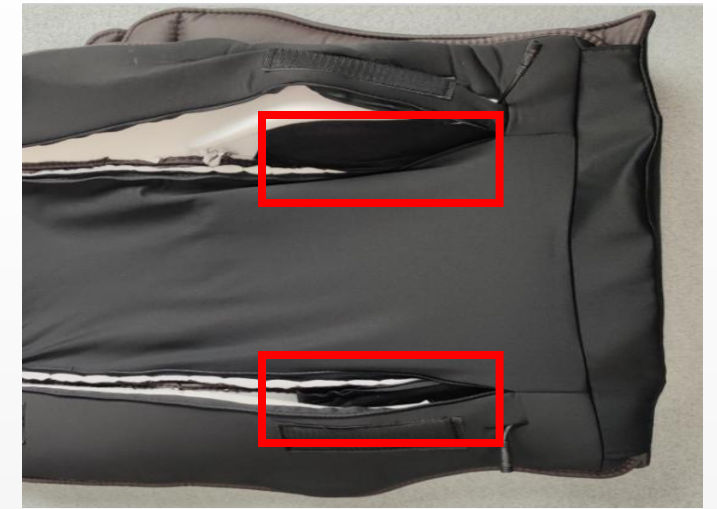

H.Tear open the adhesive button to remove the heating wire



heating wire

3、disassembly of right side panel:



A.remove 1 screws

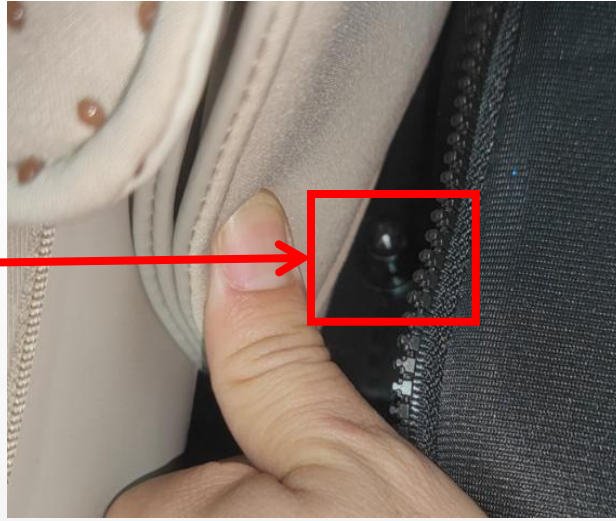

B.Lift up the front end of the side panel and then move the entire side panel forward

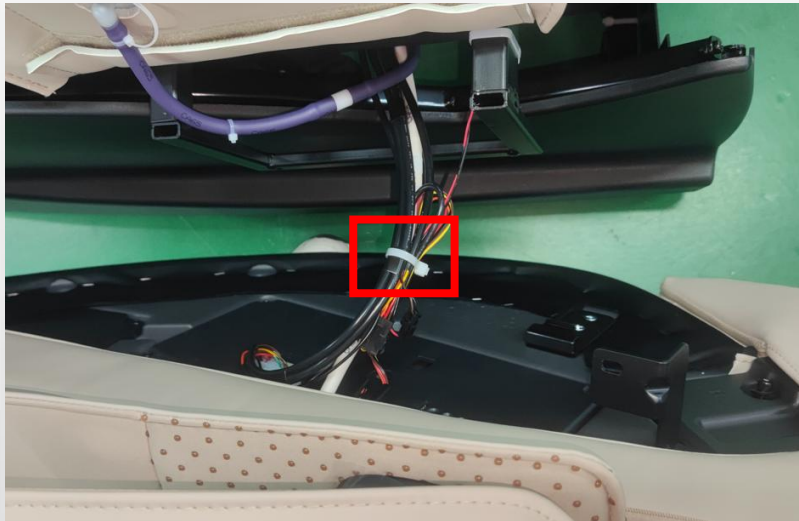

C.cut off the zip ties

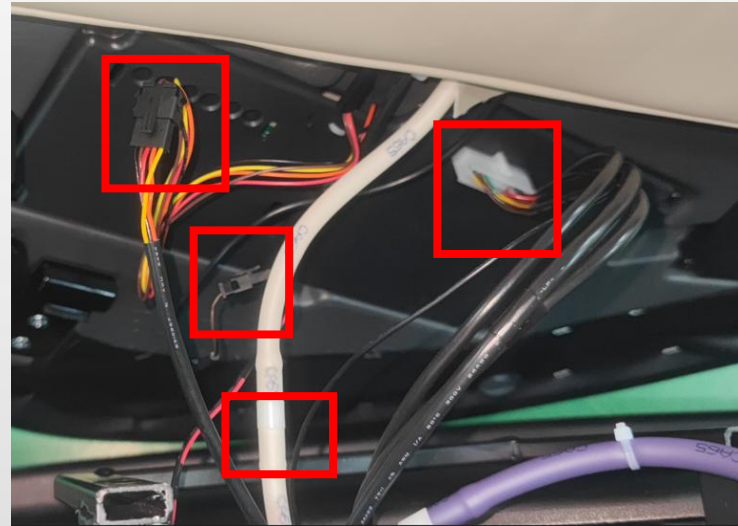

D.disconnect the terminal and air hose



right side panel

4、 disassembly of inner right side panel:



A.remove 2 screws



Side panel baffle



B.remove 5 screws

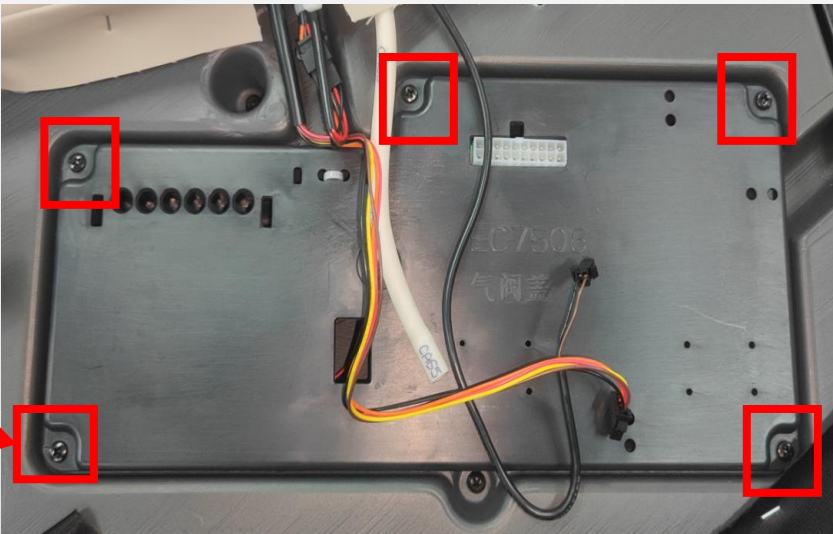

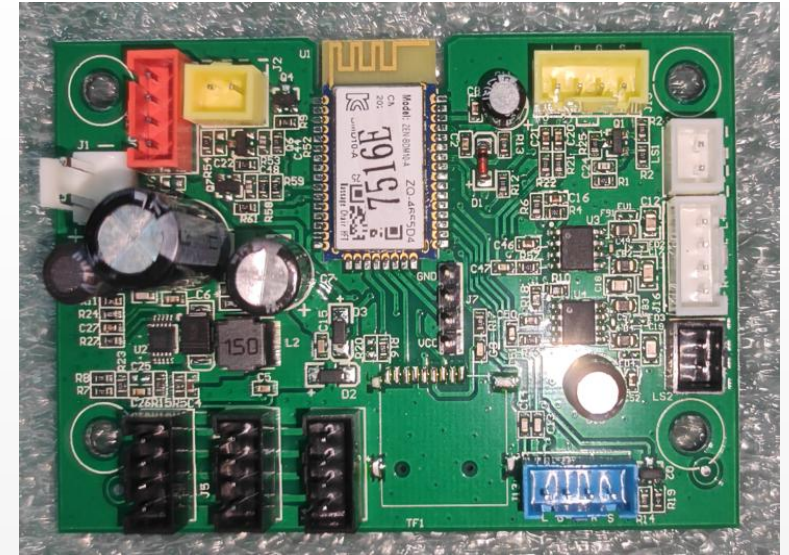
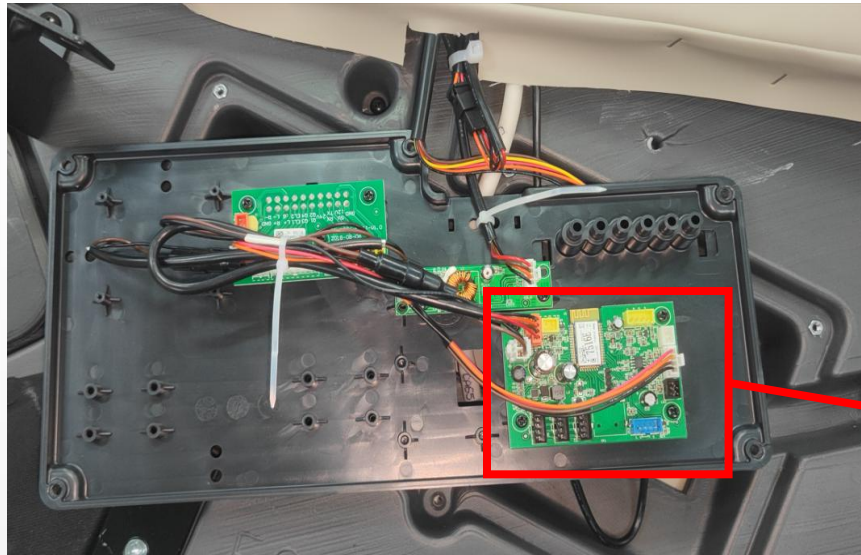

C.disconnect the terminal,remove 4 screws

Bluetooth board

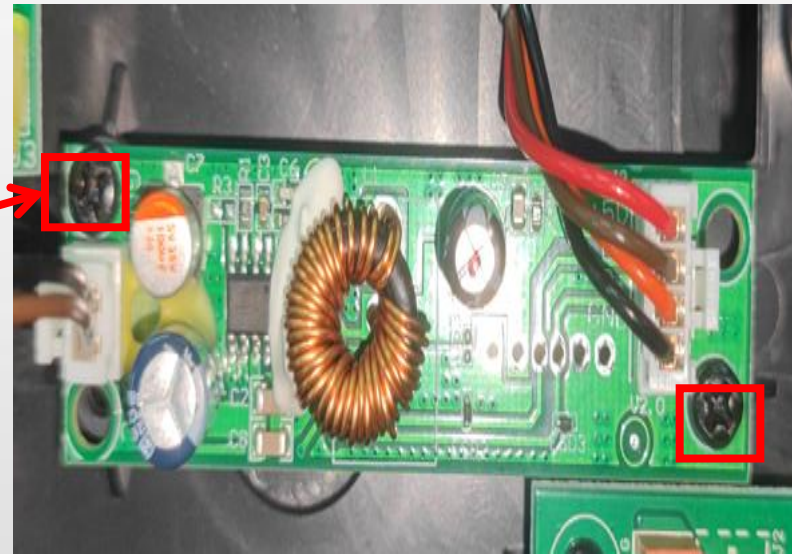
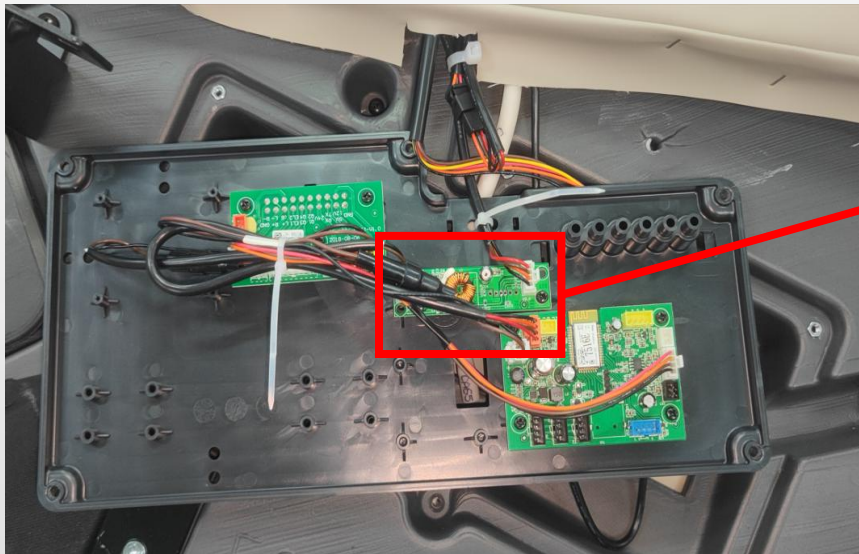

D.disconnect the terminal,remove 2 screws

USB charging pad

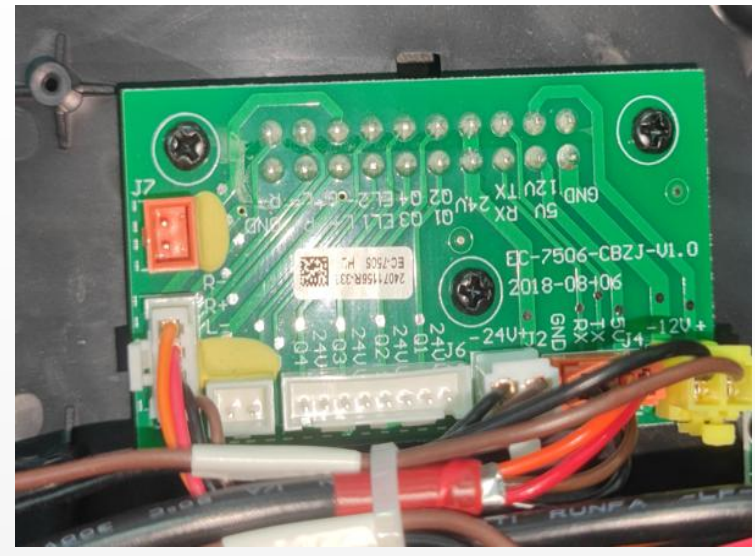
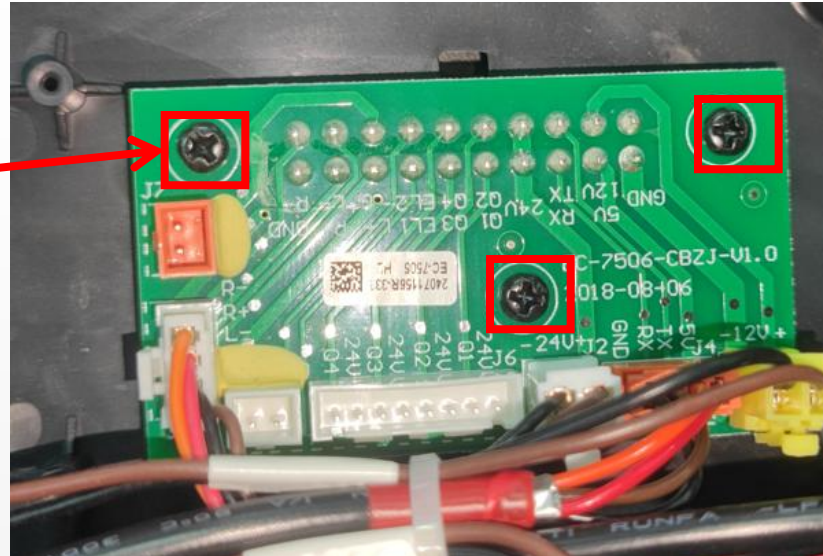
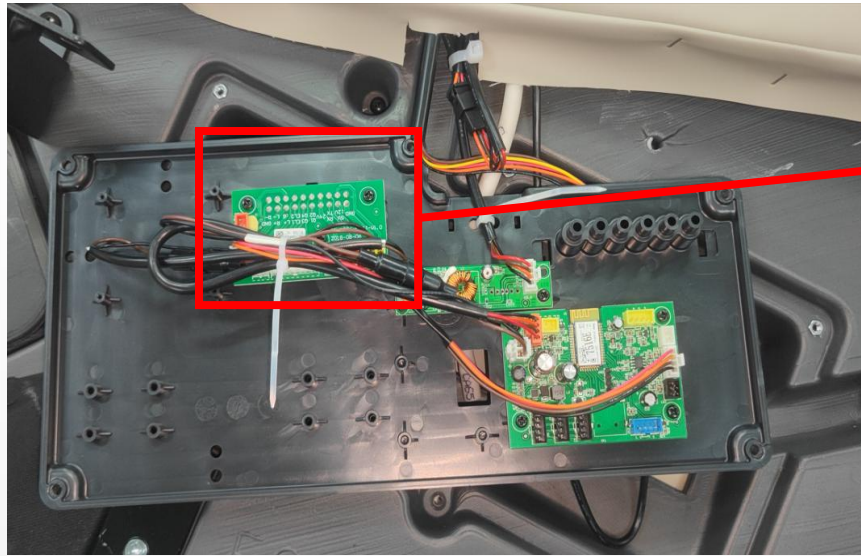

E.disconnect the terminal,remove 3 screws

side panel switch PCB

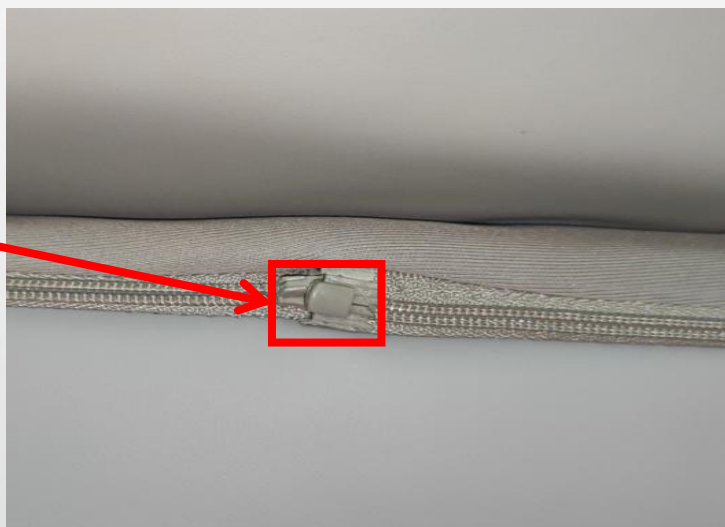
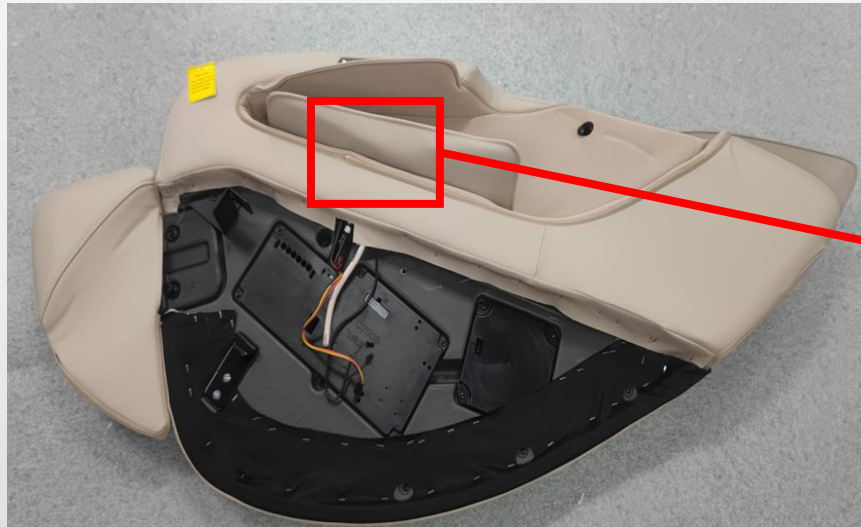

F.unzip the zipper



G.cut off the zip ties,remove 4 screws

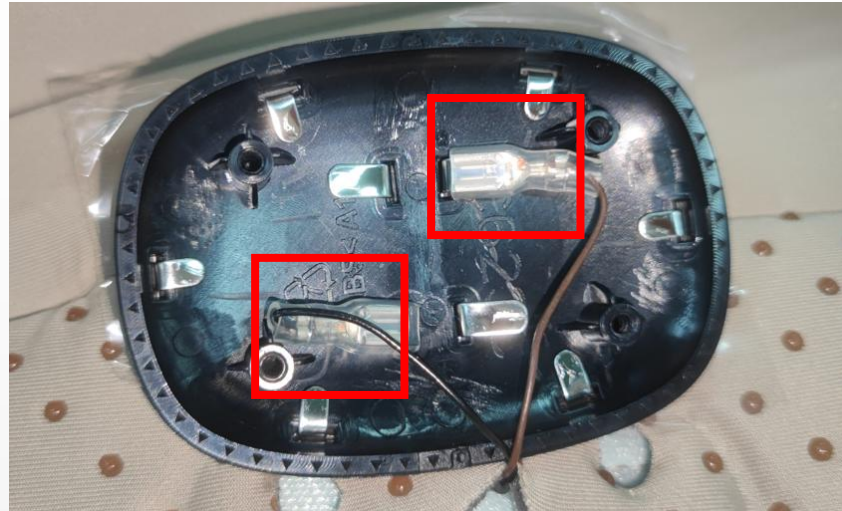

H.disconnect the terminal



pain detection



I.break open the cloth cover pin
7516E massage chair service guide



right armrest leather cover



J.remove 4 screws



right arm airbag



K.tear open the veneer,remove 2 screws



USB charging cover

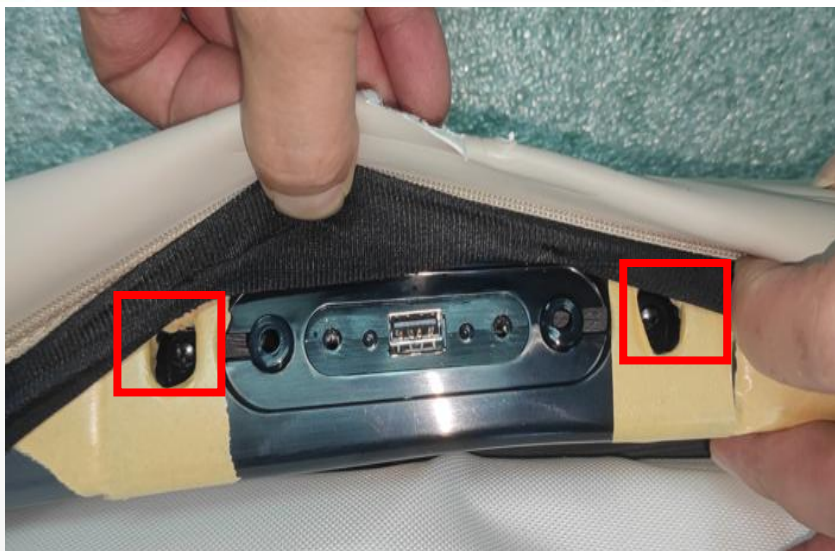

L.remove 2 screws



M.remove 2 screws



N.cut off the buckle and disconnect the connecting wire



O.tear open the veneer,remove 2 screws



P.disconnect the connecting wire

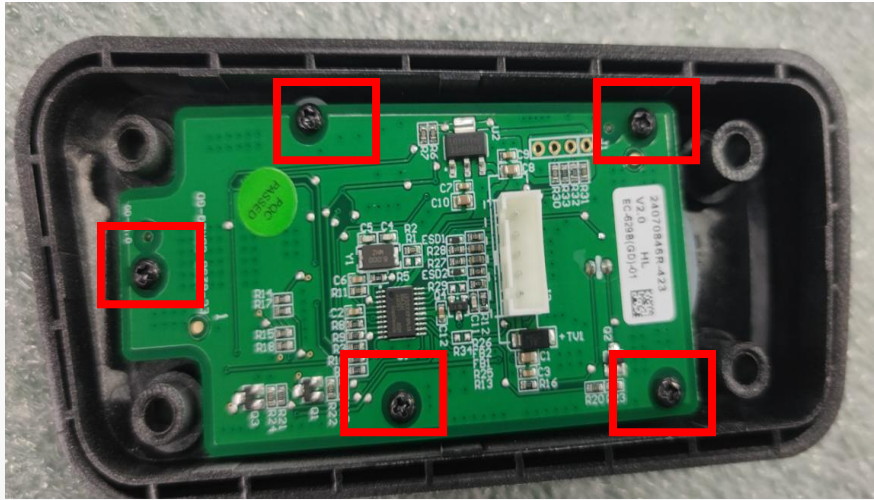

Q.remove 5 screws

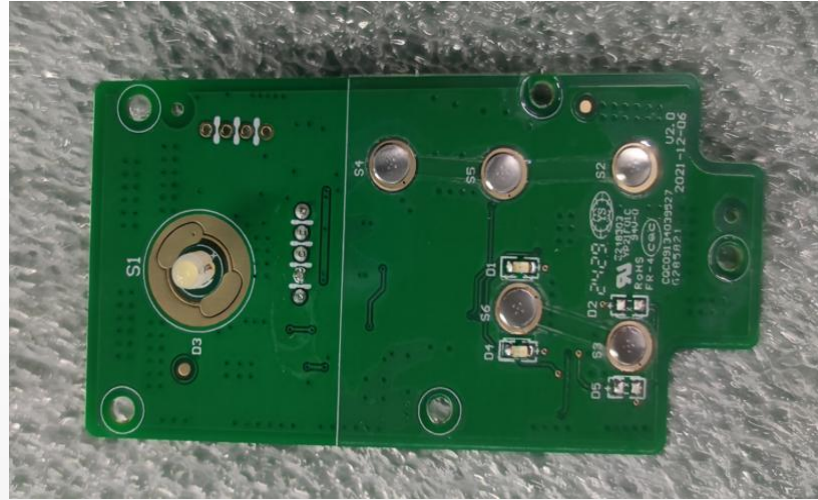

side panel button board

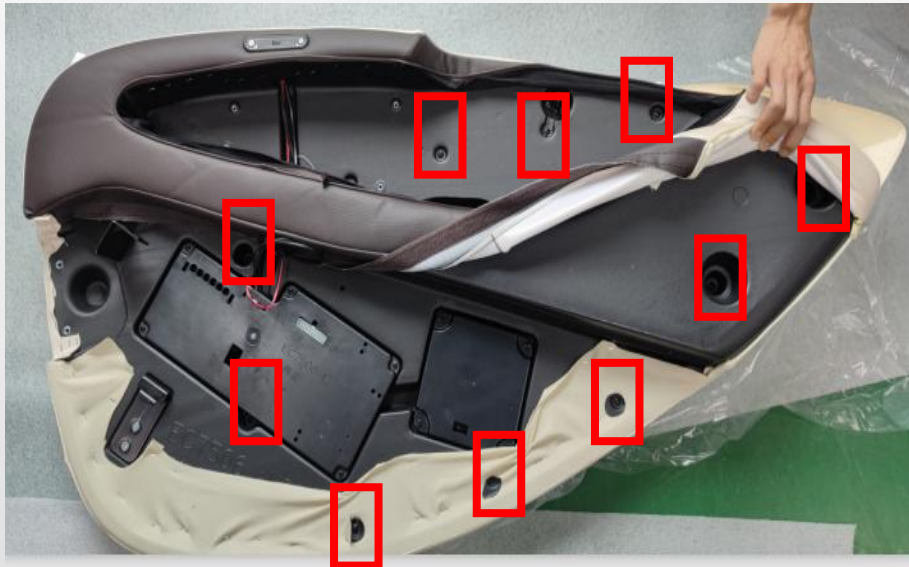

R.remove 10 screws



side panel decorative parts

5、 disassembly of left side panel:



A.remove 1 screws



B.Lift up the front end of the side panel and then move the entire side panel forward

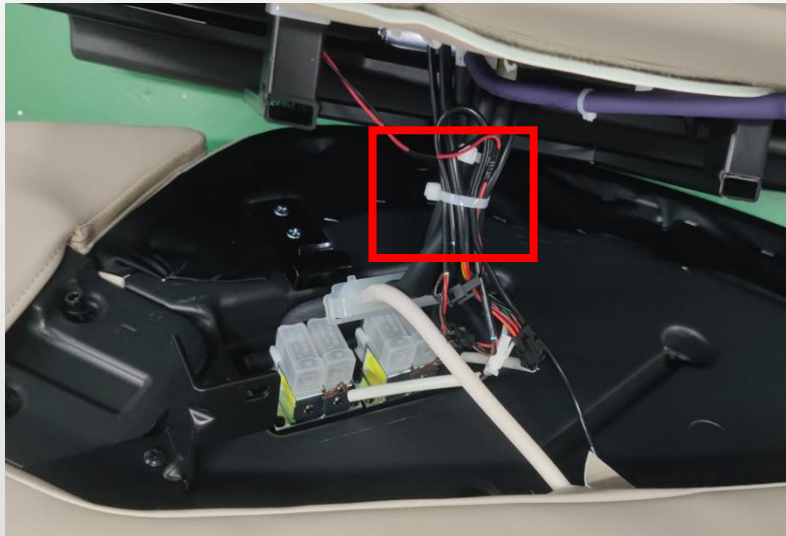

C.cut off the zip ties

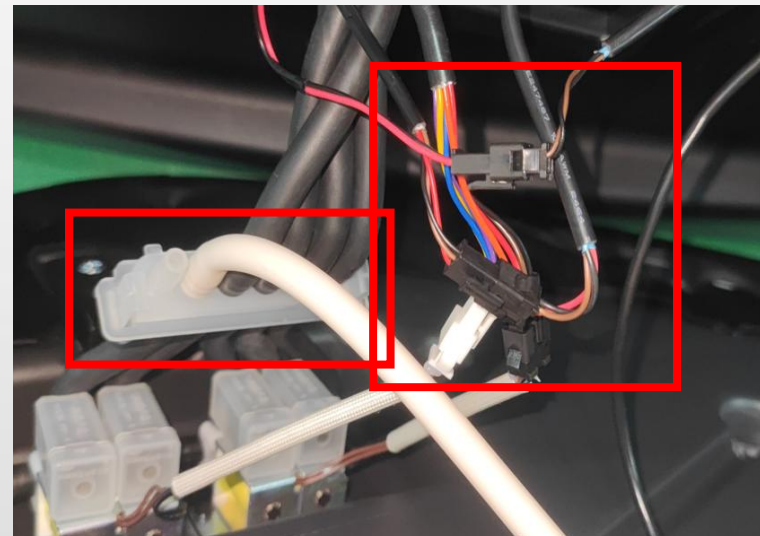

D.disconnect the terminal and air hose



left side panel

6、 disassembly of inner left side panel:



A.remove 2 screws



Side panel baffle



B.remove 8 screws,remove the trachea

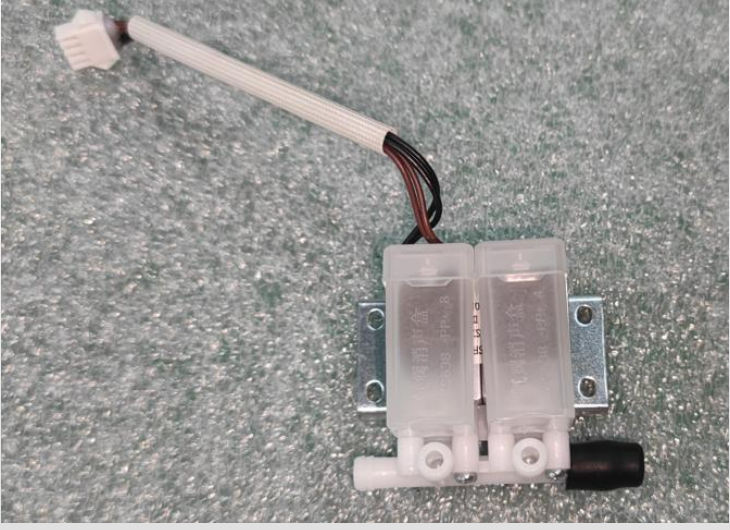
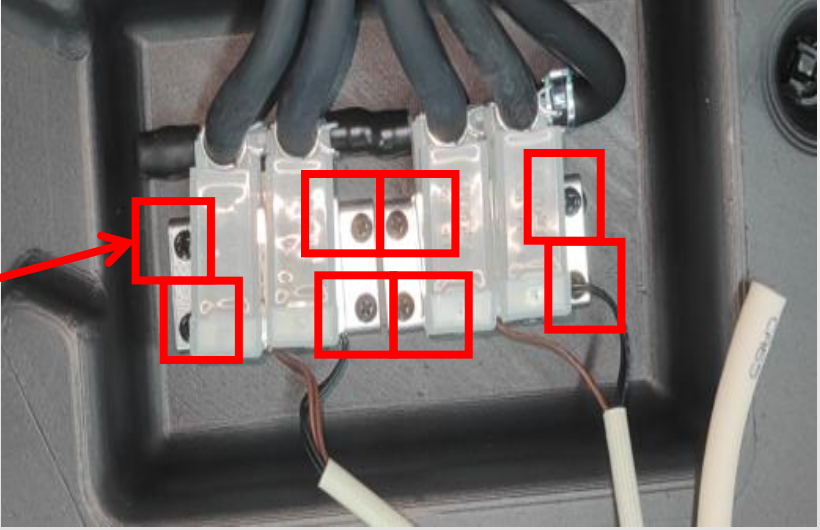

air valve component

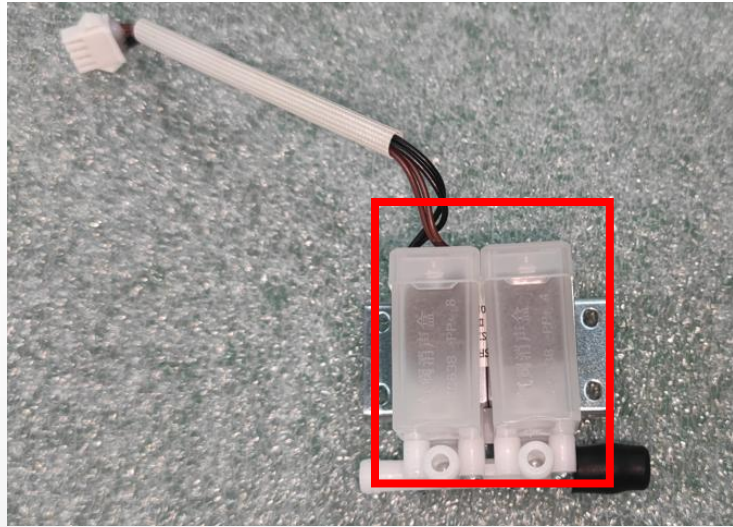

C.remove 2 screws



air valve



air valve silencing box component



D.unzip the zipper

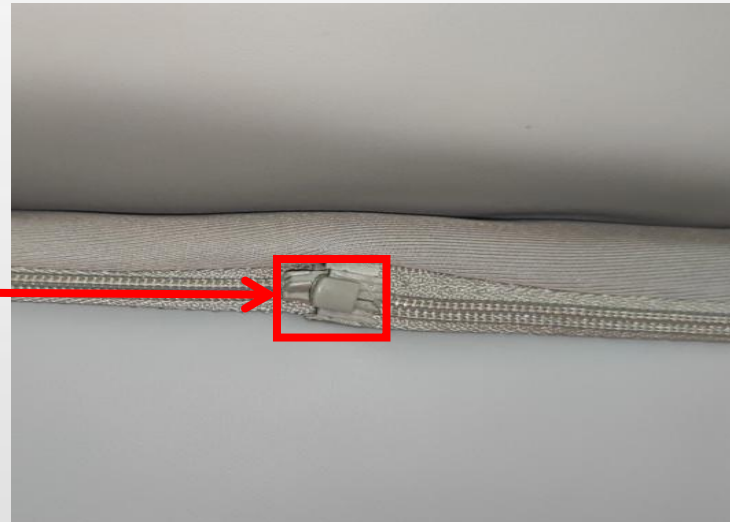



E.cut off the zip ties,remove 4 screws

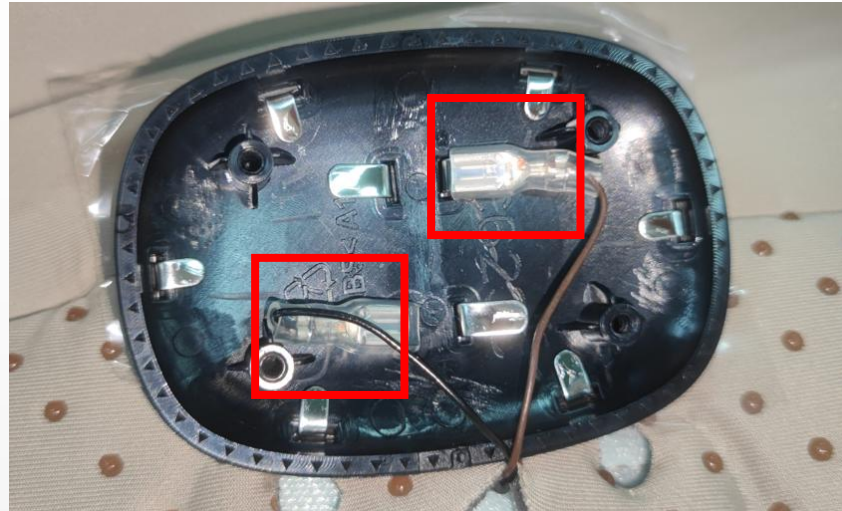

F.disconnect the terminal



pain detection



G.break open the cloth cover pin



left armrest leather cover



H.remove 1 screws

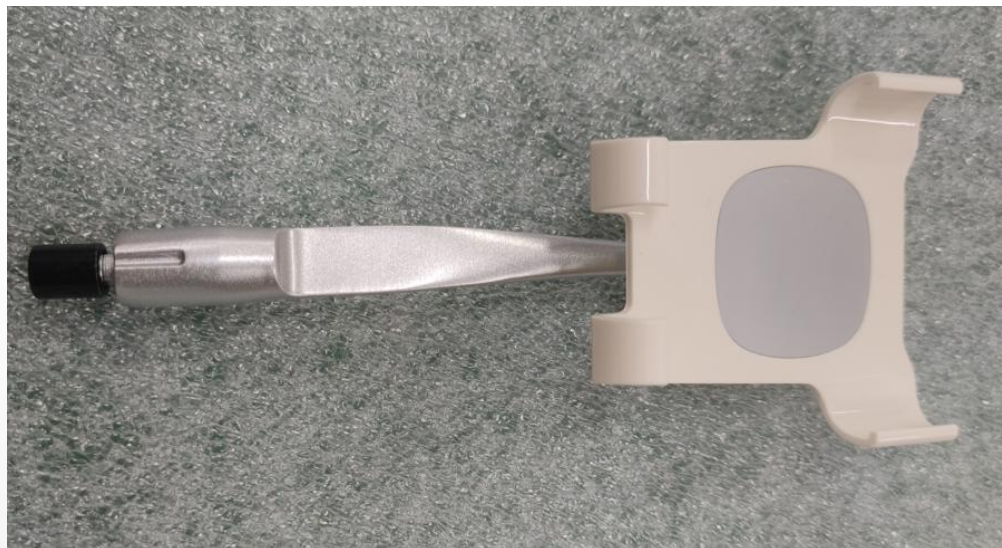

hand controller bracket assembly

7、disassembly of the pad control and pain detection:

A. remove left side panel (refer to disassembly of left side panel)

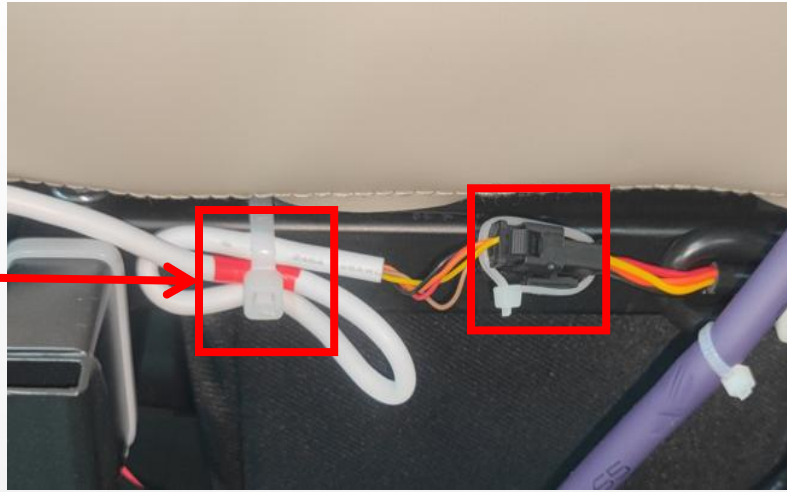

B. cut the cable tie, disconnect the terminal

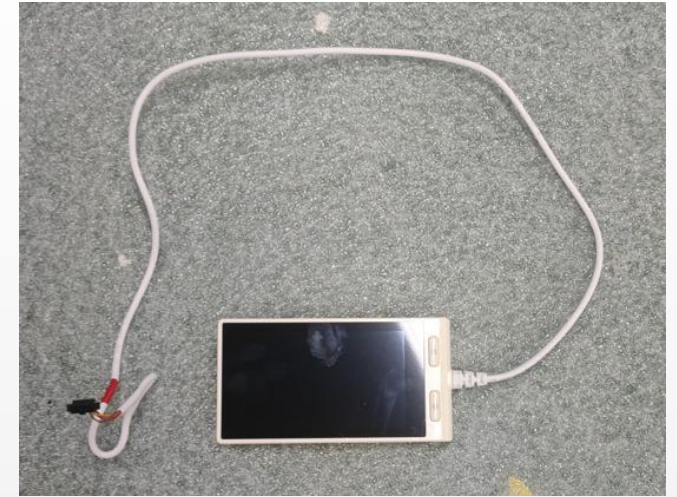

8、disassembly of side seat:

A. remove left side panel and remove right side panel (refer to disassembly of left side panel)

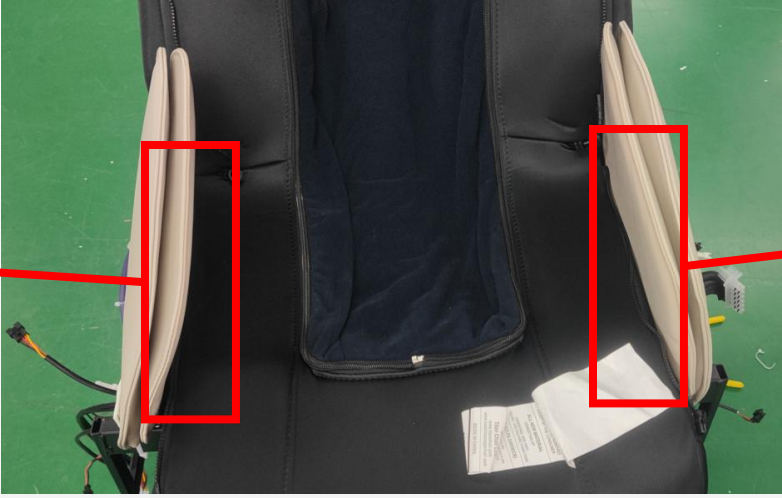
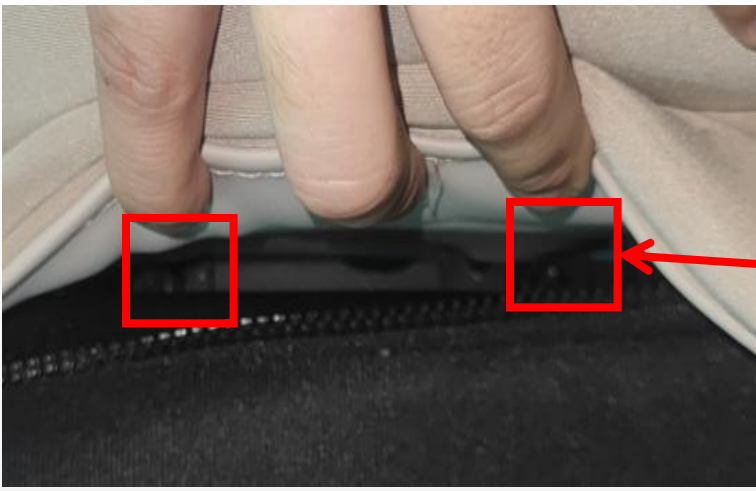

B. remove 4 screws

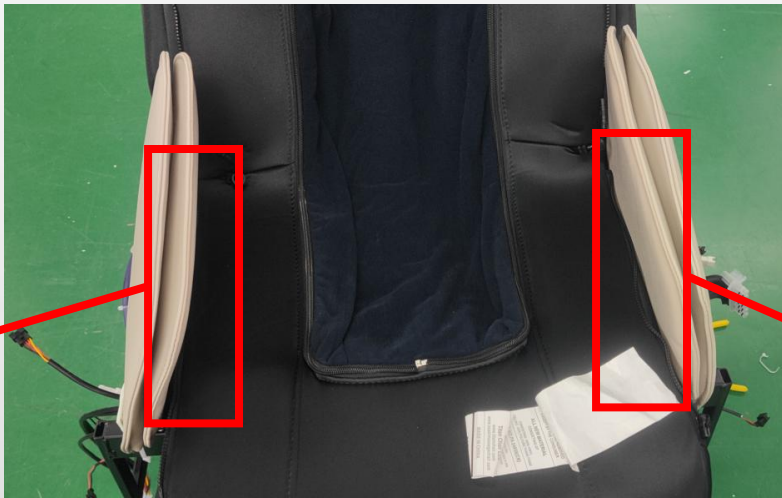
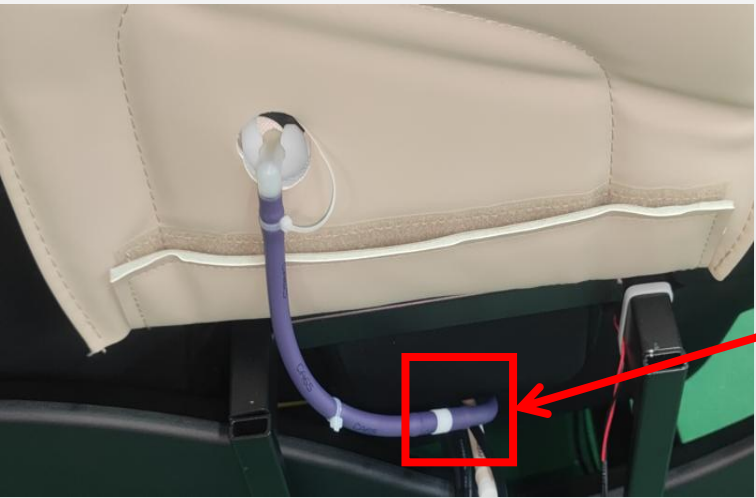

C. discontent the air hose



D. tear open the sticky button



E. remove the baffle



F. remove the airbag



seat side leather cover



seat side airbag

9、 disassembly of the hood:



A.open the shoulder leather cover zipper and remove the 4 fixed screws

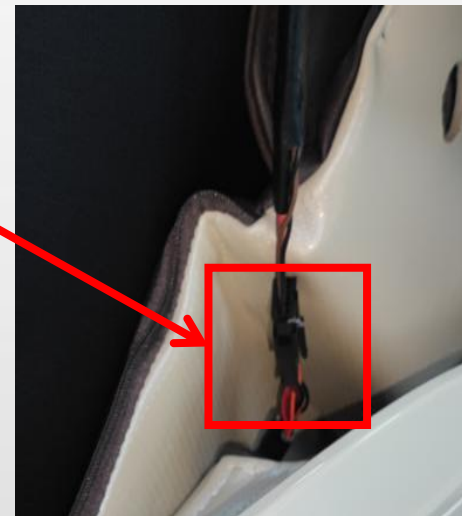

head cover component

B.disconnect the connecting wires on both sides to remove the hood assembly

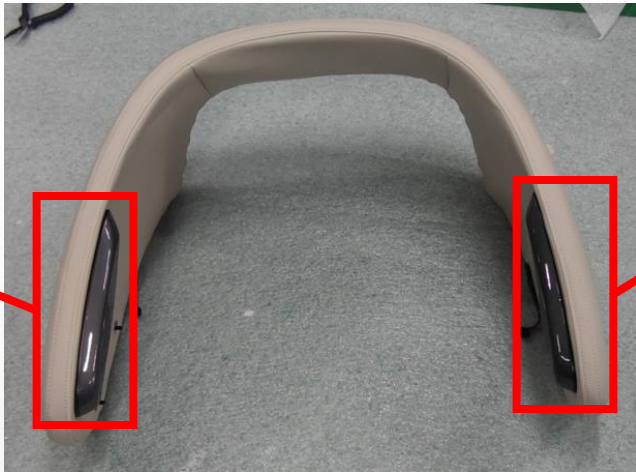

C. tear off the outer cover of the horn



D. tear off the adhesive

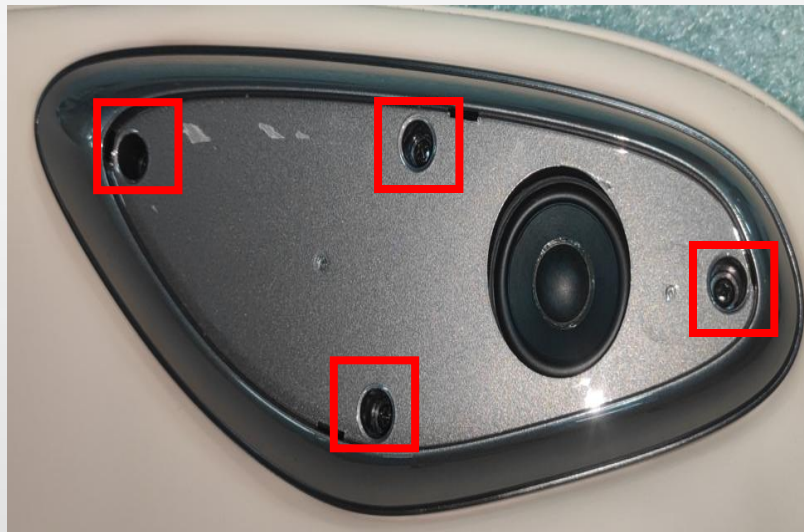

E. remove 4 screws



speaker component

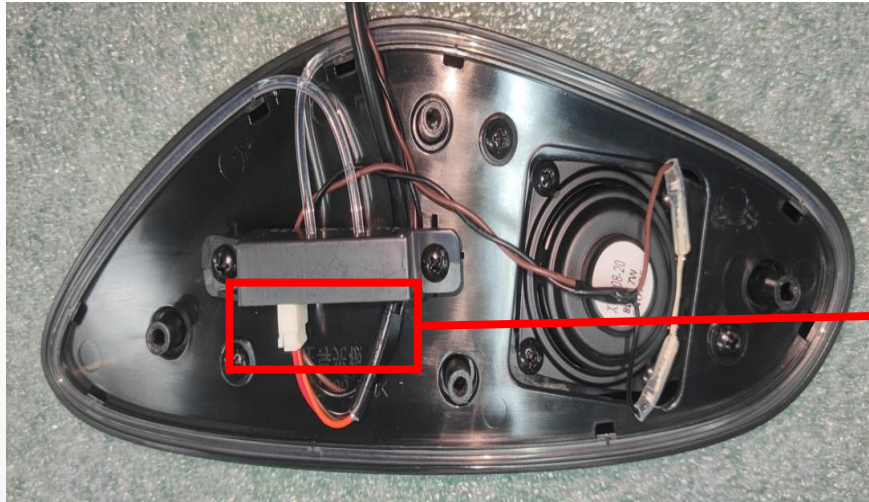

F.disconnect the connecting wires,remove 4 screws

LED PCBA

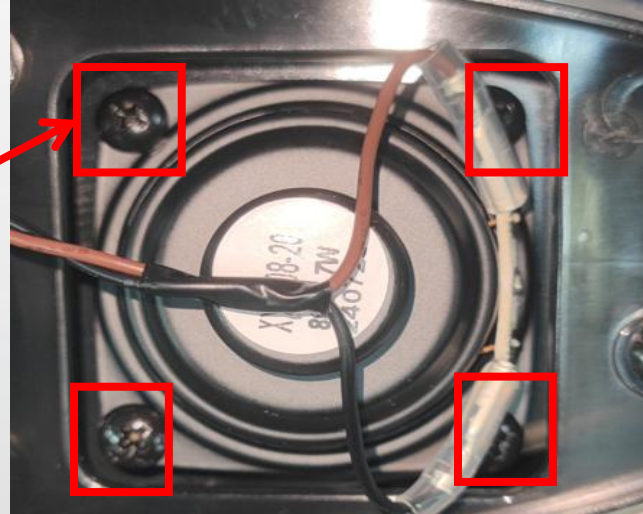
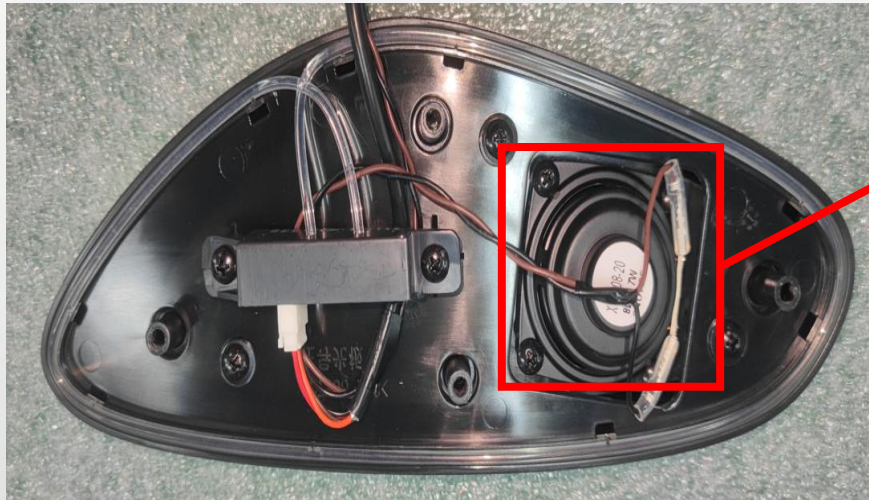

G.disconnect the connecting wires,remove 4 screws

horn



H.unzip the zipper



head cover leather case

10、 disassembly of the shoulder:

A. remove hood (refer to disassembly of the hood)

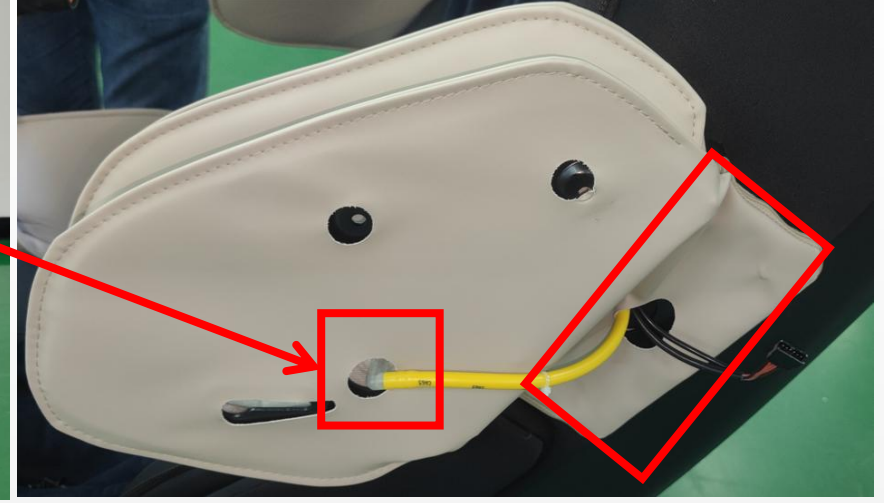
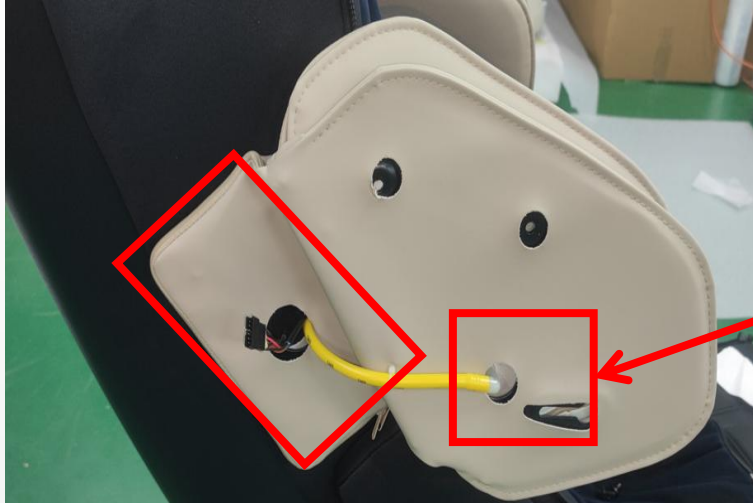

B. disconnect the trachea and unzip it

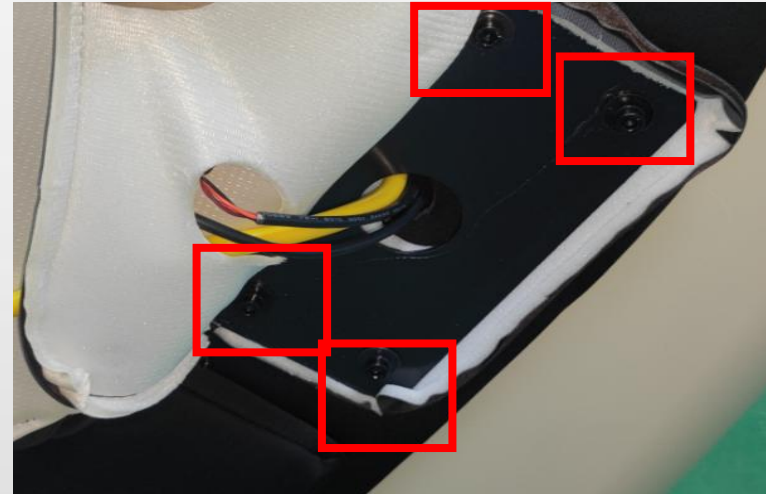
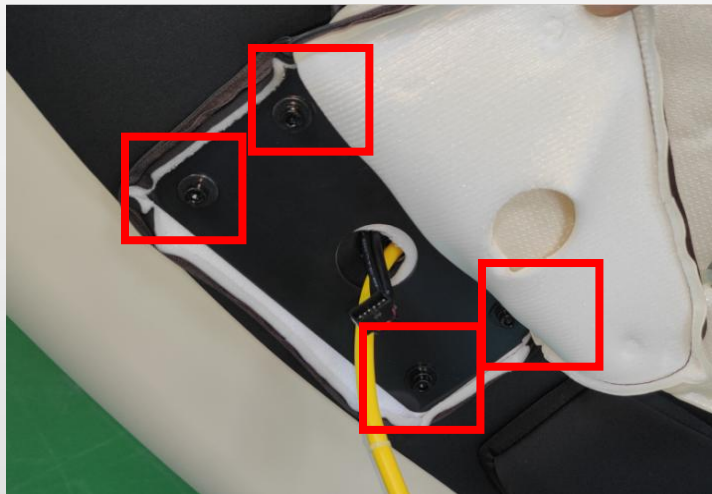

C. disconnect the connecting wires,remove 4 screws

shoulder components



D.open the shoulder leather cover to replace it

shoulder leather cover

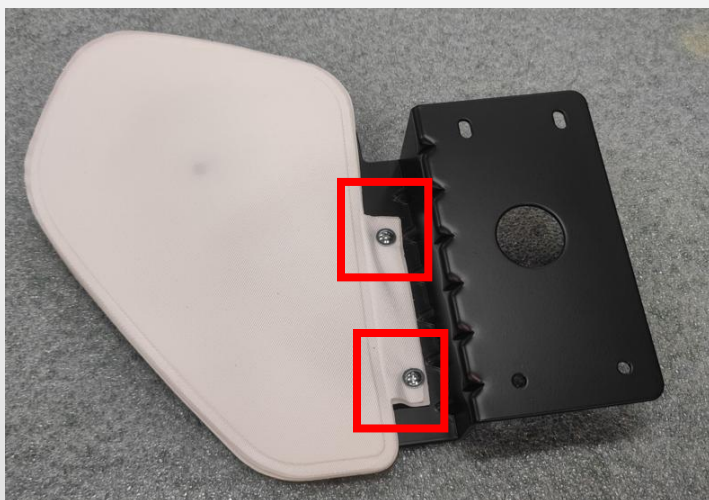

E.remove 4 screws

shoulder airbag

11、disassembly of the backrest cable:



A.remove 4 screws



rear cover

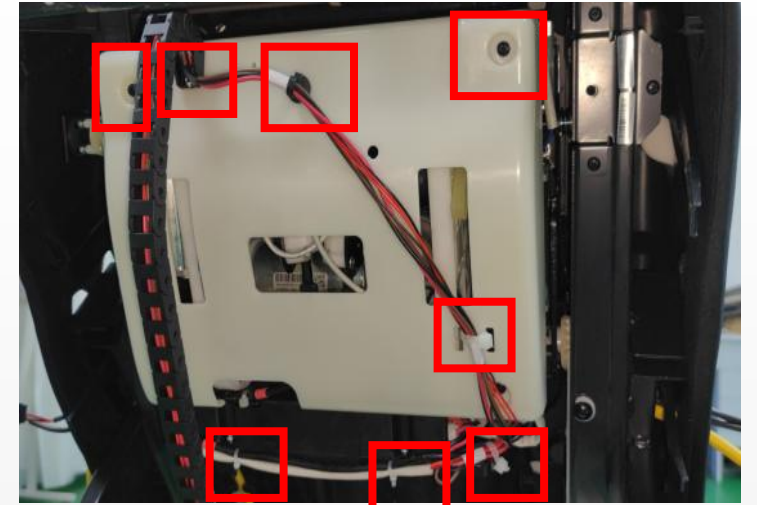

B.remove the 2 fixing screws of the track and the 2 screws of the back cover of the movement, and cut off the buckle

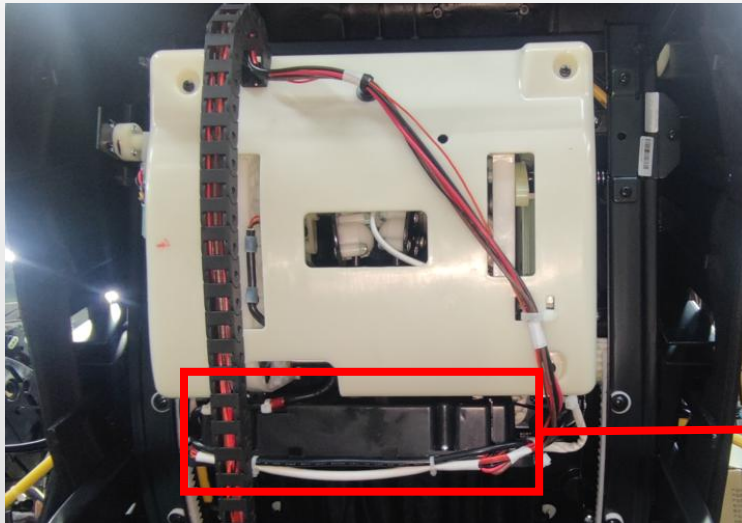

C.remove 3 screws

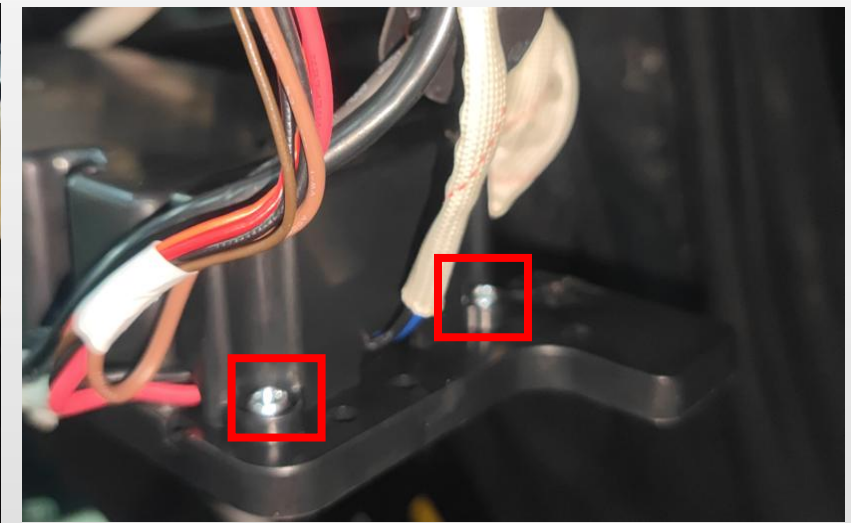
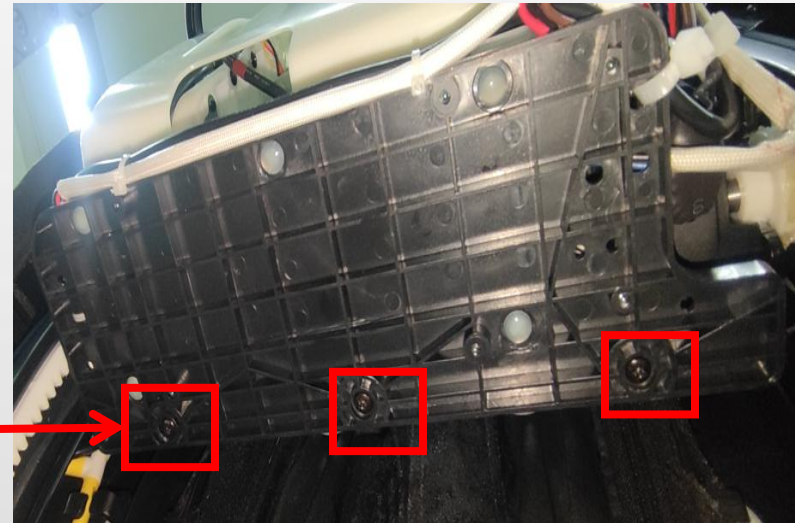

D.remove 2 screws



E.remove 2 fixing screws and 1 ground screw from the track, cut off the tie buckle, and disconnect the connecting wire

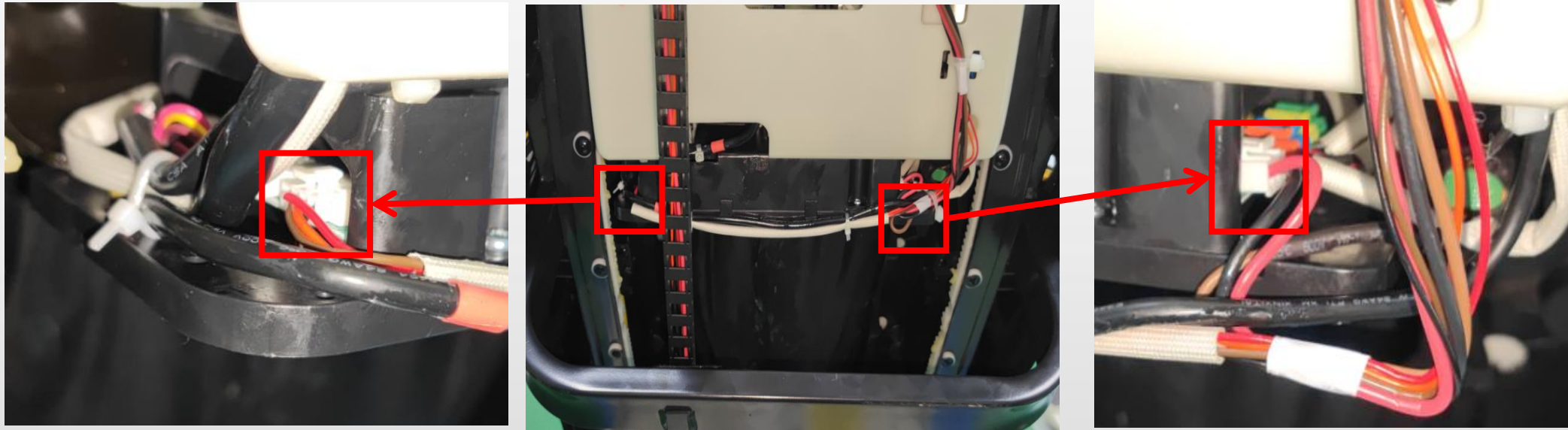

F.unplug both terminals

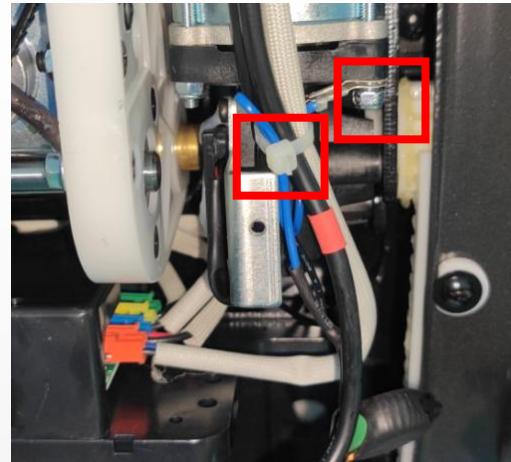
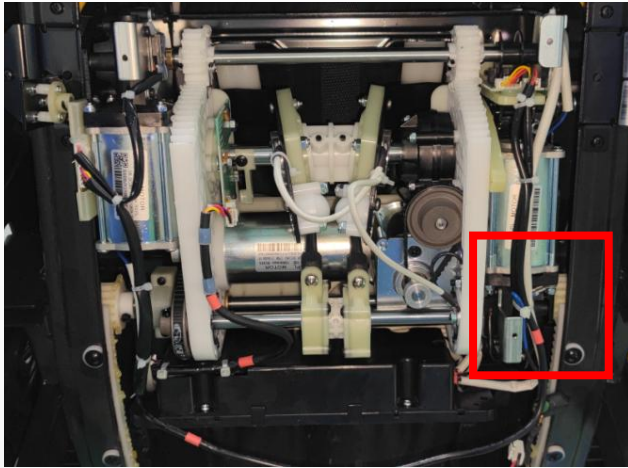

G.cut off the buckle and remove the fixed ground wire nut to replace the backrest core wire

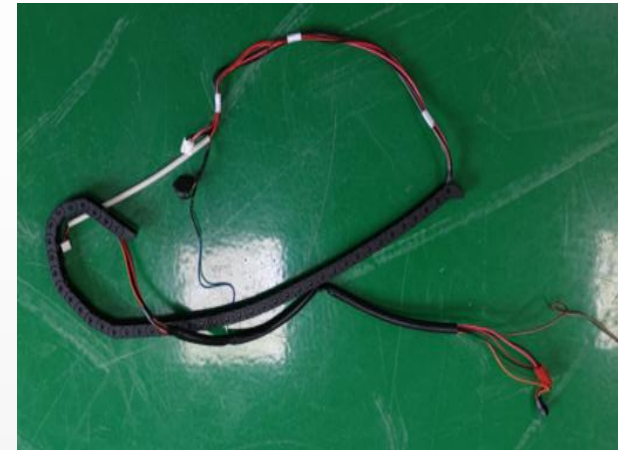

backrest cable

12、disassembly of the Gearbox:

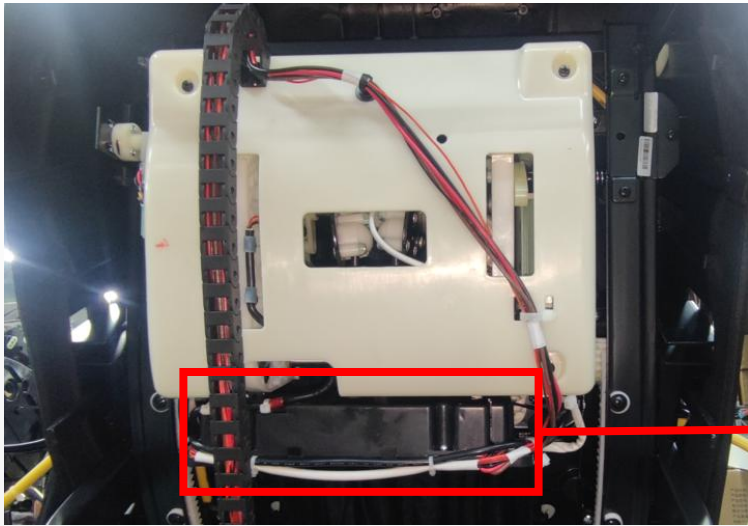

A.remove 3 screws

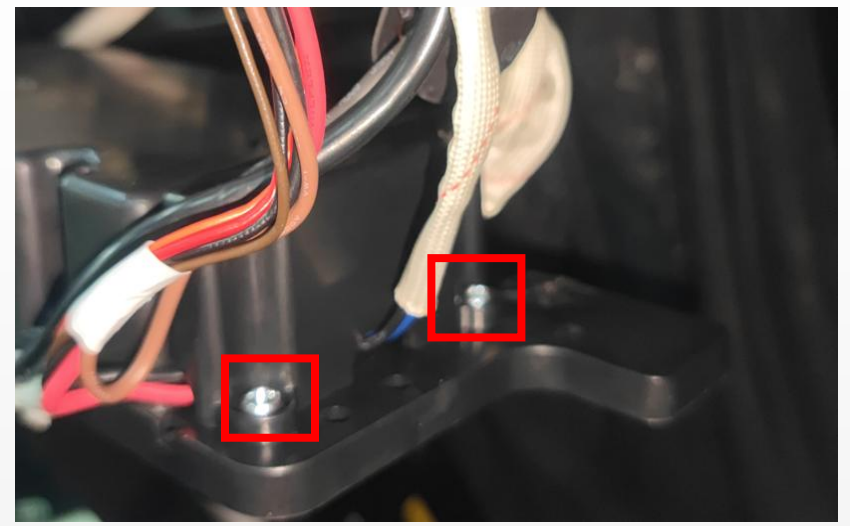
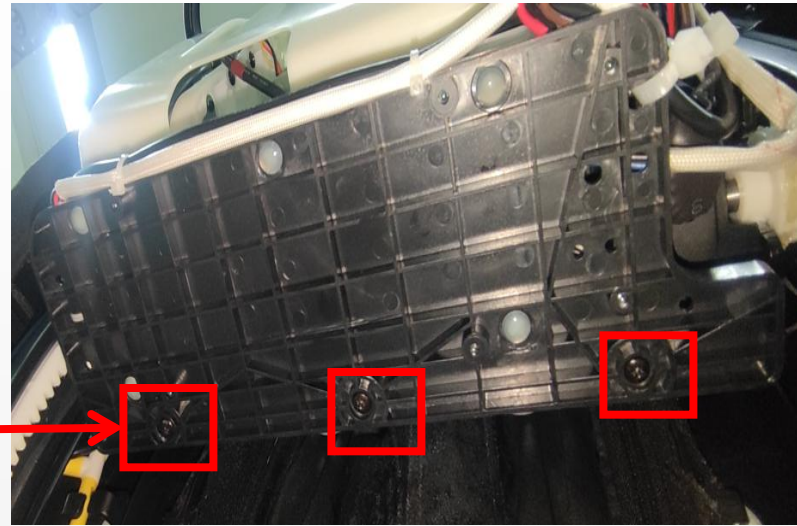

B.remove 2 screws

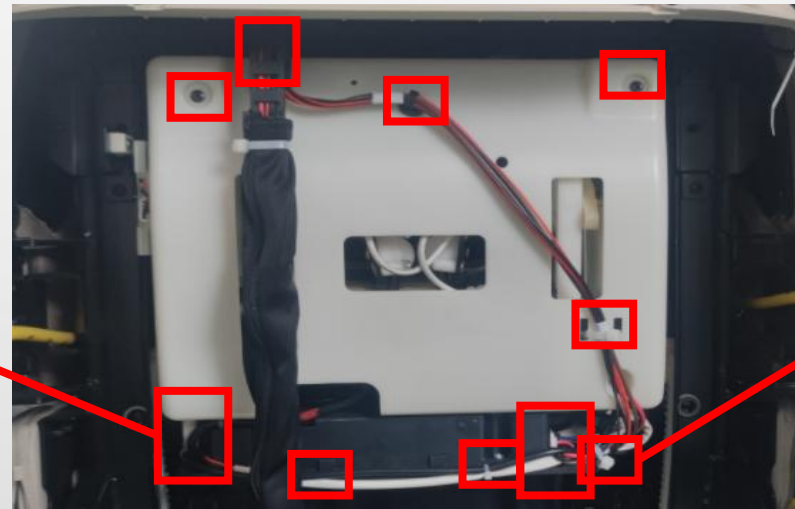
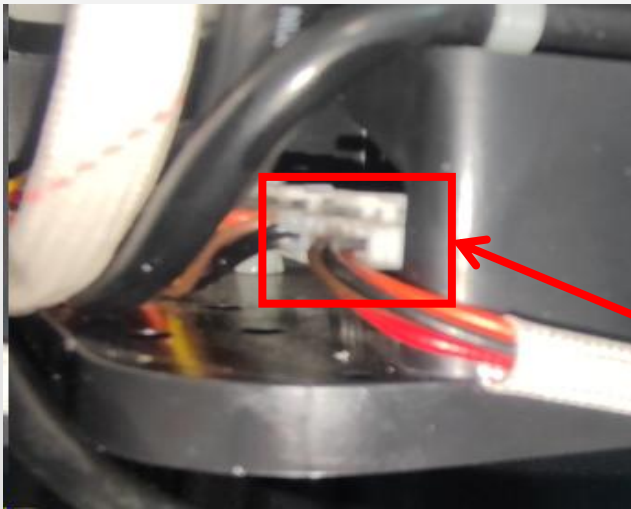

C.remove the screws, cut cable tie



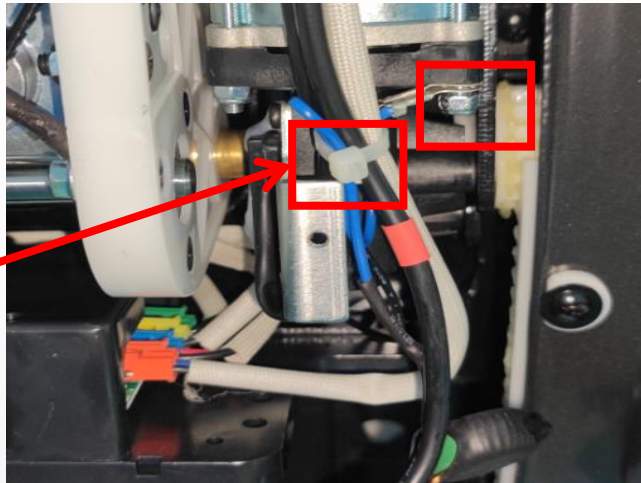
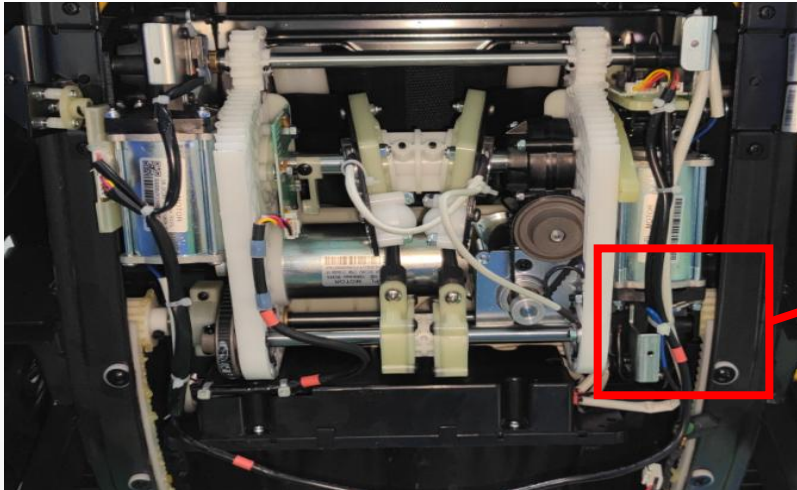

D. cut off the buckle and remove the fixed ground wire nut to replace the backrest core wire

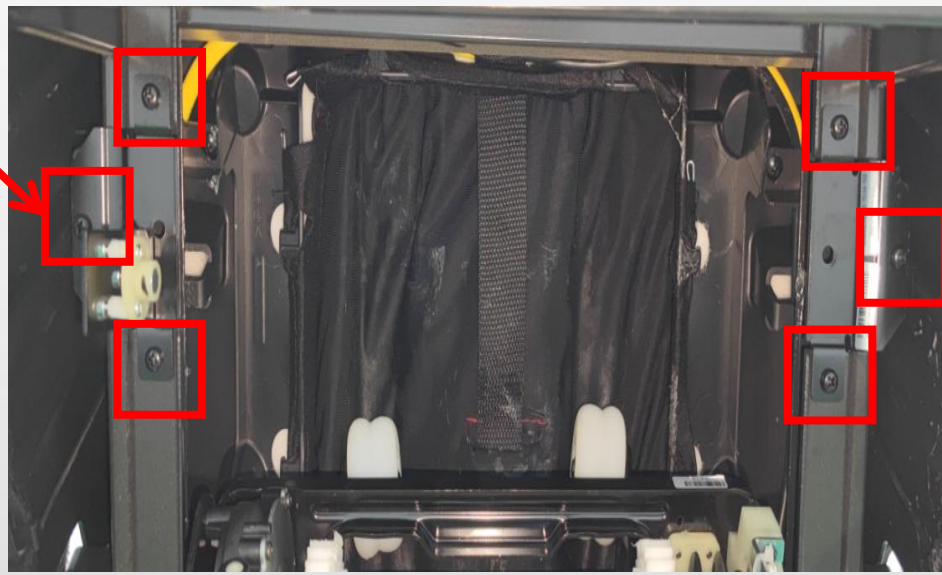
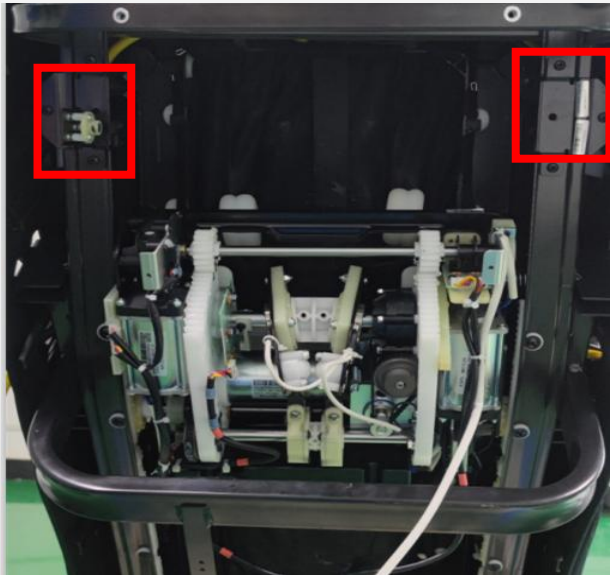

E. remove 6 screws

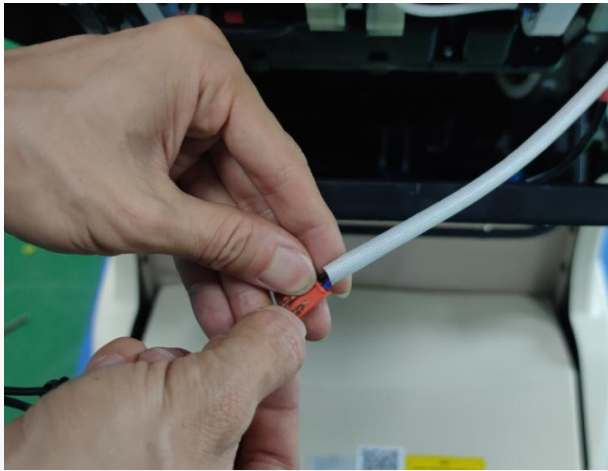

F. Use 24V to remove the movement

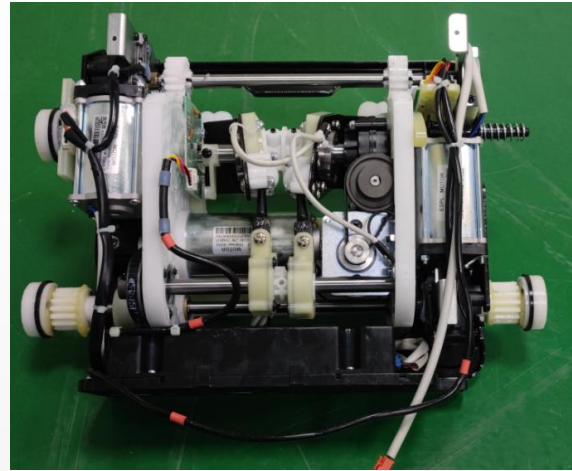

Gearbox

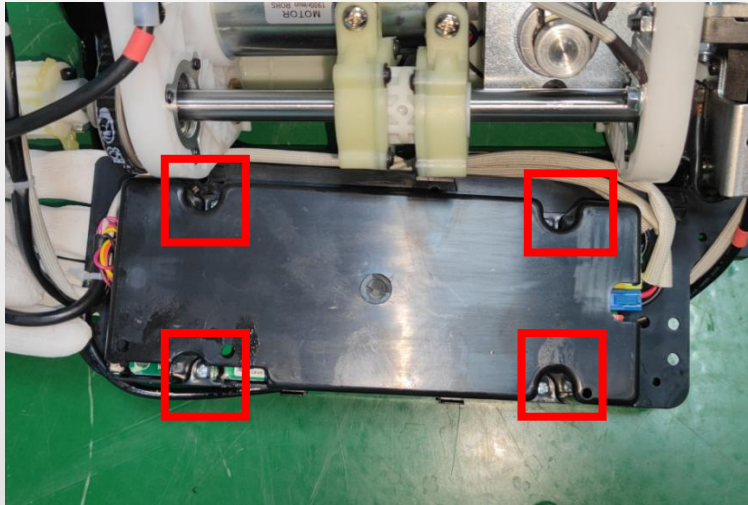

G. remove 4 screws

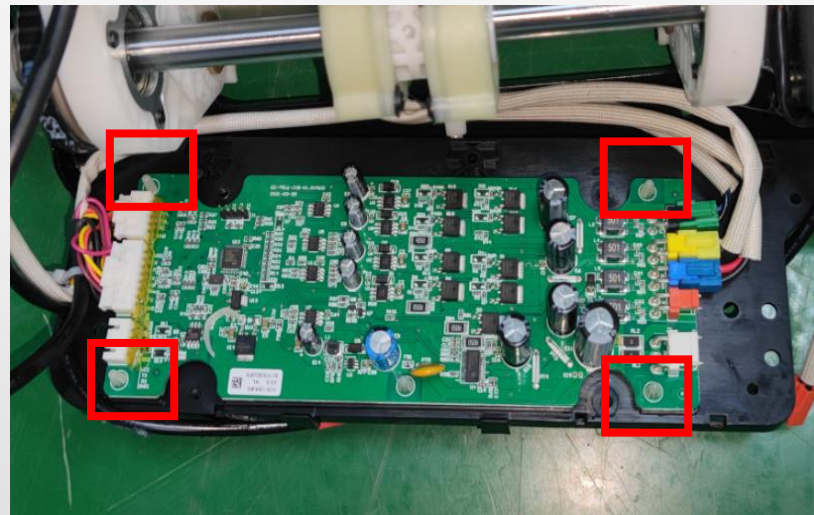

H. Unplug all terminals and remove the aircraft rack to replace it



Gearbox PCB

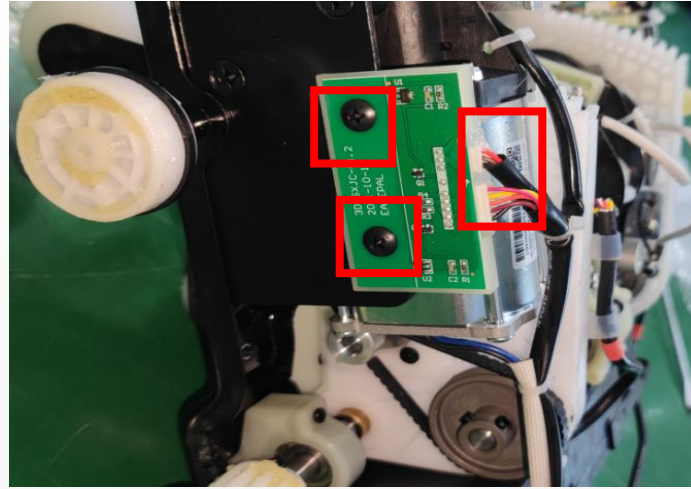
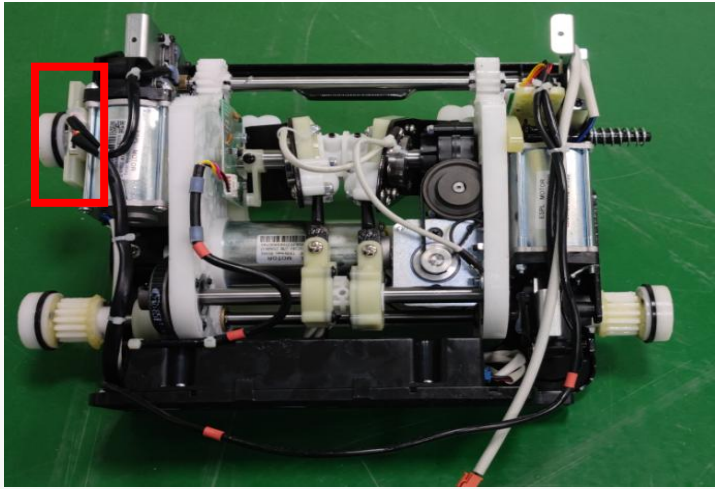

I. Unplug the terminal and remove the fixing screw to replace the up and down travel board

Up and down travel board

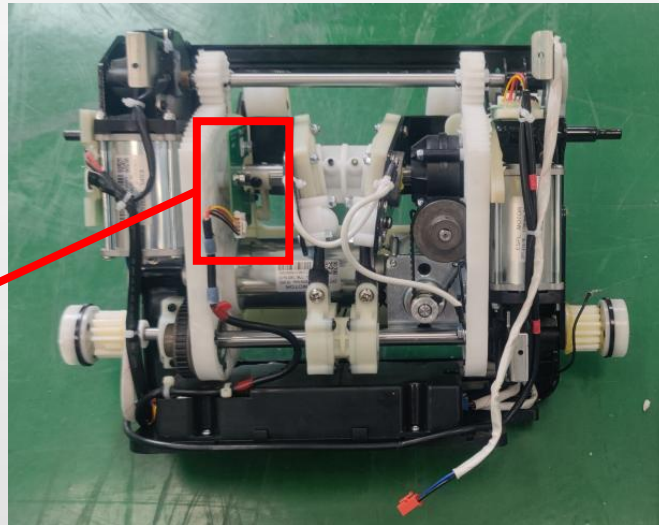
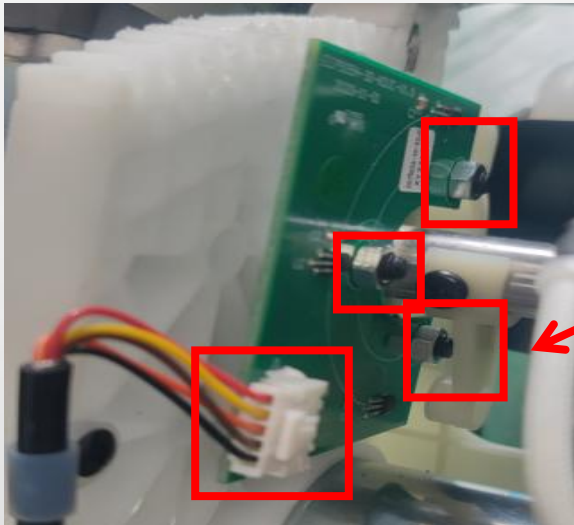

J. disconnect the terminals, remove the 3 screw

13、 disassembly of the underseat PCB :



A.remove 4 screws

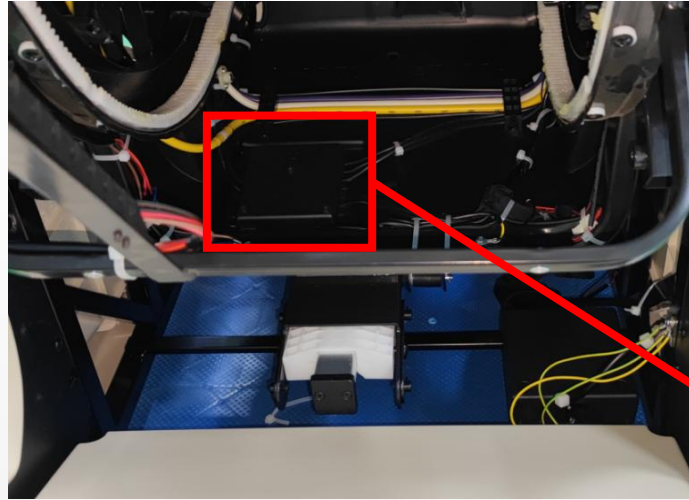

B.remove 4 screws

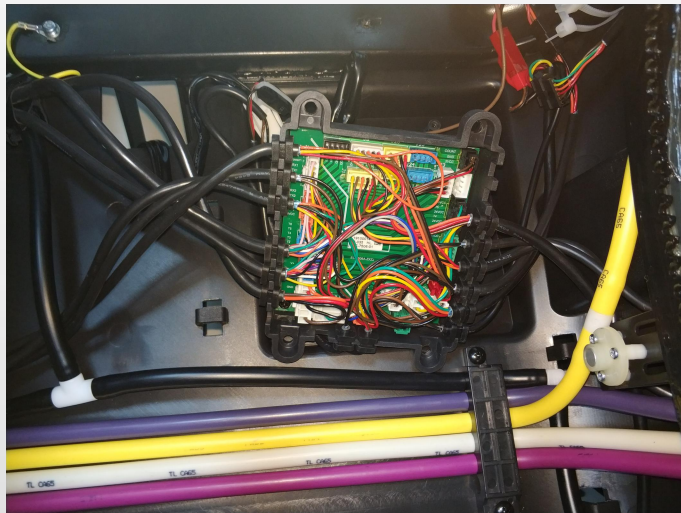
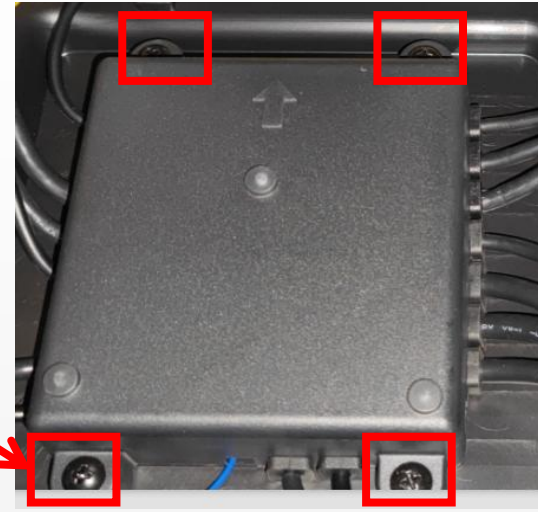

C.Unplug the terminal and remove the screw to replace the adapter board under the seat

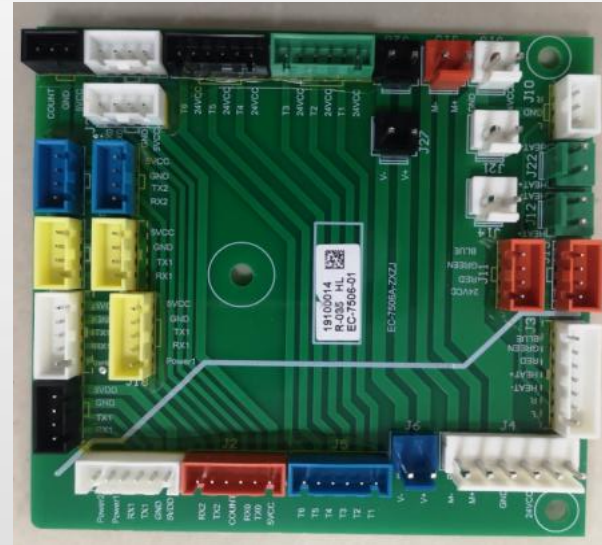

underseat PCB

14、 disassembly of the main PCB box:

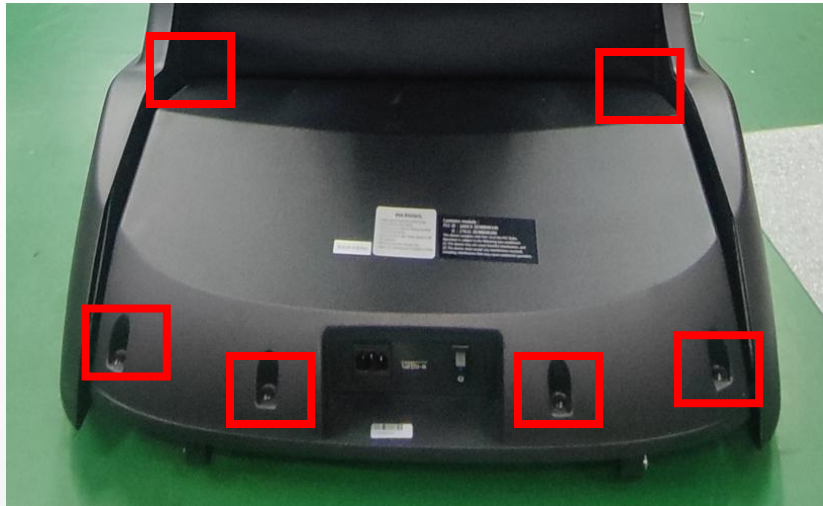

A.remove 6 screws, open the main PCB box



main PCB box cover

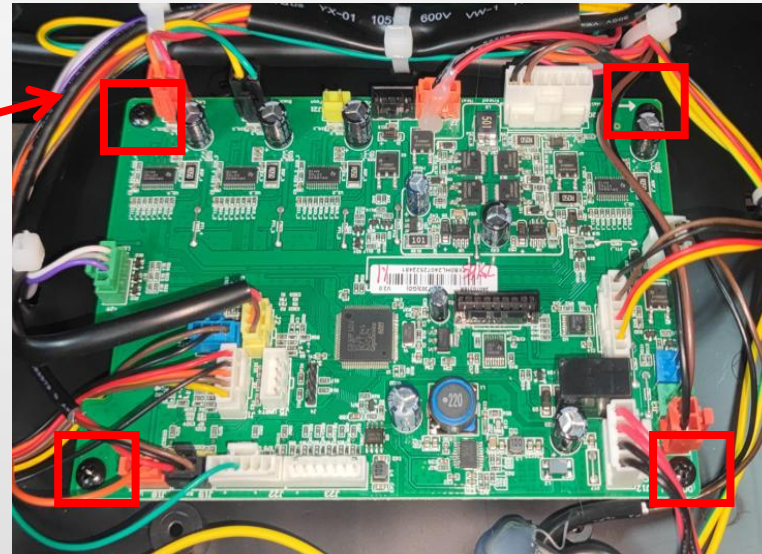

B.disconnect the terminals, remove 4 screws

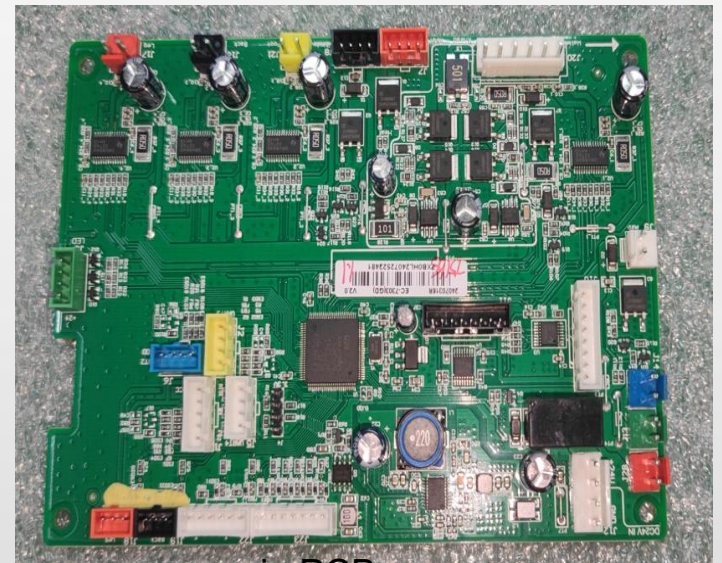

main PCB

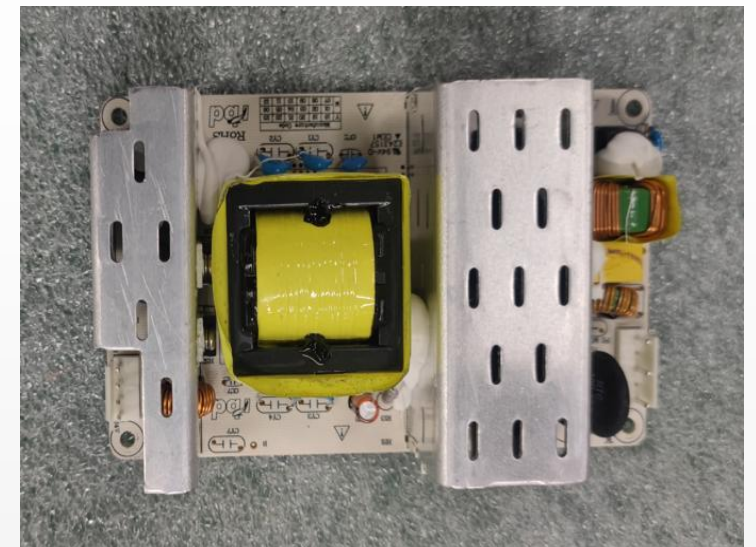
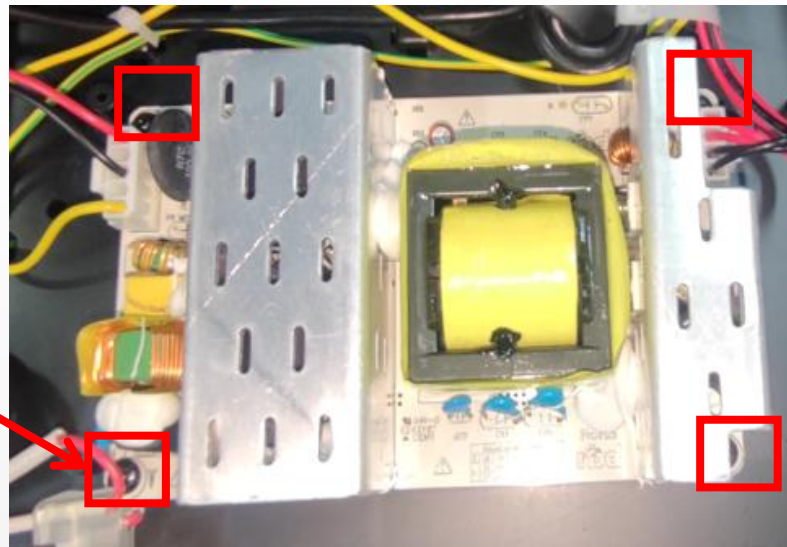

C.disconnect the terminals, remove 4 screws

power PCB



D.remove 5 screws

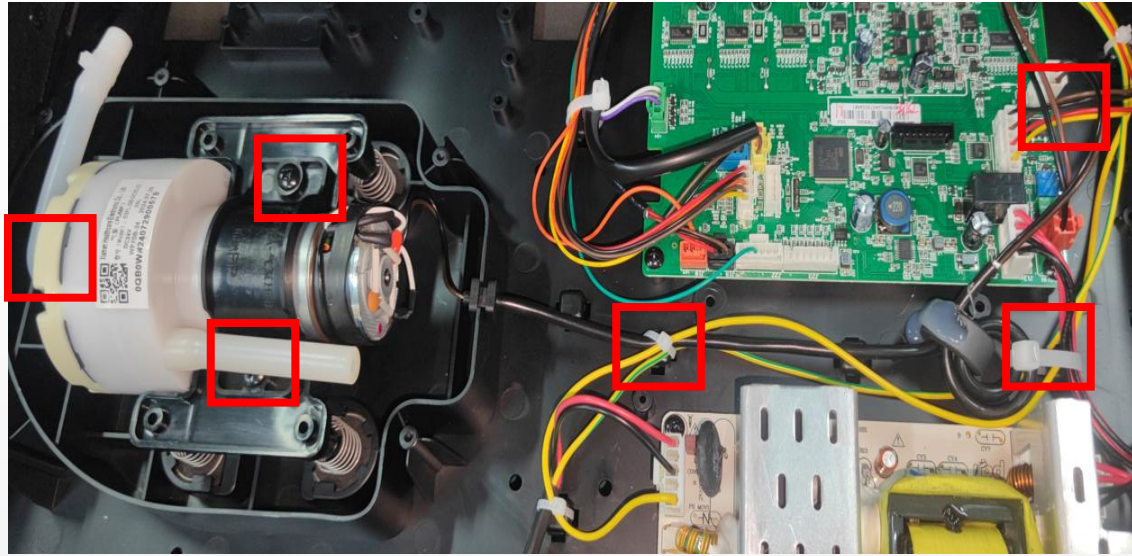

E.Remove the trachea and terminals, cut off the buckle, and take off the 2 fixing screws to replace the air pump



air pump

15、 disassembly of the legrest:

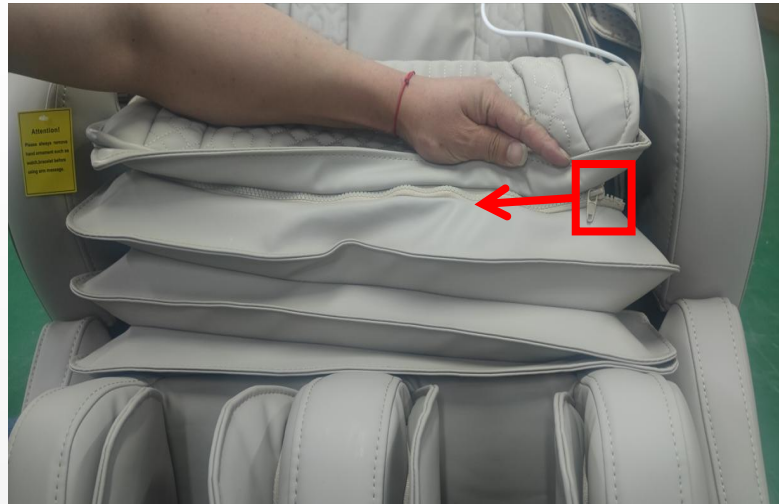

A.unzip the zipper



B.unzip the zipper



C.Remove the blocking on both sides of the legrest



D.disconnect the terminal and air hose
7516E massage chair service guide



legrest

16、decomposition of the upper legrest:

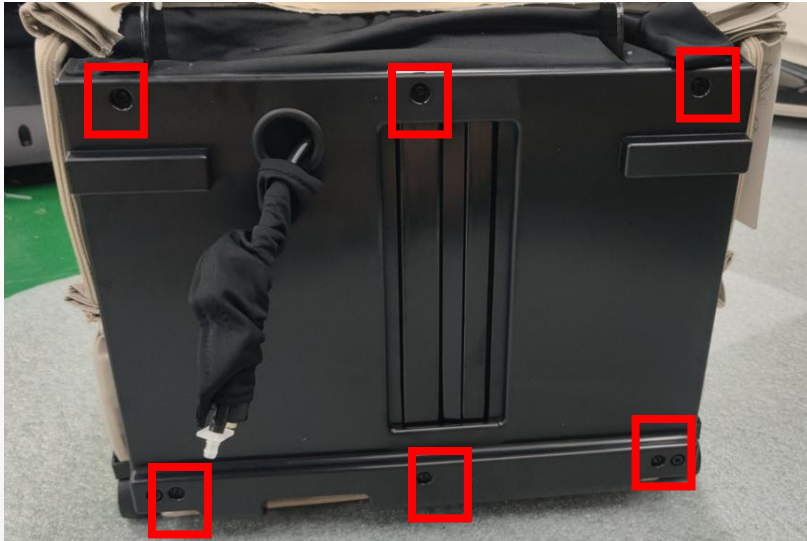

A.remove 6 screws



B.discontent the terminals



Calf back cover

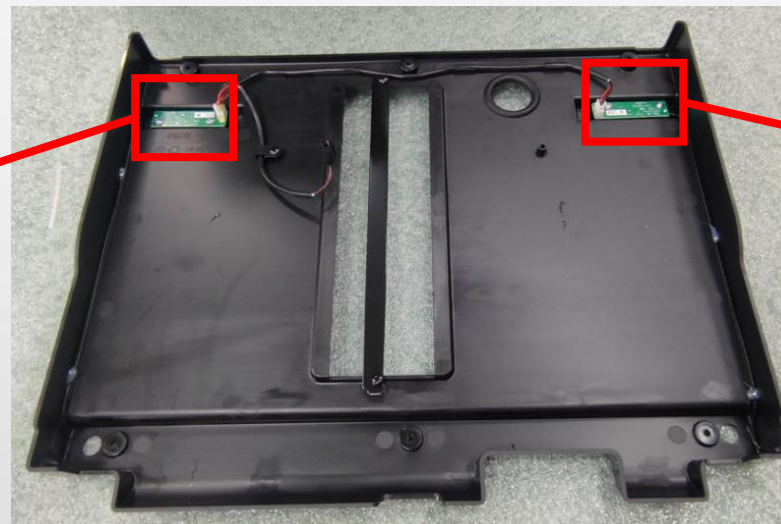
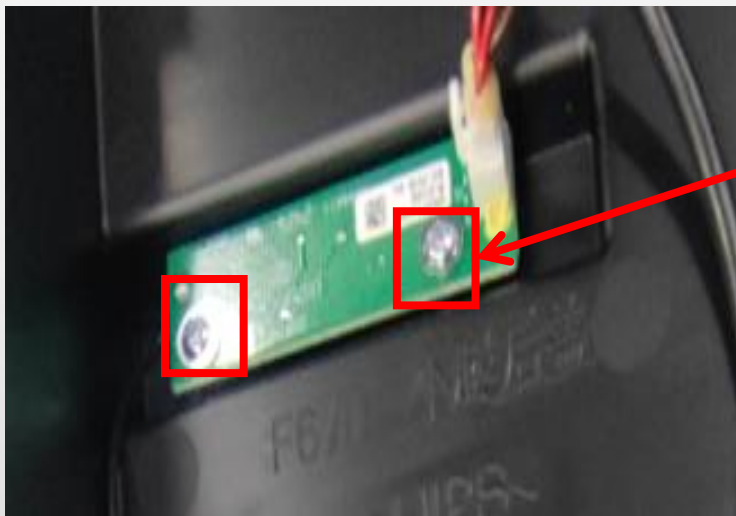

C.Unplug the terminal and remove 4 screws

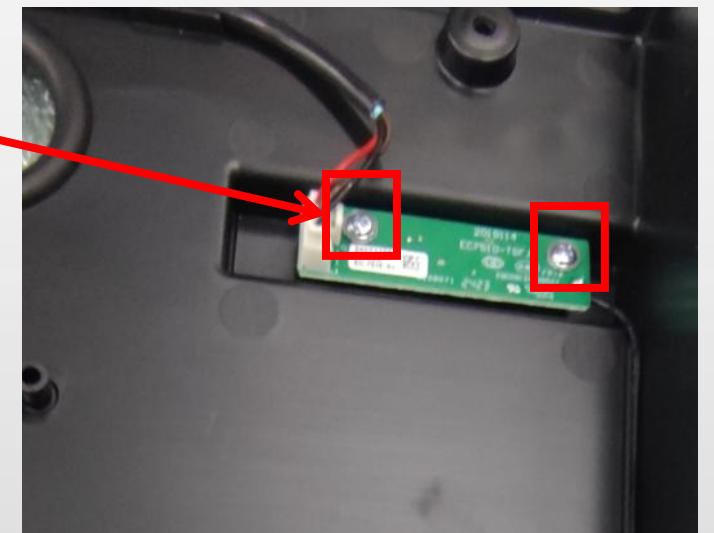

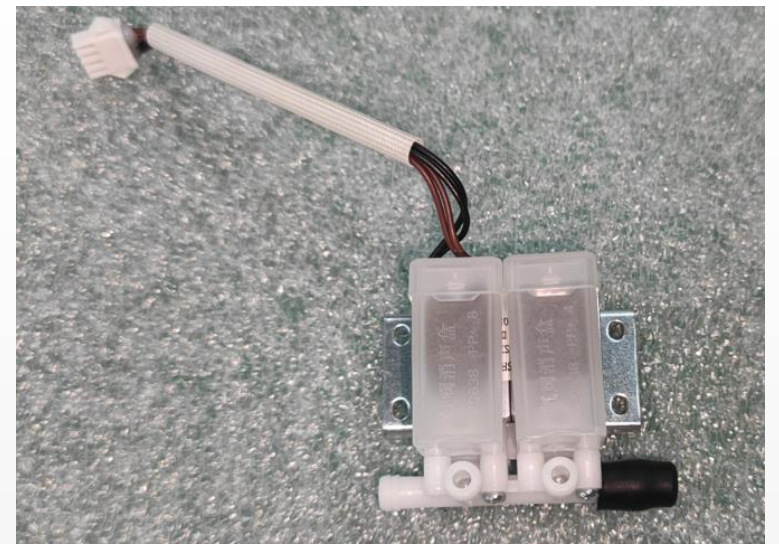
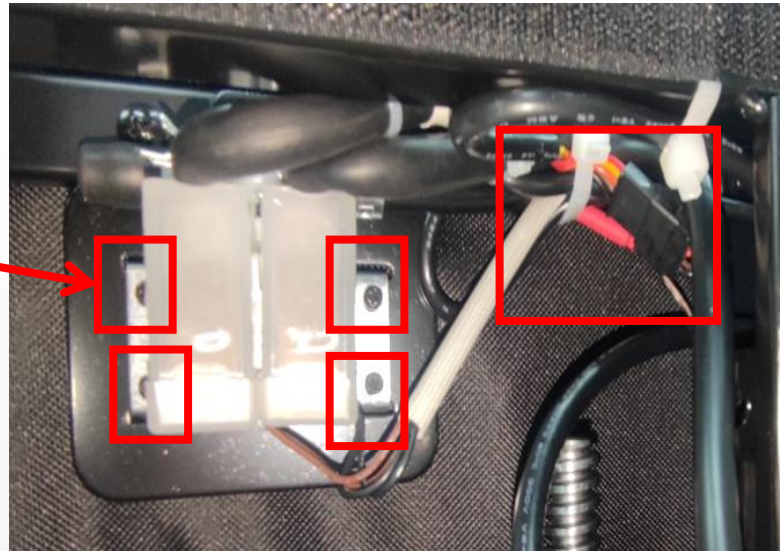
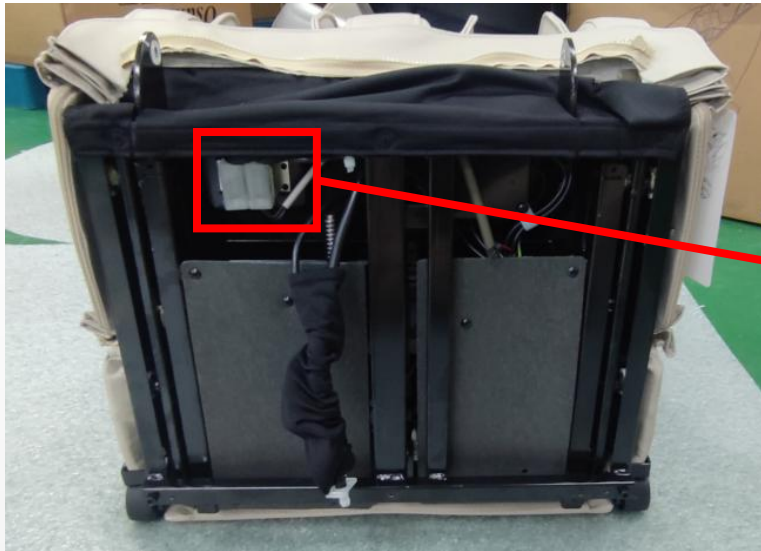

D. Pull out the trachea, disconnect the connecting wire, and remove the 4 fixed screws to remove the air valve

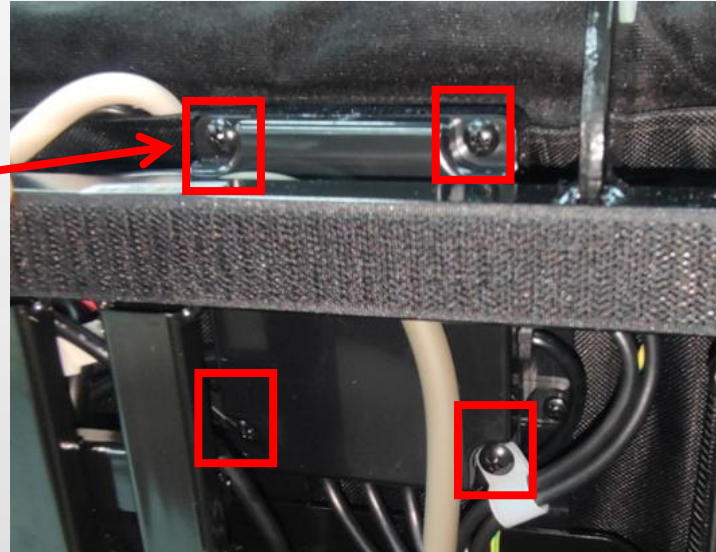
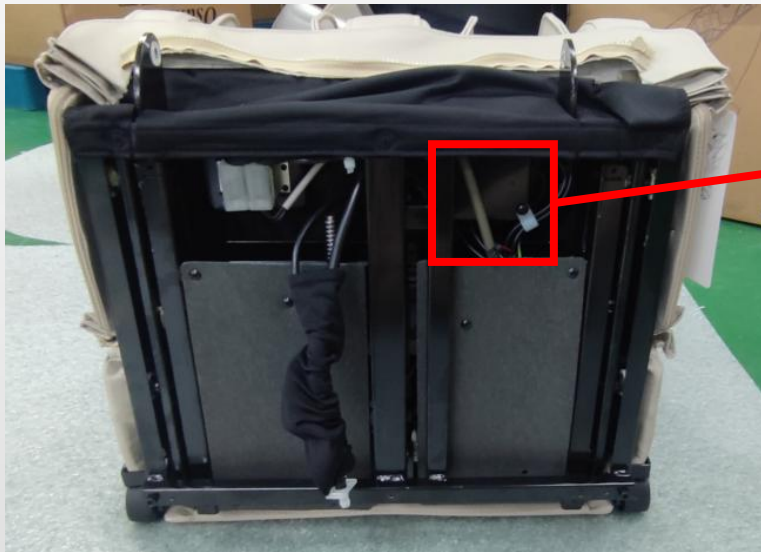

E. remove 4 screws

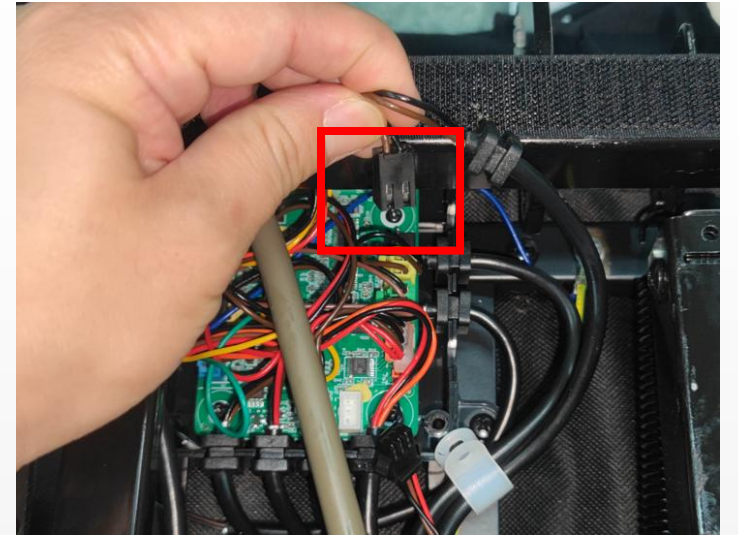
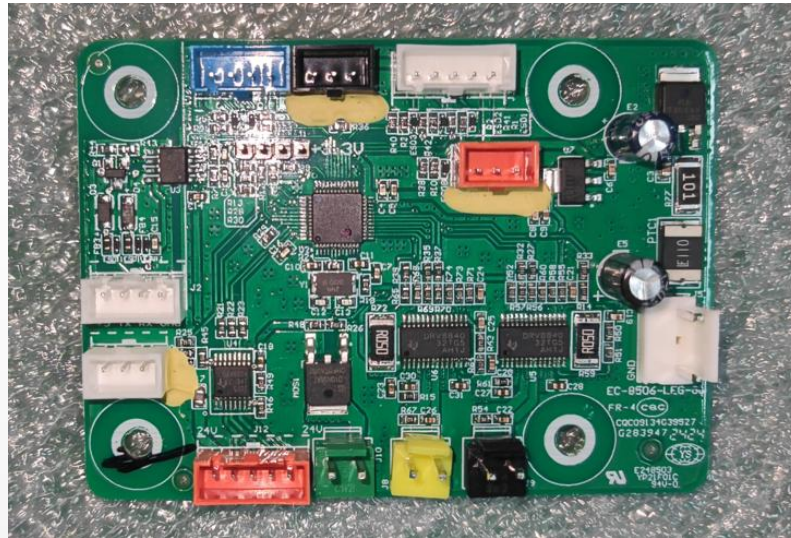
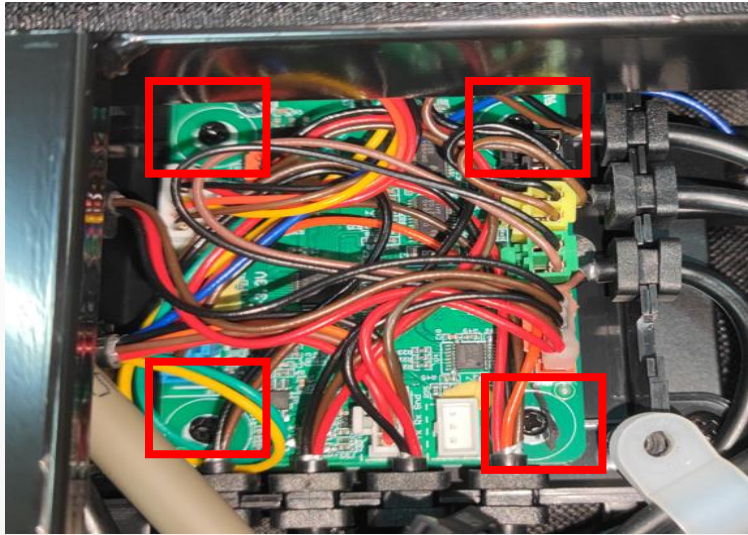

F. Unplug the terminal and remove 4 screws

leg PCB

G. Use 24V to extend the lower leg

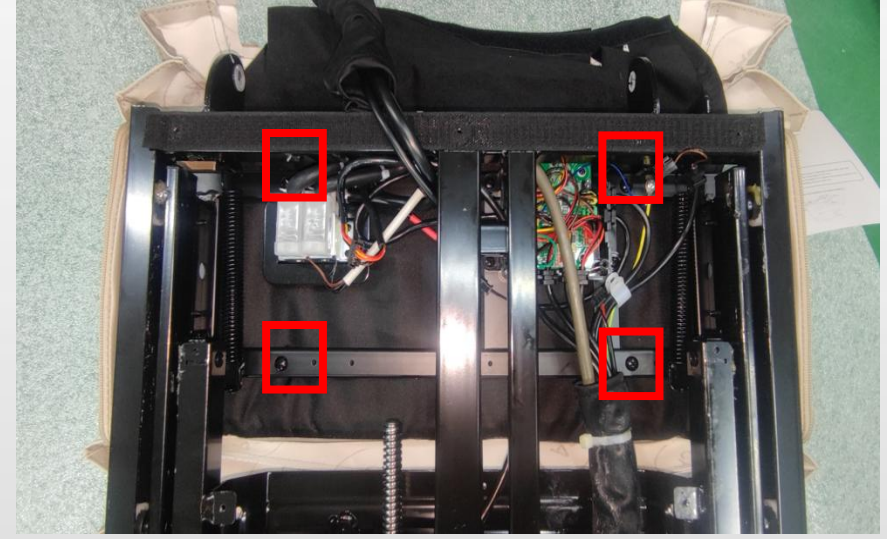
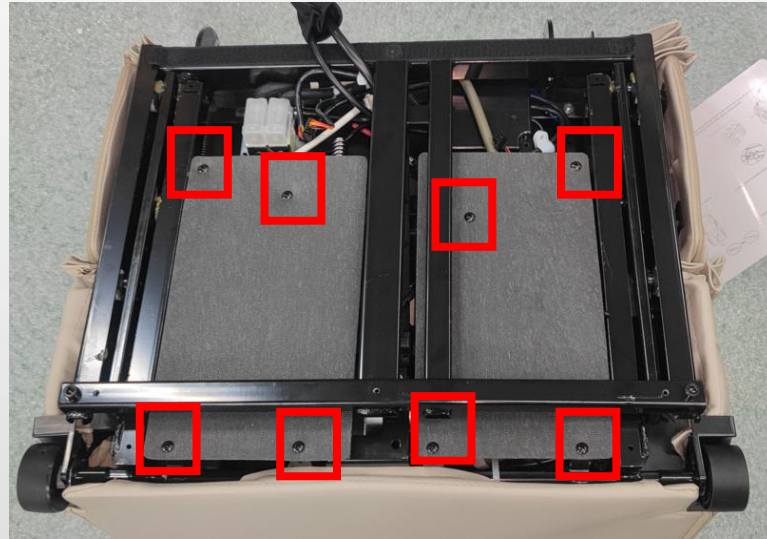

H. unzip the zipper

I. remove 8 screws

J. remove 4 screws

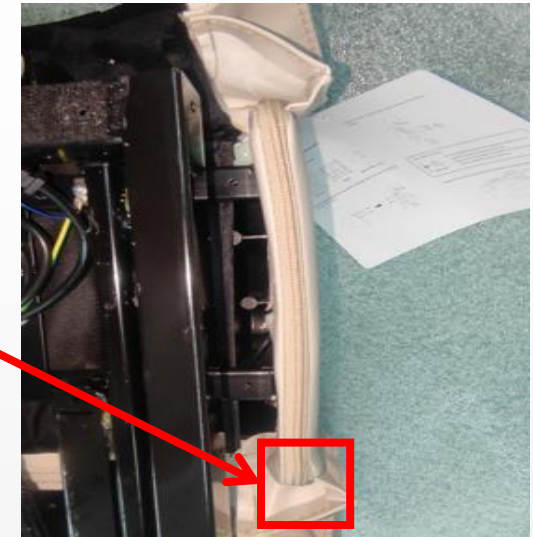
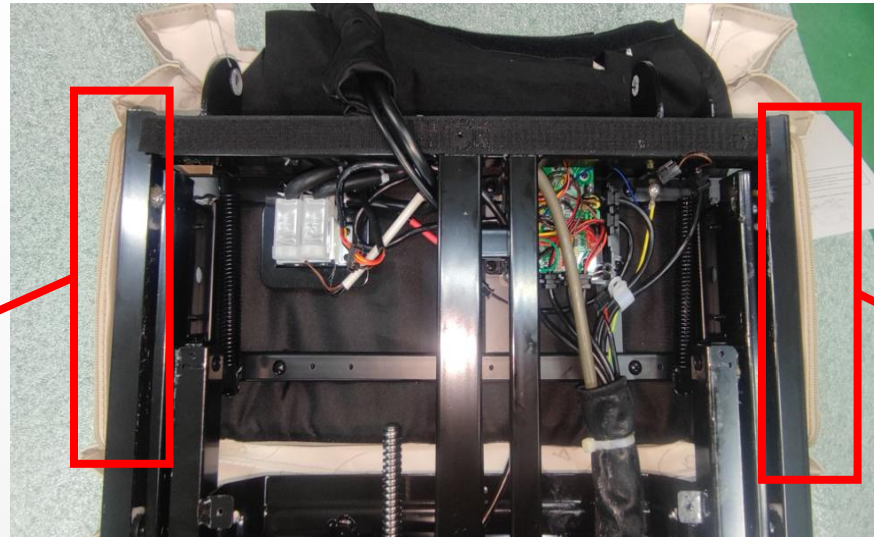
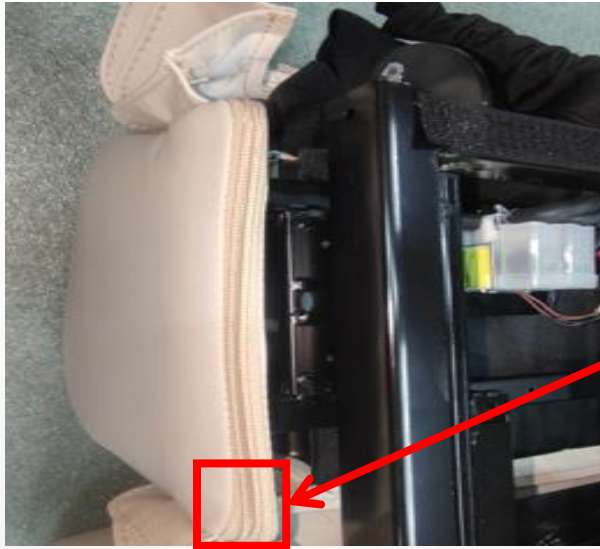

K.unzip the zipper



L. remove 4 screws

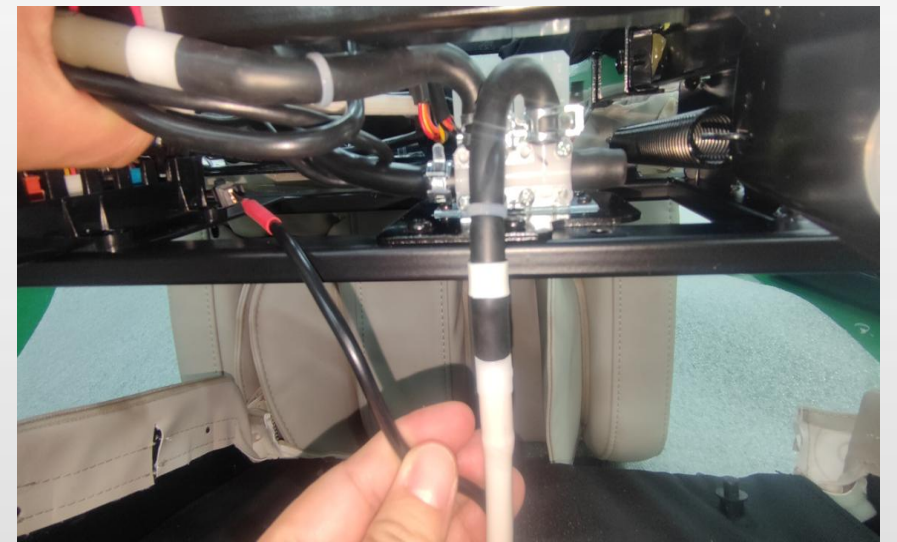

M. Disconnect the terminal and trachea to remove the upper leg

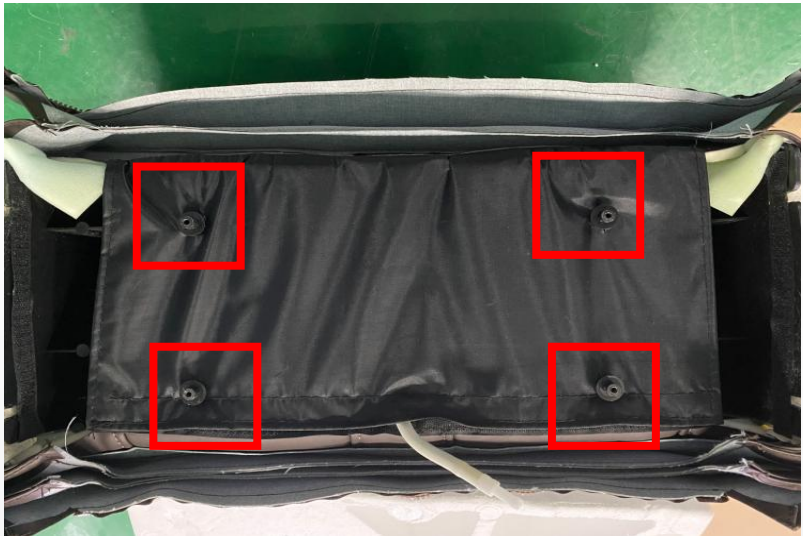

N.remove the fixed 4 support sleeves



O.tear open the adhesive button to remove the upper calf leather cover



upper calf leather cover

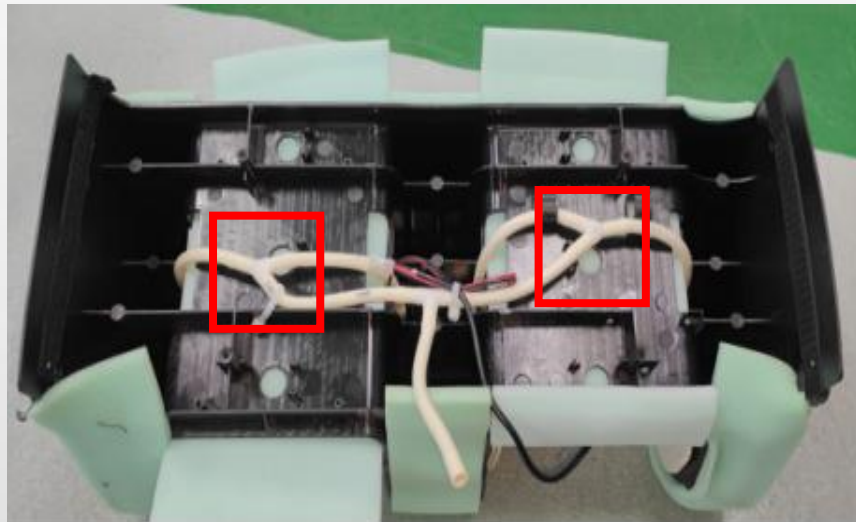

P.pull out the trachea to remove the airbag



upper and lower leg left and right airbags

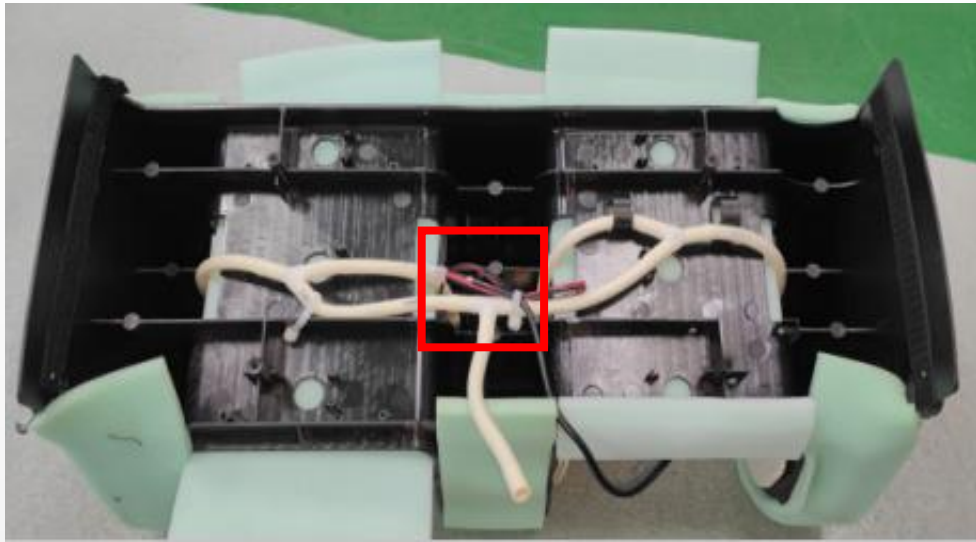

Q.cut off the buckle, remove the wire cap, and then remove the heating wire



heating wire

17、decomposition of the lower legrest:

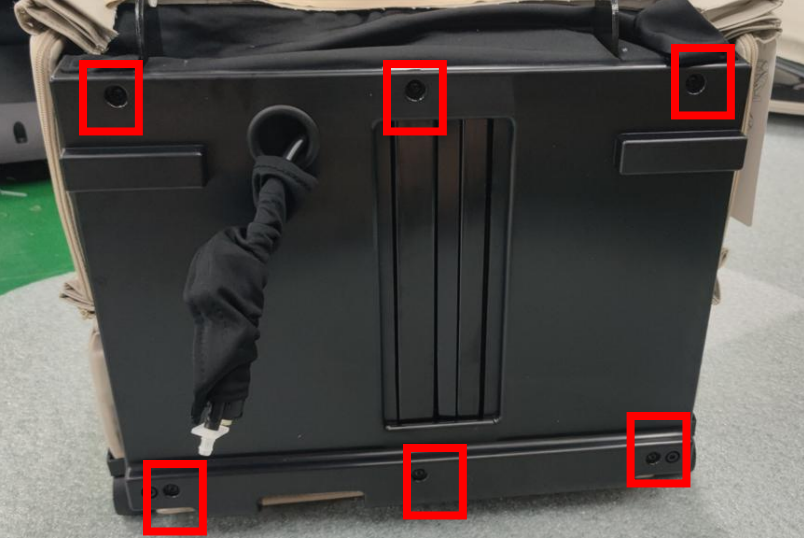

A.remove 6 screws



B.discontent the terminals

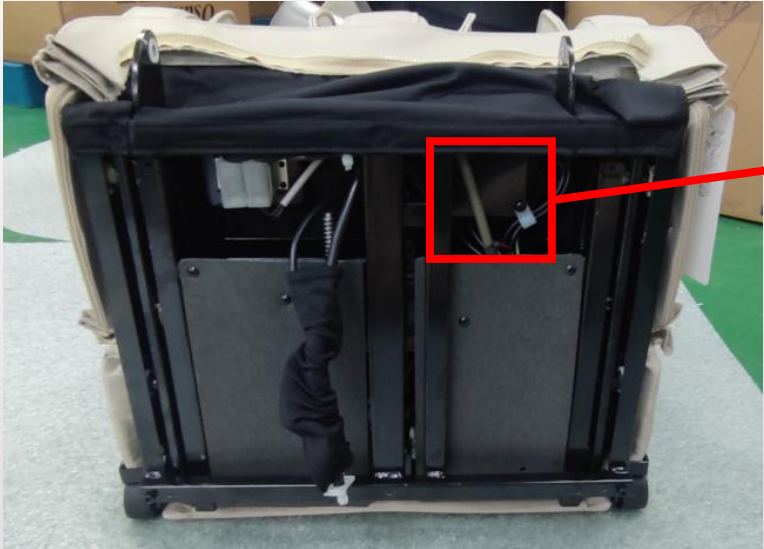

C. remove 4 screws

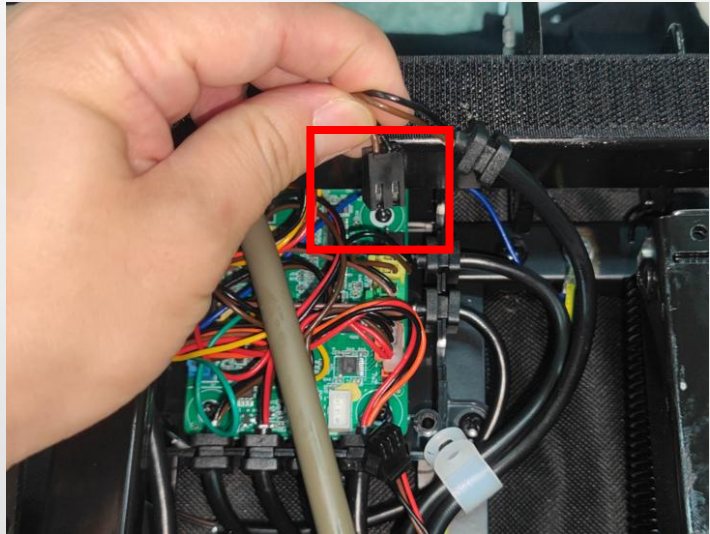
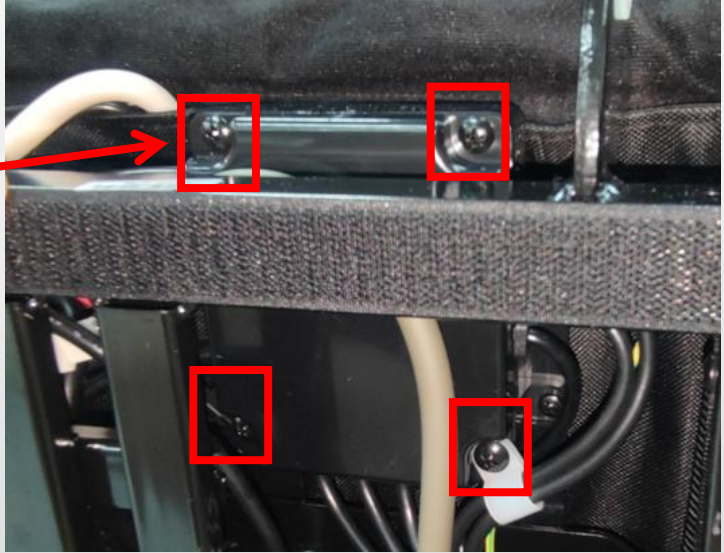

D.use 24V to extend the lower leg



E.unzip the zipper

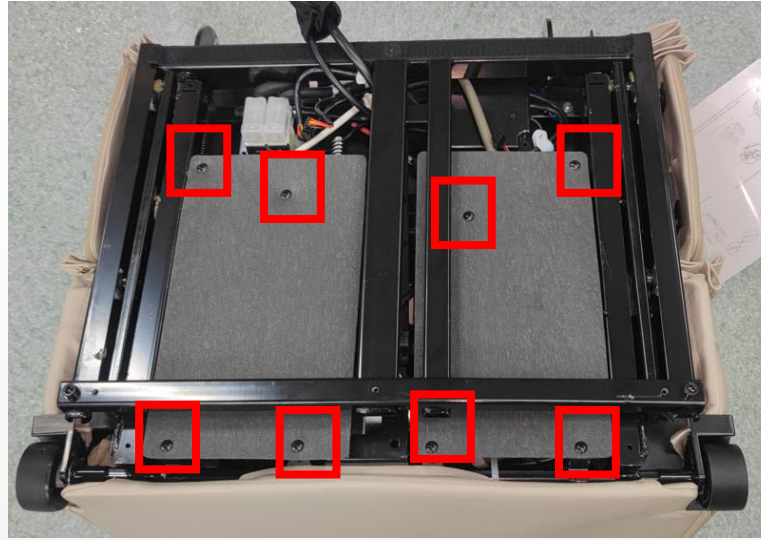

F. remove 8 screws

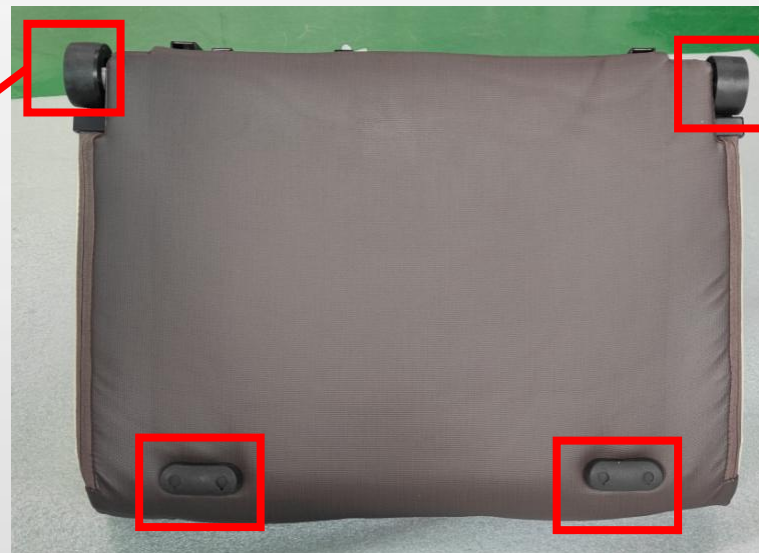

G. remove the covers on both sides of the casters and remove the 4 fixed screws

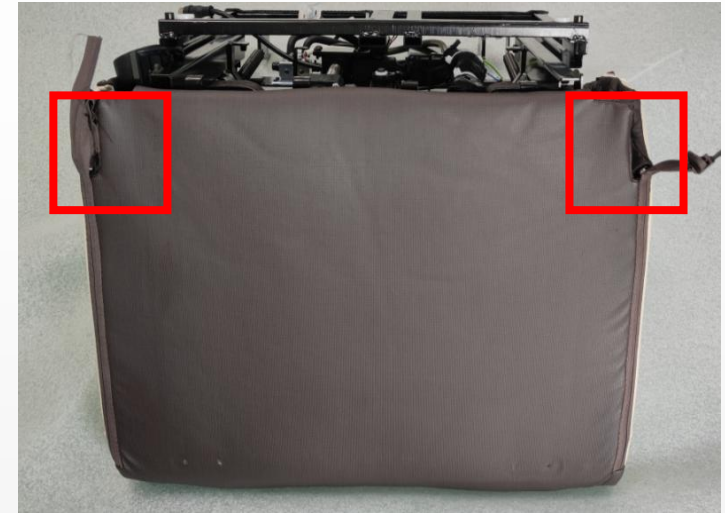

H. remove 2 fixed screws, 1 screw on each side

I. unzip the zipper

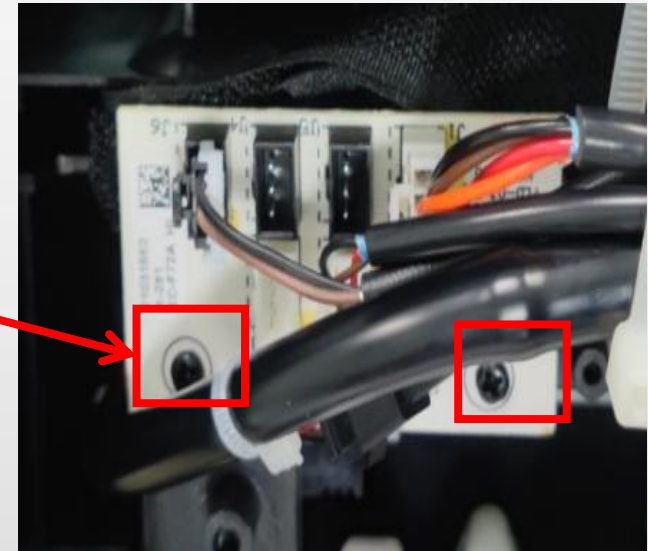
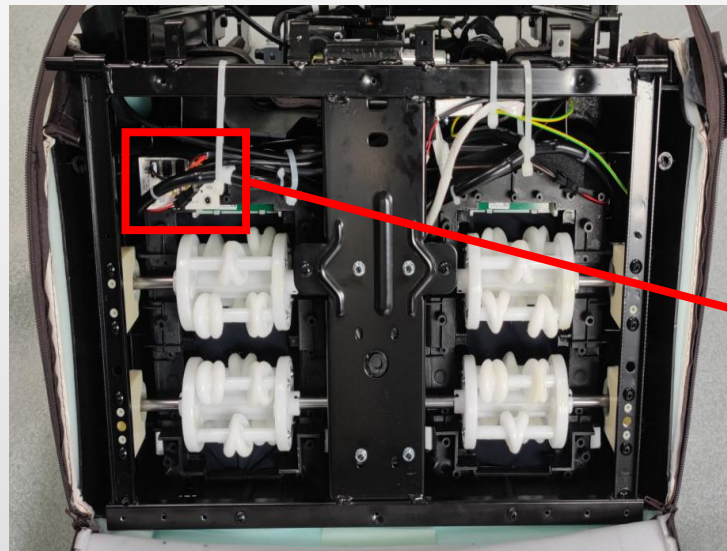
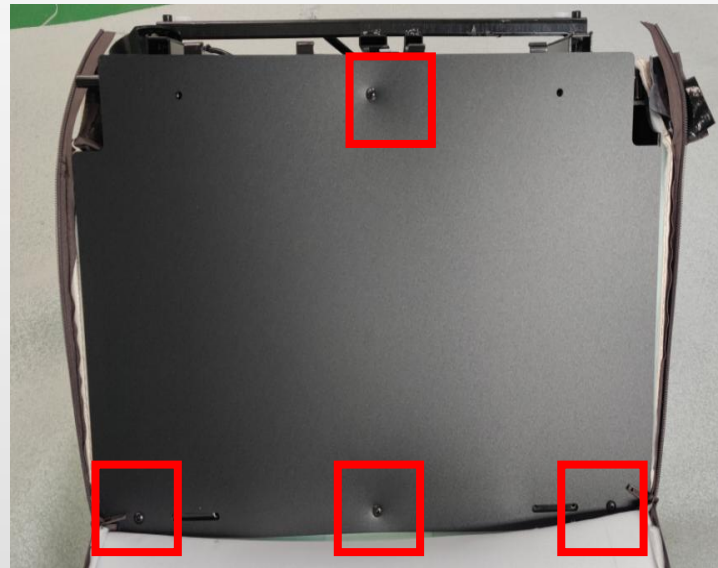

J. remove 4 screws

K. unplug all terminals and remove the 2 fixing screws to remove the anti pinch adapter board

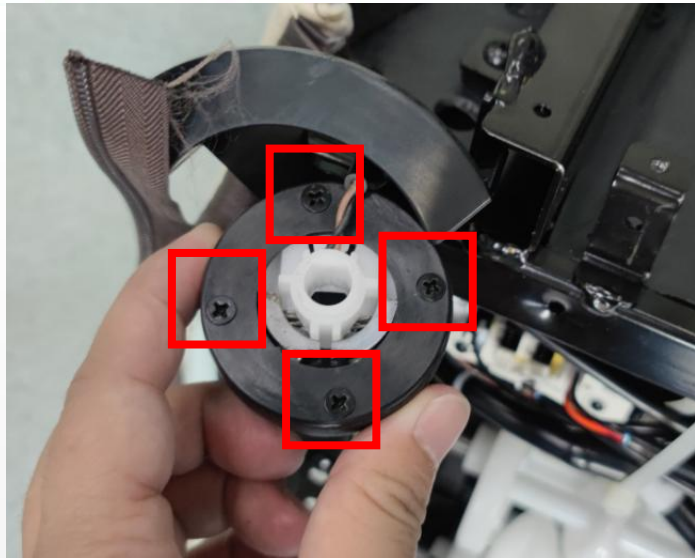

L. remove 4 screws

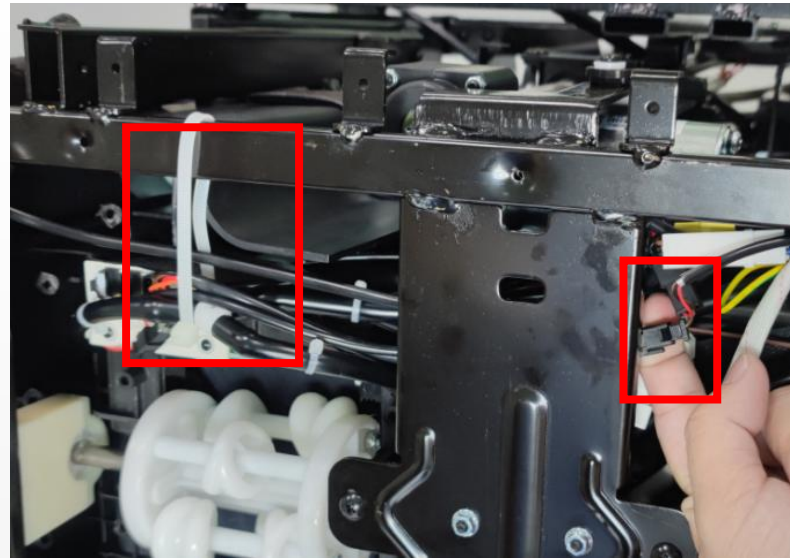

M. cut off the buckle and disconnect the terminal to replace it

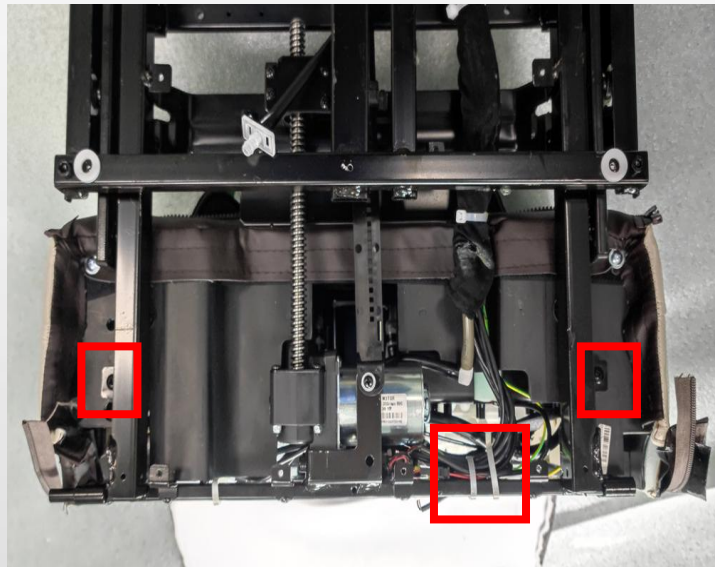

N. remove 2 screws, cut off the buckle
7516E massage chair service guide

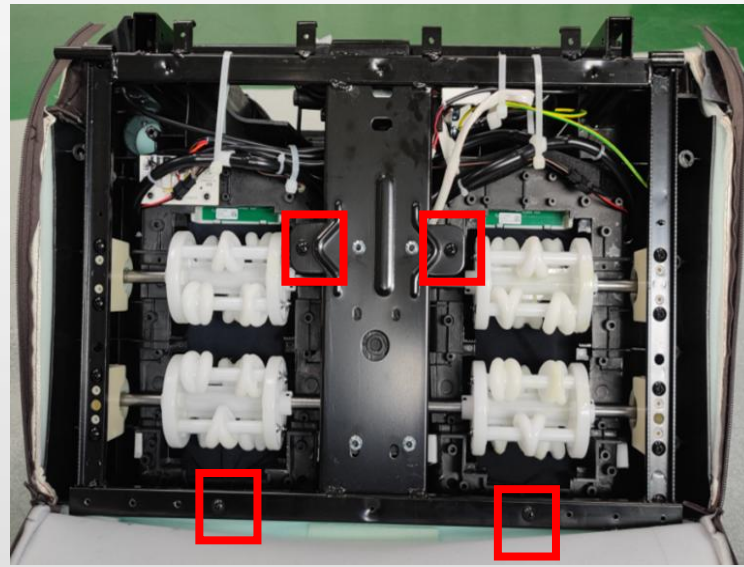

O. remove 4 screws

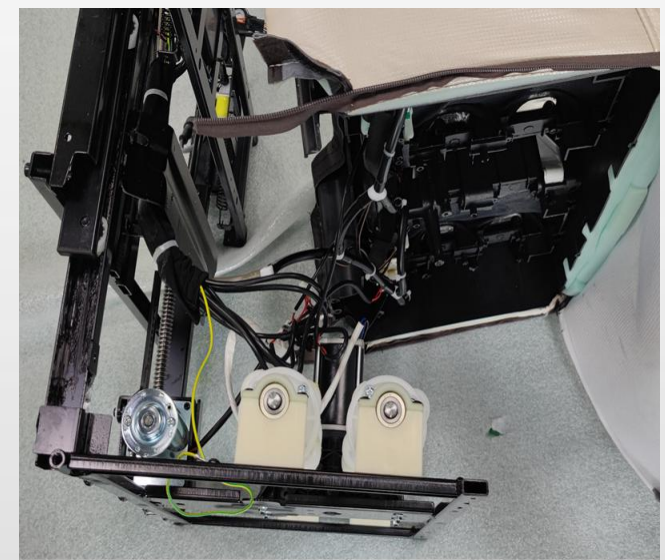

P. disconnect the connecting wire and trachea



Q. remove 4 screws ,tear open the sticky button



Lower calf leather cover

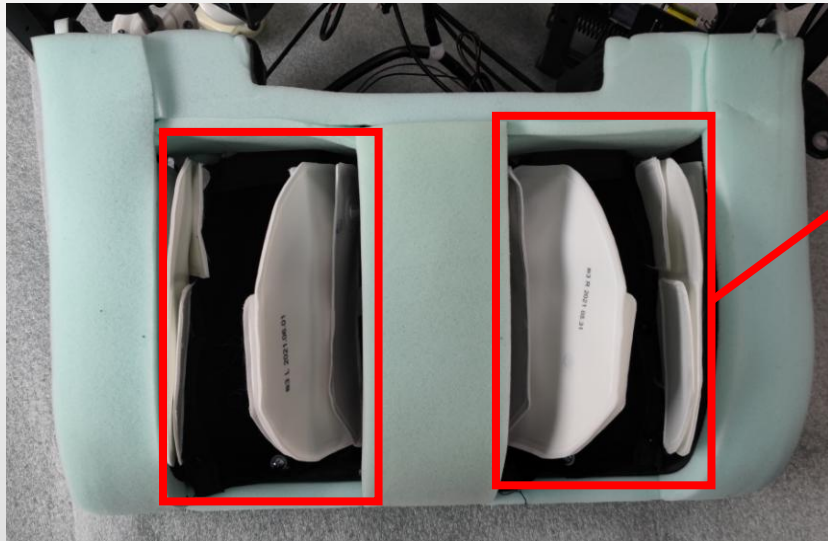

7516E massage chair service guide R. remove 7 screws

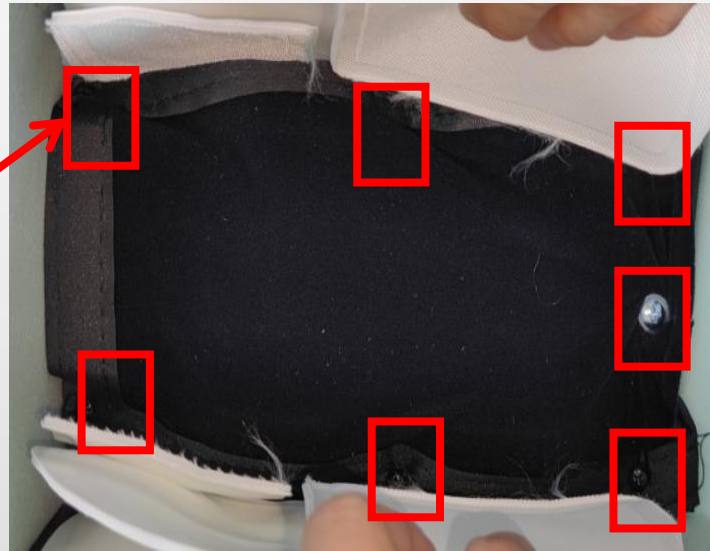

Wear resistant fabric

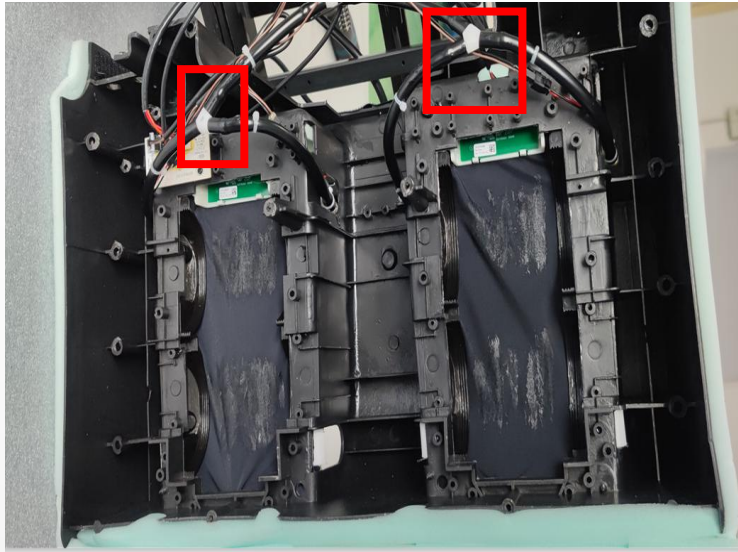

S. remove the trachea

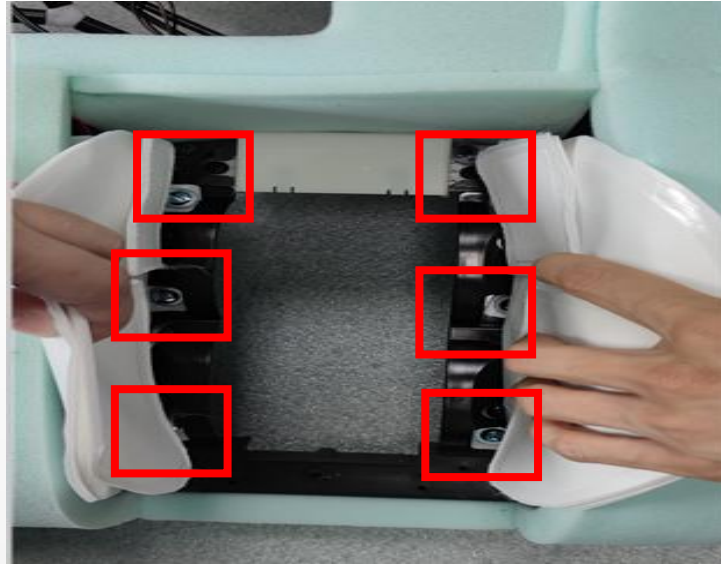

T. remove 6 screws



Lower calf left and right airbags

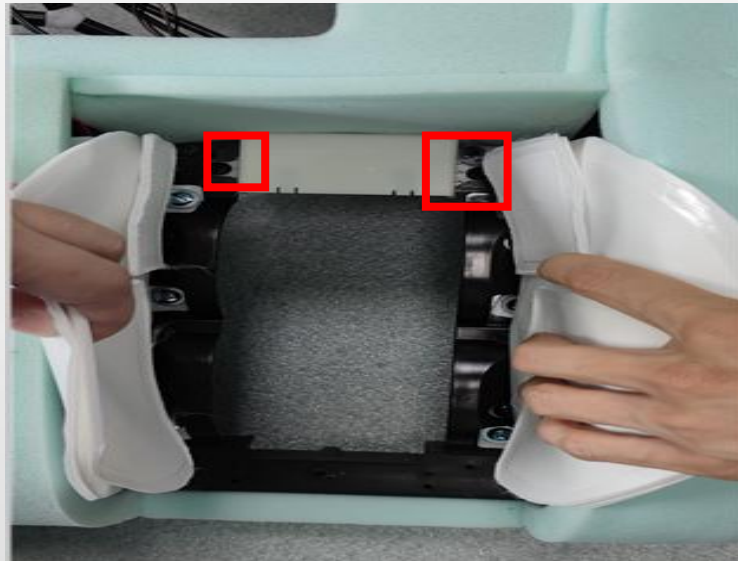

U. remove 2 screws
7516E massage chair service guide

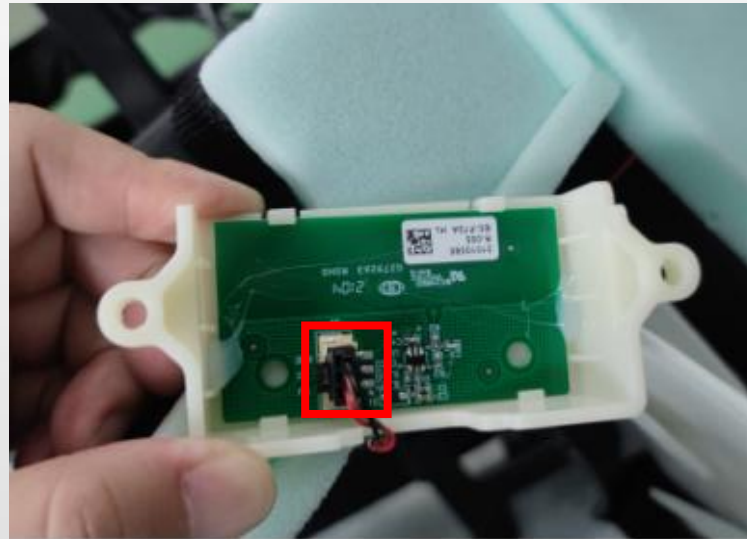

V. Disconnect the connecting wire to replace the leg length detection board



Leg length detection PCB

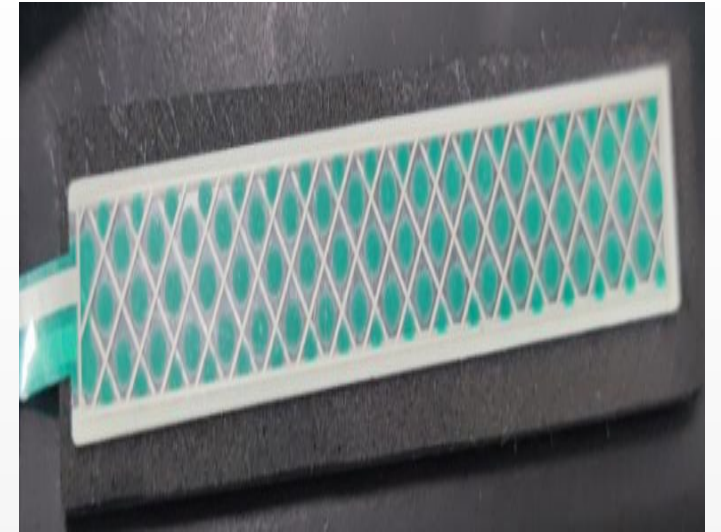
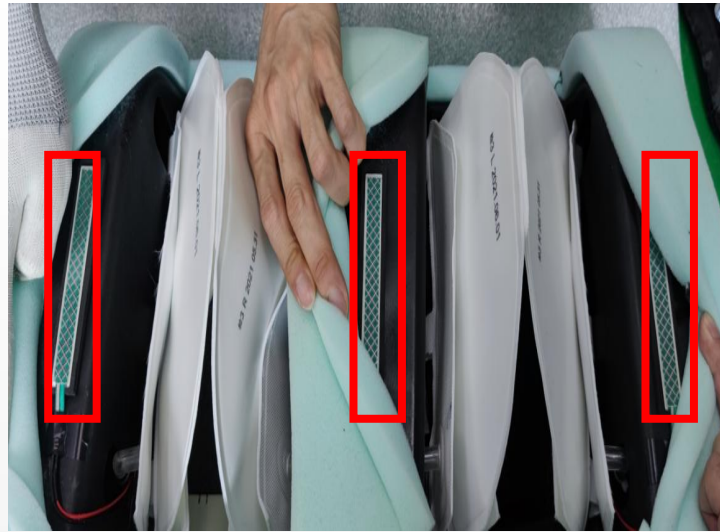
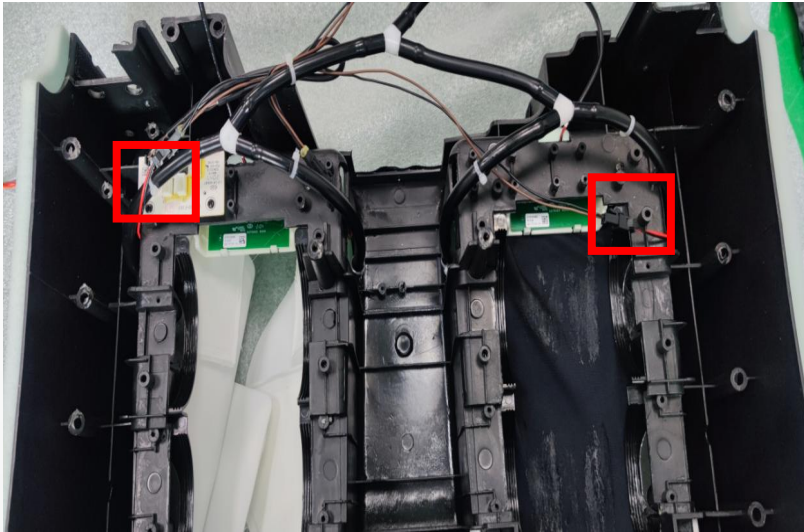

W. disconnect the connecting wire, tear off the adhesive, and replace the film switch

membrane

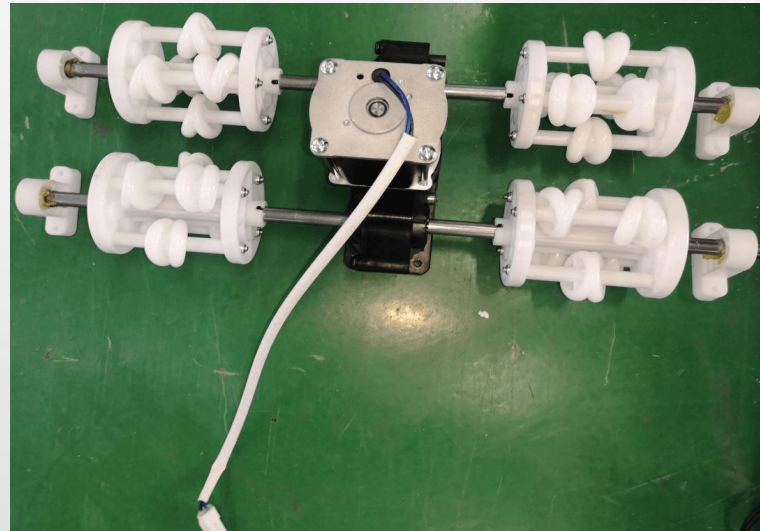
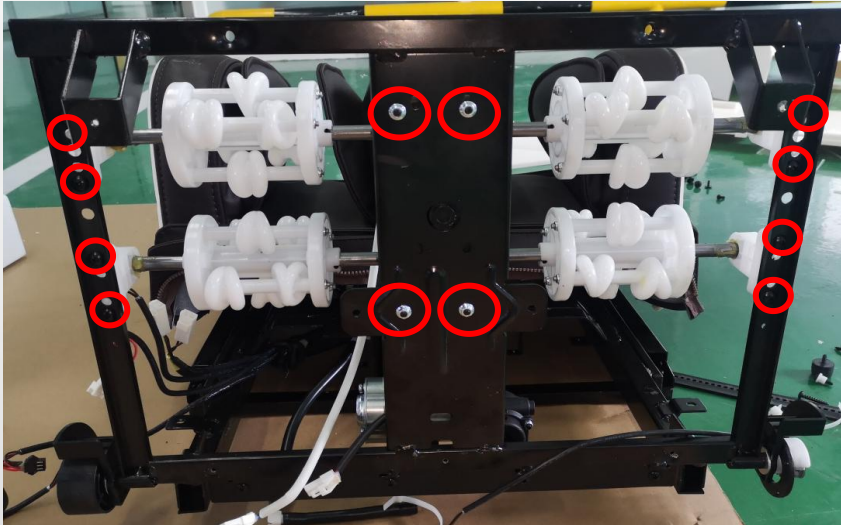

X. remove 12 screws

foot rolling component

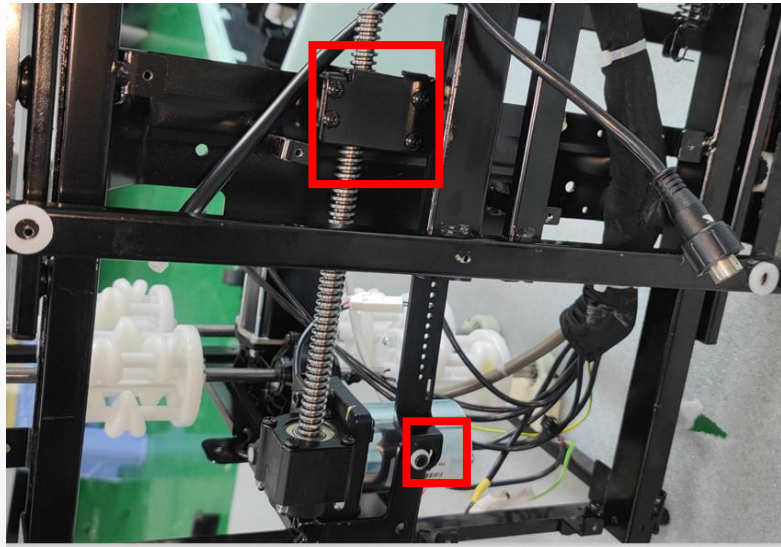

Y. remove 5 screws

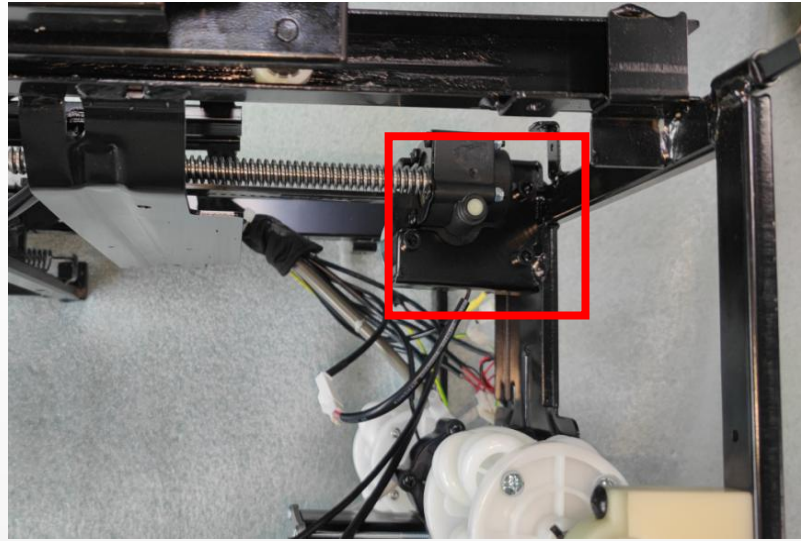

Z. remove 5 screws



calf extension component

18、 disassembly of legrest actuator:



A.remove 4 screws

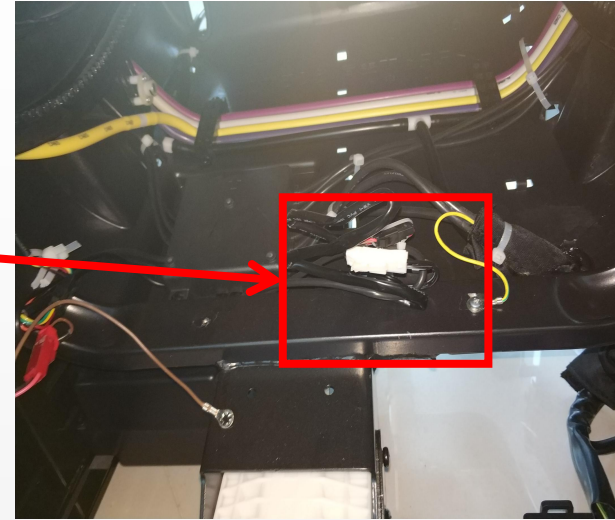
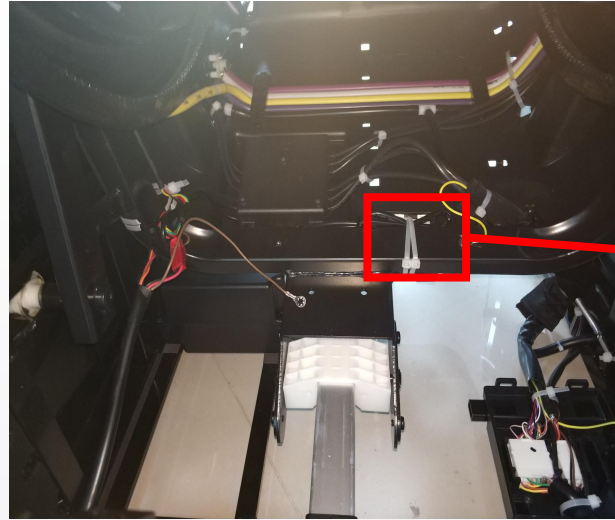

B.cut off the buckle and disconnect the connecting wire

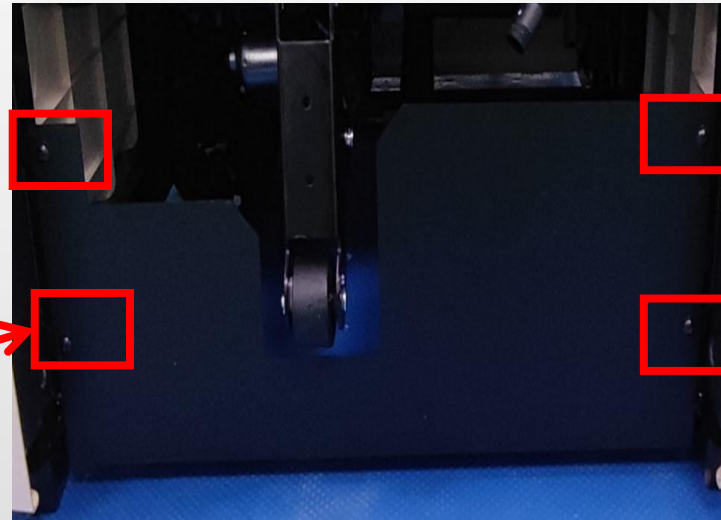
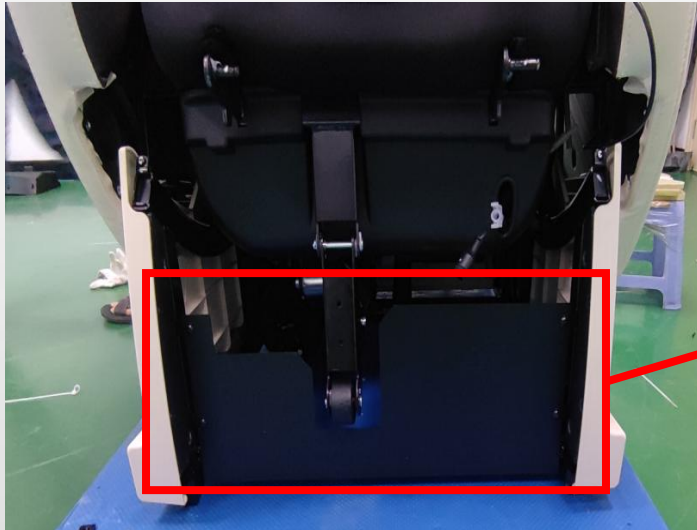

C.remove 4 screws



front Bezel

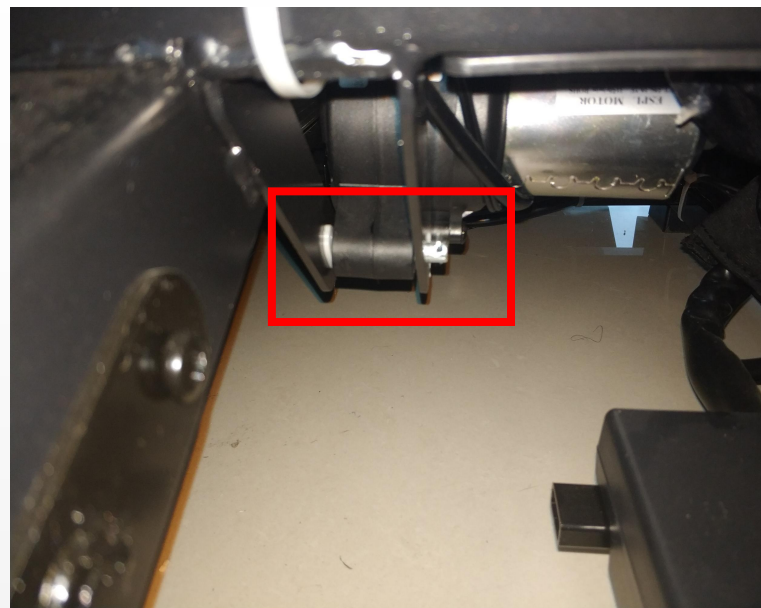
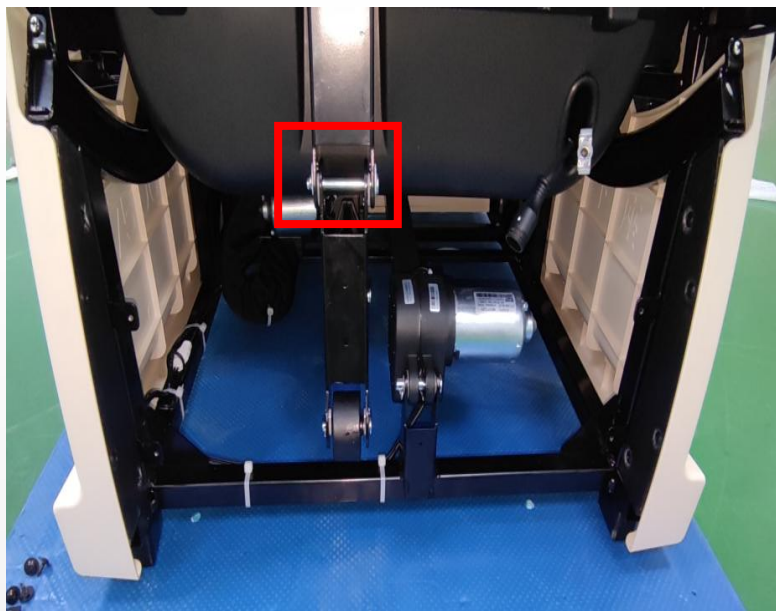

D. Remove the front and rear pins and shafts of the calf push rod to replace it



legrest actuator

19、 disassembly of backrest actuator: (Note that when disassembling the push rod, the lower leg backrest should fall down)

A. Remove the calf assembly (refer to the disassembly of calf assembly)

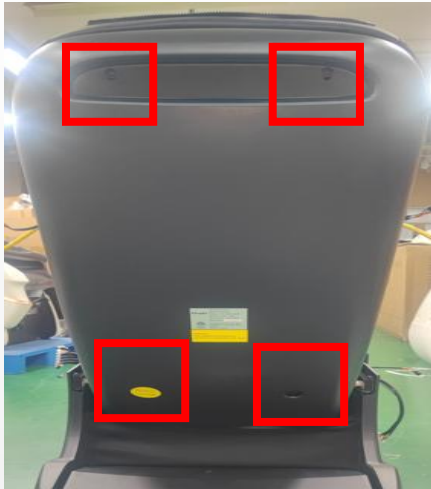

B.remove 4 screws

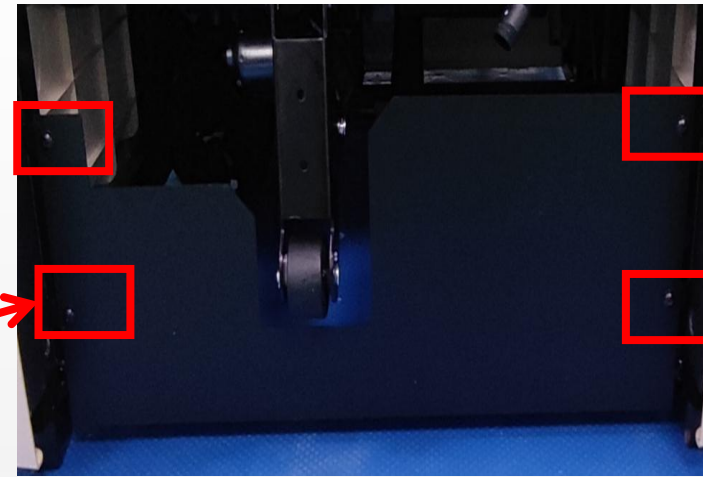
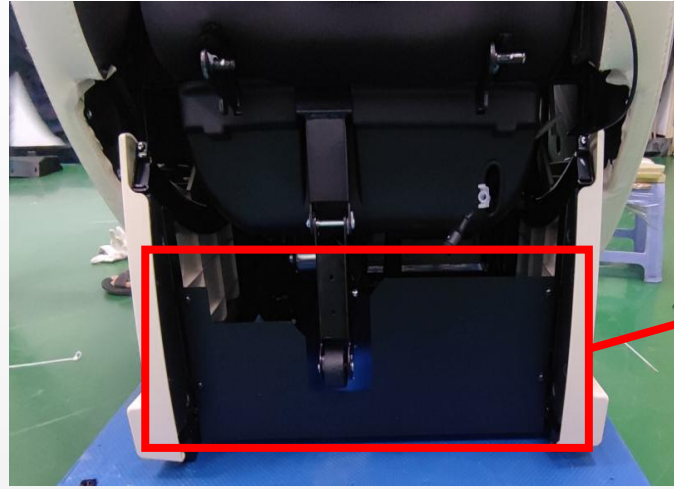

C.remove 4 screws

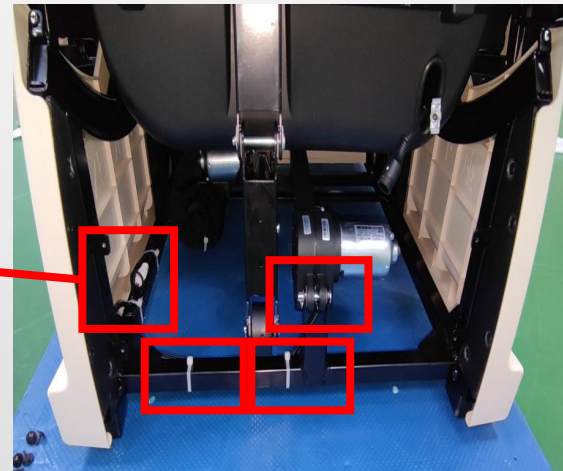
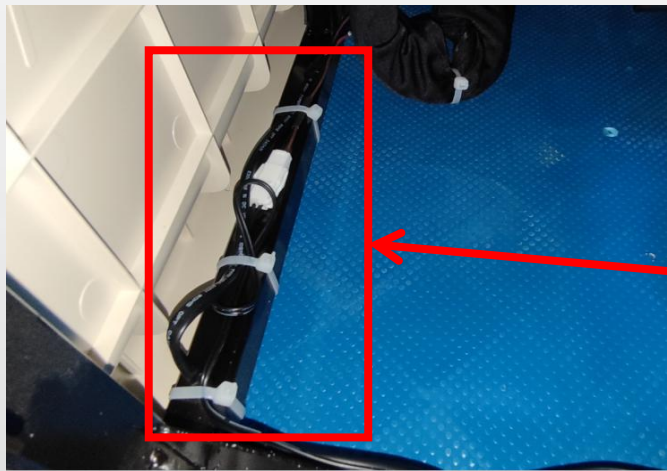

D.Remove the front pin and shaft of the calf push rod, cut off the buckle, and disconnect the connecting wire

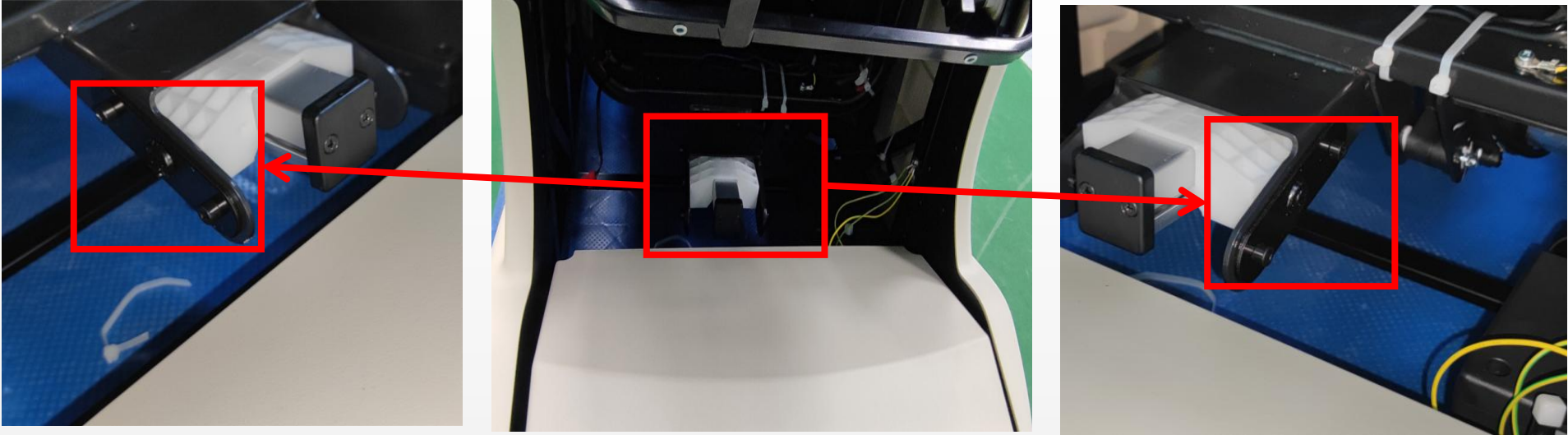

E.remove 2 screws

五、Massage chair fault judgment

1、error code:

Turn on/off: Long press the setting for 4 seconds to enter the password field, enter 0592, and enter the engineering mode interface



No.	phenomenon	problem description	steps of shooting the trouble	remark
1	remote control tested any key pressed more than 45 seconds	1.one of the KEY has been blocked.	1.check the key of the remote control	turn on the chair
2	remote control did not connected	1.remote control wire is broken or the remote control is disconnected	1.reconnecte the remote control or change the remote control wire.	turn on the chair
3	backrest signal is abnormity	1.The connector of the backrest wire is not well connected 2.Backrest wire Broken	1.check the connector of backrest wire 2.change the backrest wire	enter auto-check model
4	rolling signal is abnormity	1.The connector of the backrest wire is not well connected 2.rolling sensor broken	1.check the connector of backrest wire 2.rolling sensor broken	Real time detection when the movement has a walking function enabled
5	Side panel loses communication for more than 4 seconds	1. Disconnected wiring on the side panel	1. Replace the side panel wiring	turn on the chair
6	leg rest tested more than 4 seconds	1.connector of leg rest wire not well 2.wire of leg rest broken	1.check the connector of leg rest wire 2.change the wire of leg rest	enter auto-check model

7	tested more than 2 width inspection signal	1.width inspection board is broken 2.width inspection wire is not well connected	1.change width inspection board 2.change backrest wires.(black)	start the rolling function
8	more than 5 seconds did not tested the wide signal	1.width inspection board is broken 2.the wire connect to the width inspection board is disconnected 3.kneading motor is broken or kneading belt is lost	1.change width inspection board 2.change backrest wires.(black and gray) 3.change kneading motor	enter auto-check model
9	more than 5 seconds did not tested the middle signal	1.width inspection board is broken 2.the wire connect to the width inspection board is disconnected 3.kneading motor is broken or kneading belt is lost	1.change width inspection board 2.change backrest wires.(black and gray) 3.change kneading motor	enter auto-check model
10	more than 5 seconds did not tested the narrow signal	1.width inspection board is broken 2.the wire connect to the width inspection board is disconnected 3.kneading motor is broken or kneading belt is lost	1.change width inspection board 2.change backrest wires.(black and gray) 3.change kneading motor	enter auto-check model

11	more than 10 seconds didn't tested kneading signal	1.Main PCB is broken	1.change PCB	enter auto-check model
12	when not kneading but the width inspection signal still can be tested	1.Main PCB is broken	1.Change PCB	enter auto-check model
13	tested signals from up & down limit sensor at the same time.	1.up & down limit sensor are broken 2.backrest wire(black) is disconnected.	1.Change up & down limit sensor 2.check whether the backrest wire(black)is well connected	enter auto-check model
14	more than 40s didn't tested the signal from the up limit sensor	1.upper limit sensor is broken. 2.backrest wires(black and gray) are disconnected 3.rolling motor is broken or rolling motor wire disconnected	1.change upper limit sensor 2.check whether the backrest wire(black) is well connected. 3.change rolling motor or rolling motor wire.	enter auto-check model
15	height counting signal error	1.the counting sensor of the rolling motor is broken 2.backrest wire(black) is disconnected	1.change the counting sensor of the rolling motor. 2.check whether the backrest wire(black) is well connected.	enter auto-check model

16	after tested signal from up limit sensor then tested signal from down limit sensor in 2 seconds.	1.down limit sensor is broken	1.change down limit sensor 2.check whether the backrest wire(black) is well connected. 3.change rolling motor	enter auto-check model
17	more than 40s didn't tested the signal from the down limit sensor	1.down limit sensor is broken 2.the backrest wire(black) is disconnected. 3.rolling motor is broken or disconnected	1.change down limit sensor 2.check whether the backrest wire(black) is well connected. 3.change rolling motor	enter auto-check model
18	after tested signal from down limit sensor then tested signal from up limit sensor in 2 seconds.	1.upper limit sensor is broken.	1.change upper limit sensor	enter auto-check model
19	can't test signal from foot rest recline actuator	1.foot rest recline actuator is broken 2.foot rest actuator motor wire is disconnected 3.the signal wire of foot rest actuator is disconnected.	1.change foot rest recline actuator 2.check whether the foot rest recline actuator motor wire is well connected. 3.check whether the signal wire of foot rest actuator is well connected	enter auto-check model

20	Both the long and short limits of calf extension and contraction are effective simultaneously	1. Lower leg limit failure	1. Replace the calf limit plate	enter auto-check model
21	No length limit detected after 20 seconds of calf elongation	1. Lower leg limit failure	1. Replace the calf limit plate	enter auto-check model
22	After detecting the long limit, a short limit was detected 2.5 seconds later	1. Lower leg limit failure	1. Replace the calf limit plate	enter auto-check model
23	Shortened calf by 20 seconds, no short limit detected	1. Lower leg limit failure	1. Replace the calf limit plate	enter auto-check model
24	After detecting the short limit, the long limit was detected 2.5 seconds later	1. Lower leg limit failure	1. Replace the calf limit plate	enter auto-check model
25	when start the backrest recline actuator, there is no counting signal for more than 2.5 seconds	1.backrest recline actuator is broken 2.backrest recline actuator wire is disconnected 3.the signal wire of the backrest recline wire is disconnected	1.change backrest recline actuator 2.check whether backrest recline actuator motor wire is well connected. 3.check whether the signal wire of the backrest recline actuator is well connected	enter auto-check model

27	tested signals from front&back limit sensor at the same time (3D)	1.3D limit sensor broken 2.3D limit sensor wire broken	1.change 3D limit sensor 2.cheke whether 3D limit sensor wire connect well or not	enter auto-check model
28	3D limit sensor tester more than 10 seconds(3D)	1.3D limit sensor broken 2.3D limit sensor wire broken 3.3D motor broken 4.The 3D light shield is loose	1.change 3D limit sensor 2.cheke whether 3D limit sensor wire connect well or not 3.change 3D motor 4.check wether the 3D light shield is loose	enter auto-check model
29	3D counting signal is abnormity	1.3D counting sensor is broken 2.3D counting sensor wire connect not well	1.change 3D counting sensor 2.check wether 3D counting sensor wire connect well	enter auto-check model
30	After tested 3D limit sensor signal, then tested the other limit sensor signal in 2 seconds	1.3D limit sensor brken	1.change 3D limit sensor	enter auto-check model
31	Side panel button or POWER button stuck for more than 50 seconds	1.one of the KEY has been blocked.	1.check the key of the side panel	turn on the chair



7516E故障代码.xls