



**EASEPAL**

厦门蒙发利电子有限公司客户服务部

# EC-3210G massage chair service guide





## Table of Contents

**一、Product introduction**

**二、Massage chair tools and use**

**三、Working principle of product circuit**

**四、Internal structure and disassembly of massage chair**



**EASEPAL**

厦门蒙发利电子有限公司客户服务部

## 一、Product introduction

### 1、Product appearance size:





**EASEPAL**

厦门蒙发利电子有限公司客户服务部

## 2、specifications of the products :

Description	Specifications
Model No.	Osaki OS-Champ
Rated Voltage	110-120V~
Rated Frequency	60Hz
Rated Power Consumption	120W
Timer	5/10/15/20/25/30 minutes
Rated Time	15 minutes
Dimensions(L x W x H)	Upright: 55.1" x 33.1" x 44.3"
	Reclined: 67.3" x 30.1" x 33.9"
Weight	Gross Weight: Approx. 220 lbs
	Net Weight: Approx. 189 lbs
Length of Wire	Controller wire: 59.0"
	Power supply wire: 70.9"
Usage Condition	Environment temperature: 32°F~95°F
	Contrasting humidity: 20-80RH
Storage Condition	Storage temperature: 32°F~95°F
	Storage humidity: 20-80RH
Safety Feature	Equipped with overheated and power
Maximum body weight of user	220 lbs



EASEPAL

厦门蒙发利电子有限公司客户服务部

### 3、Appearance of the whole machine:

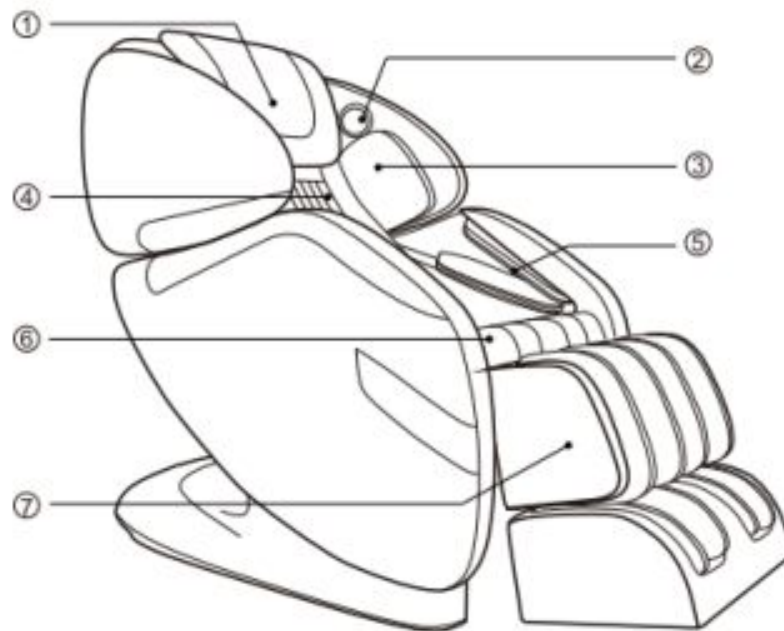

- |                                 |                     |
|---------------------------------|---------------------|
| ① Pillow Pad                    | ② Bluetooth Speaker |
| ③ Shoulder side massage section | ④ Backrest Pad      |
| ⑤ Hand and arm massage section  | ⑥ Seat              |
| ⑦ Legrest                       |                     |



EASEPAL

厦门蒙发利电子有限公司客户服务部

### Air Massage Area

### 3、Appearance of the whole machine:

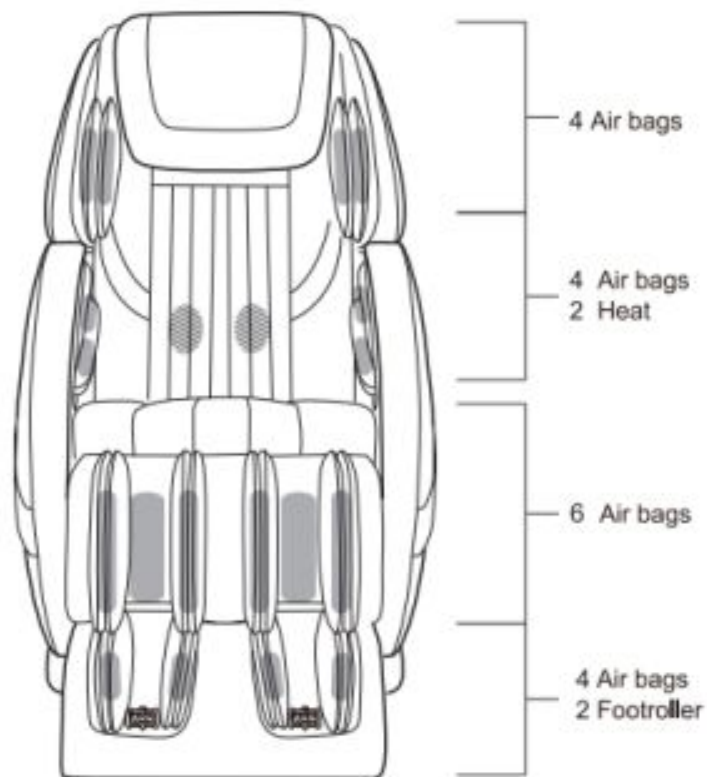

 Air bag     Heat     Foot Roller



## 二、Massage chair tools and use

### 1.tools

					
Screwdriver size 1,2,3	Diagonal cutter and long nose pliers	Soldering Kit	Spanner tools Kit	Test pen	Allen Key set
					
Ratchet Tools Set	24V/DC power	Electric Driver	electrical adhesive tape	Cable Ties	WIRE ONECTORS



## 二、Massage chair tools and use

### 2、Use and measurement of digital multimeter

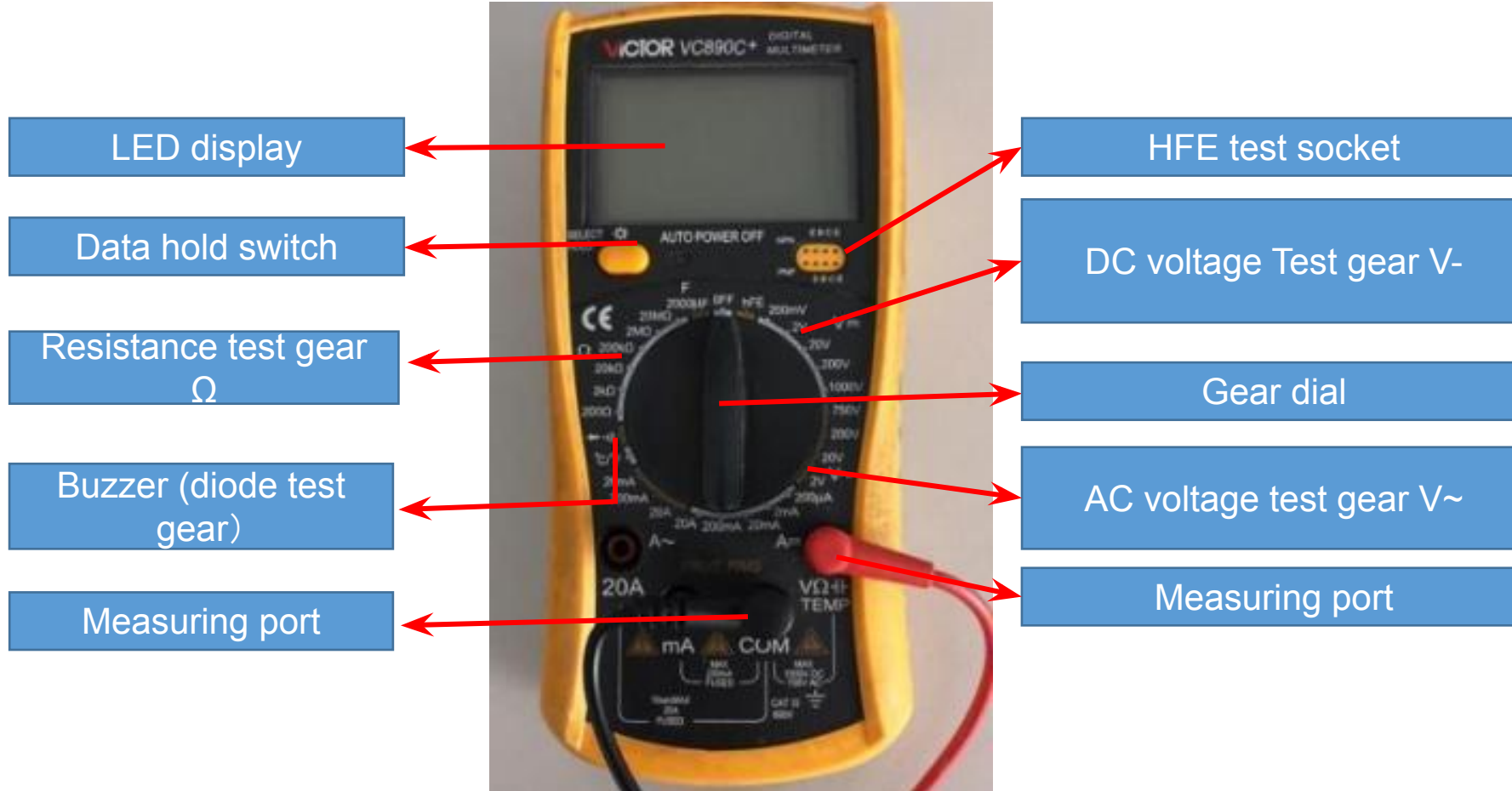



## 2.1、Function of the test gears

**Data hold switch**: Memorize the measured data for comparison。

**Buzzer (diode test gear)**: Measure the quality of diode, the on-off and alarm function of circuit

**Resistance gear test gear**: Measure the quality and value of resistance

**DC voltage Test gear V-**: Measure DC voltage

**AC voltage test gear V~**: Measure AC voltage

**VΩ / COM**: VΩ Red pen port (+ pole) during test, black pen port (- pole) during com test

**Note**: when carrying out resistance or voltage test, it is necessary to select a suitable range. If the range is too small to be measured, and the range is too large, the test error range is large; if the voltage is not known, it is necessary to select a range measurement with a large windlass.

## 2.2、On / off measurement of lines



**open circuit**

As shown in the left picture, first set the multimeter to the buzzer and power it  
When the switch is on, the multimeter will display "0."; then contact the two probes with the ends of the red wire  
At this time, the multimeter still shows "1." there is no change, which means there is an open circuit in the middle of the wire, that is, the line is open.



**close circuit**

As shown in the picture on the left, if the multimeter shows the number of ". 002" or ". 00n" and gives an alarm, it means that the wire is connected.

### 2.3、Measurement of AC voltage



As shown in the picture above: measure the household plug-in board power supply (220V), select the range of 750, and the test result shows "224", indicating that the actual voltage of this group of sockets is 224v at the moment (the switch is pressed down, so there is power, and the light is on).



As shown in the above picture: measure the power supply (220V) of our household plug-in board, select the range of 750, and the test result is displayed as "001", indicating that the actual voltage of this group of sockets is 0V at the moment (the switch is not pressed down, so there is no power, and the light is not on).

## 2.4、DC voltage measurement



As shown in the picture above: the test result is "1.58", indicating that the voltage at both ends of the battery is 1.58v, and the red lead is connected to the "+" pole of the battery, and the black lead is connected to the "-" pole of the electromagnetic.



As shown in the above picture: the test result is "- 1.58", indicating that the voltage at both ends of the battery is 1.58v, and the red lead is connected to the "-" pole of the battery, and the black lead is connected to the "+" pole of the electromagnetic



### 三、Working principle of product circuit

#### 1、main PCB:

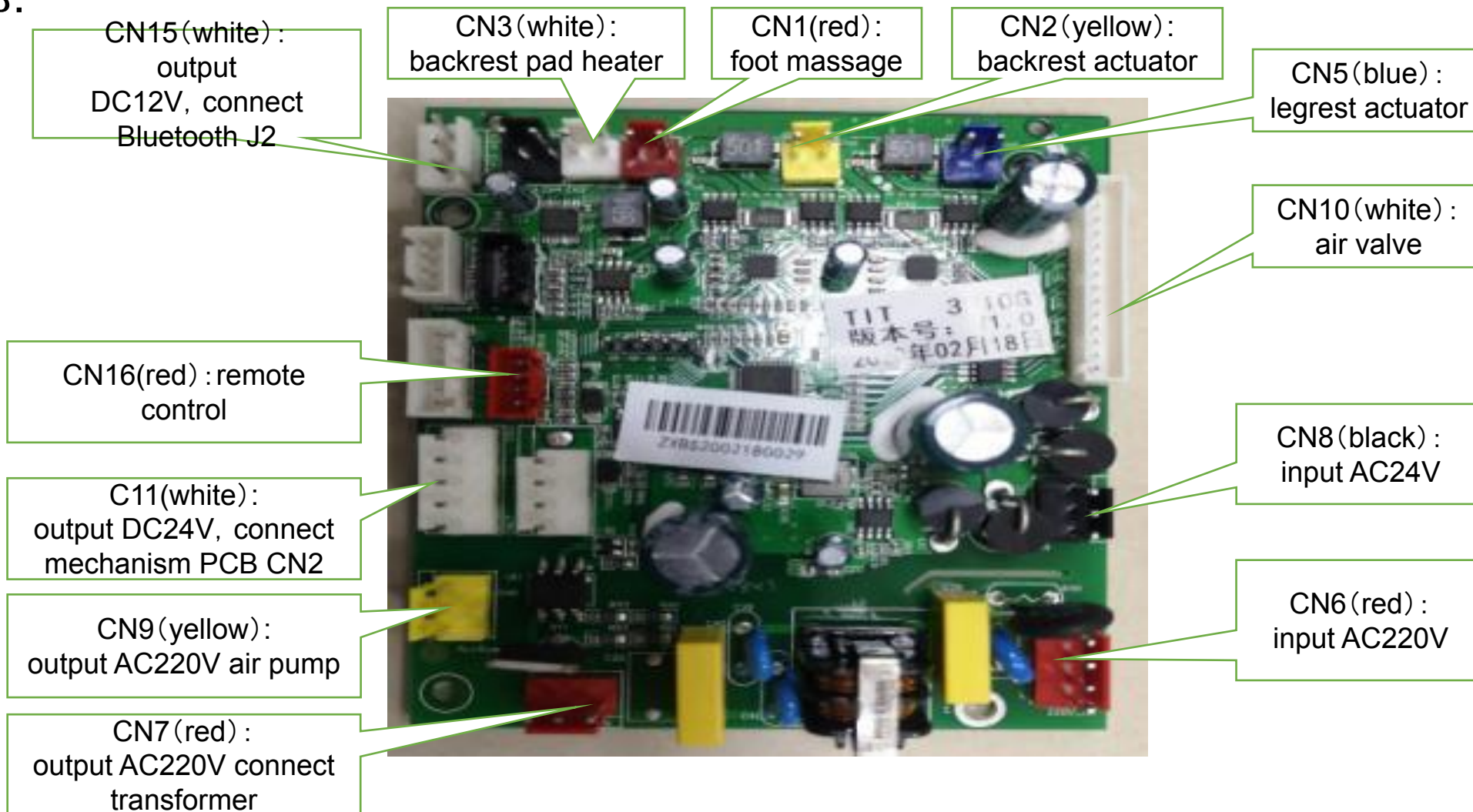



## 2、mechanism PCB:

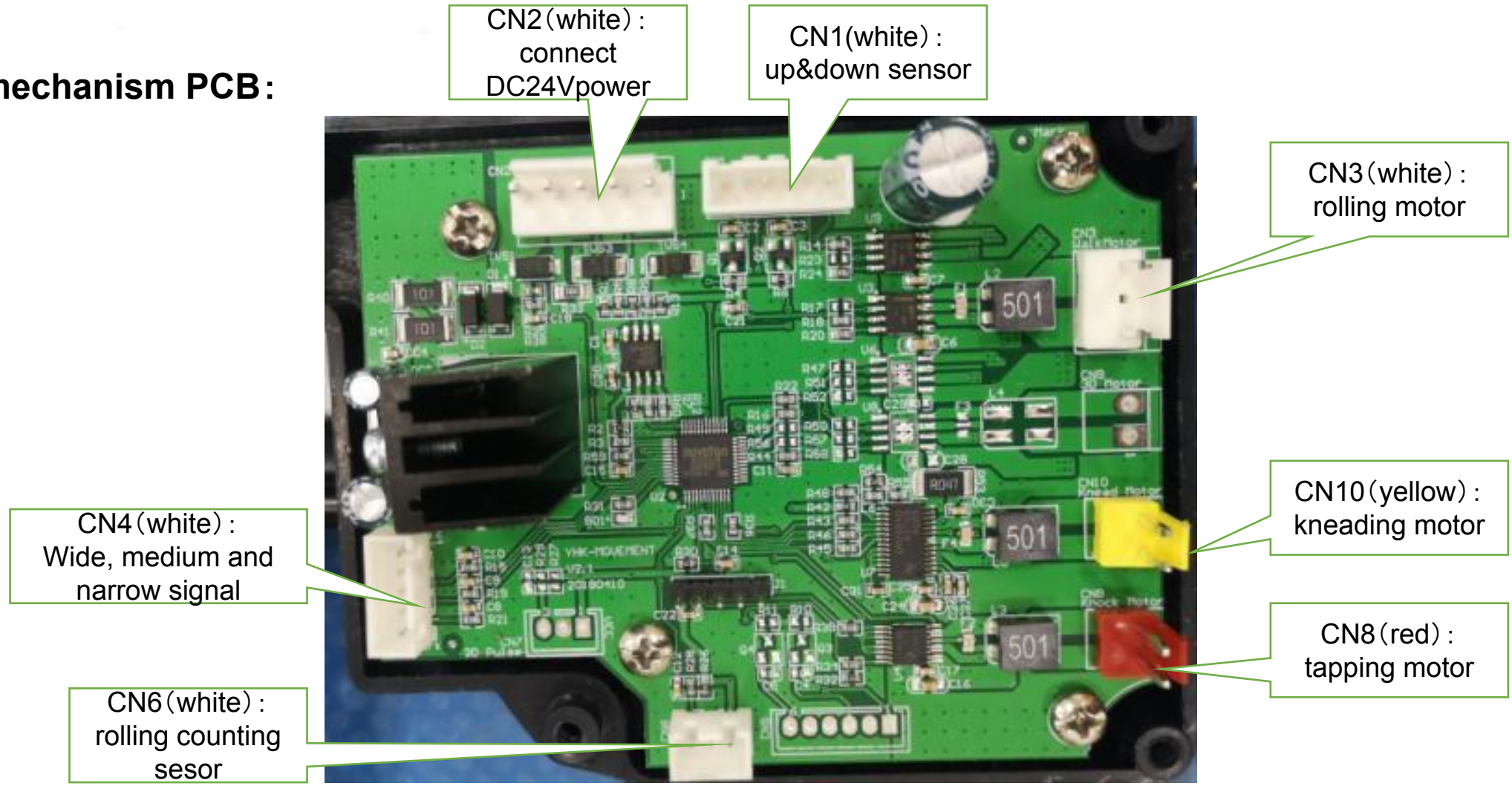



#### 4、Bluetooth:

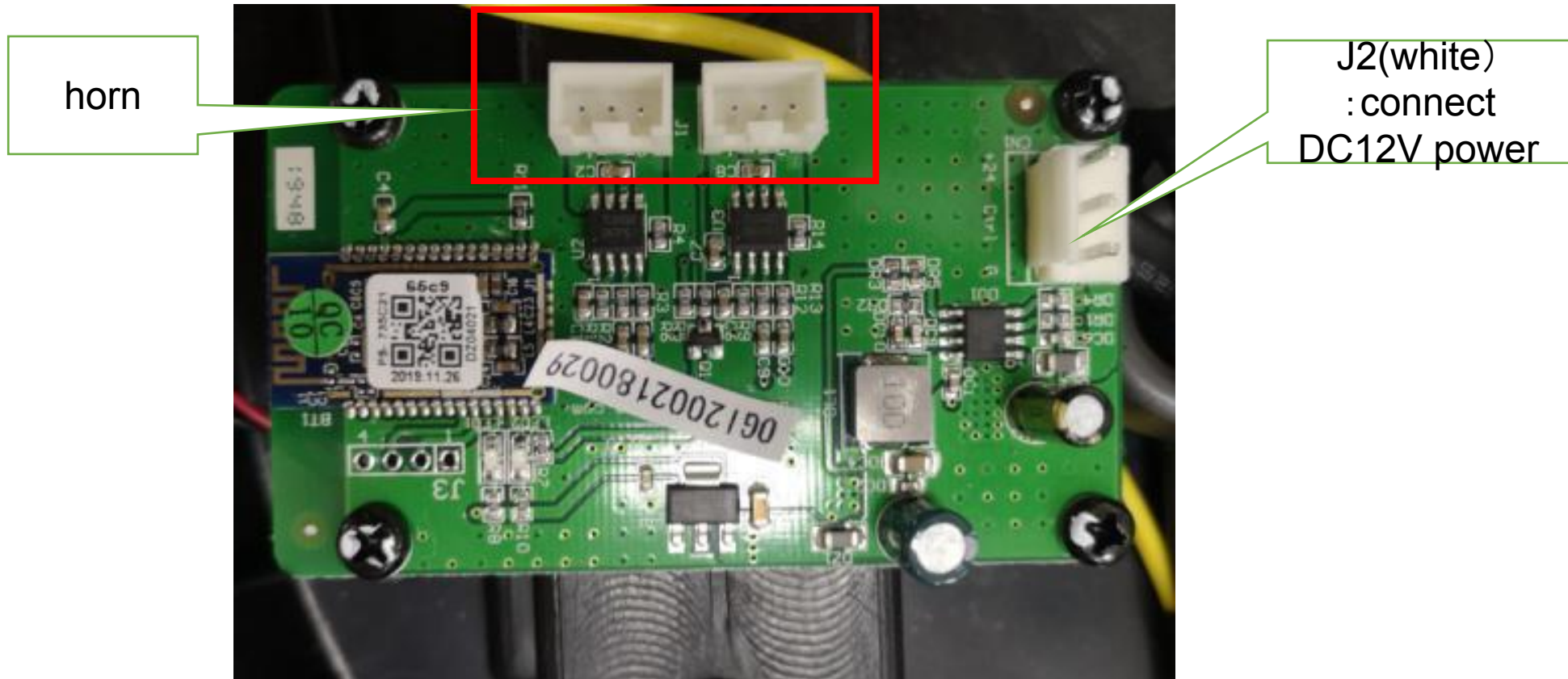



## 四、Internal structure and disassembly of massage chair

### 1.1、Internal structure diagram (overall):

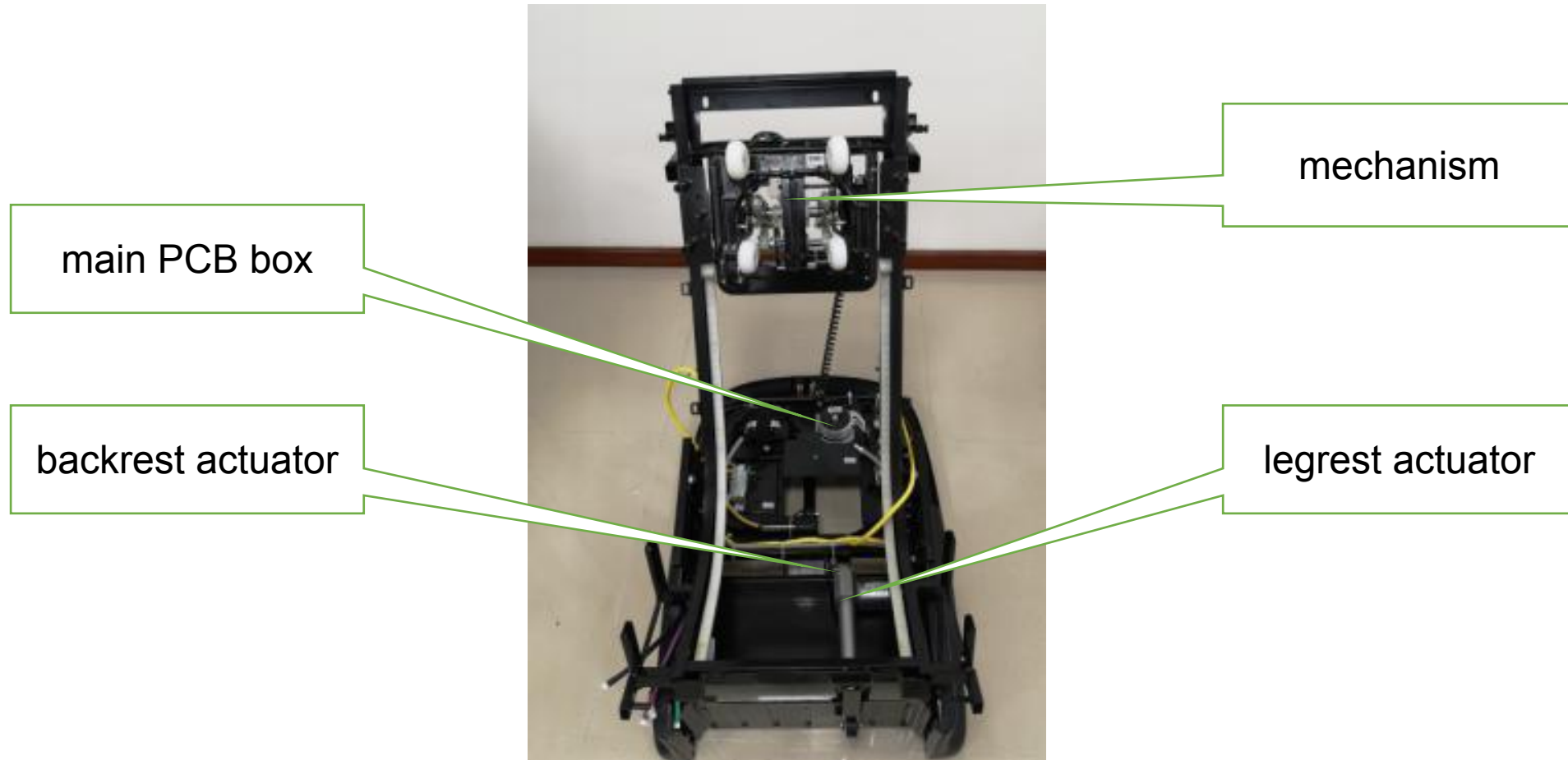

## 1.2、 Internal structure diagram of main PCB box (main PCB box):





## 2、structure diagram of legrest:



Iron frame of legrest



foot massage



leg rest



upper legrest



lower legrest



### 3.1、disassembly of the pillow:



unzip the zipper, take down the pillow



the pillow



### 3.2、disassembly of the backrest pad:



unzip the zipper



unzip the zipper



Tear off the velcro



unzip the zipper both side



Unplug the heating terminal



backrest pad

### 3.3、disassembly of the side panel:



unzip the zipper both side



remove 2 screws both side



remove the screws and unzip the zipper

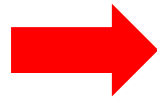

cut the cable tie, disconnect the horn terminal and air hose



Lift up the side plate according to the sequence 1 and 2 (the sequence marked above), and then remove the side panel

**3.4、disassembly of the shoulder massage unit:**



unzip the zipper

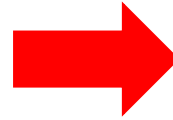

remove 2 screws



unzip the zipper

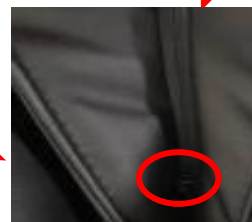

disconnect the air hose and take down the shoulder massage



### 3.5、disassembly of the legrest



remove 2 screws

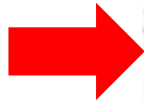

take down the pin



move the legrest towards the left



move the legrest towards the right

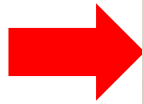

disconnect the air hose and terminals, take down legrest

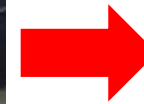

legrest unit

### 3.6、disassembly of the front backrest cover

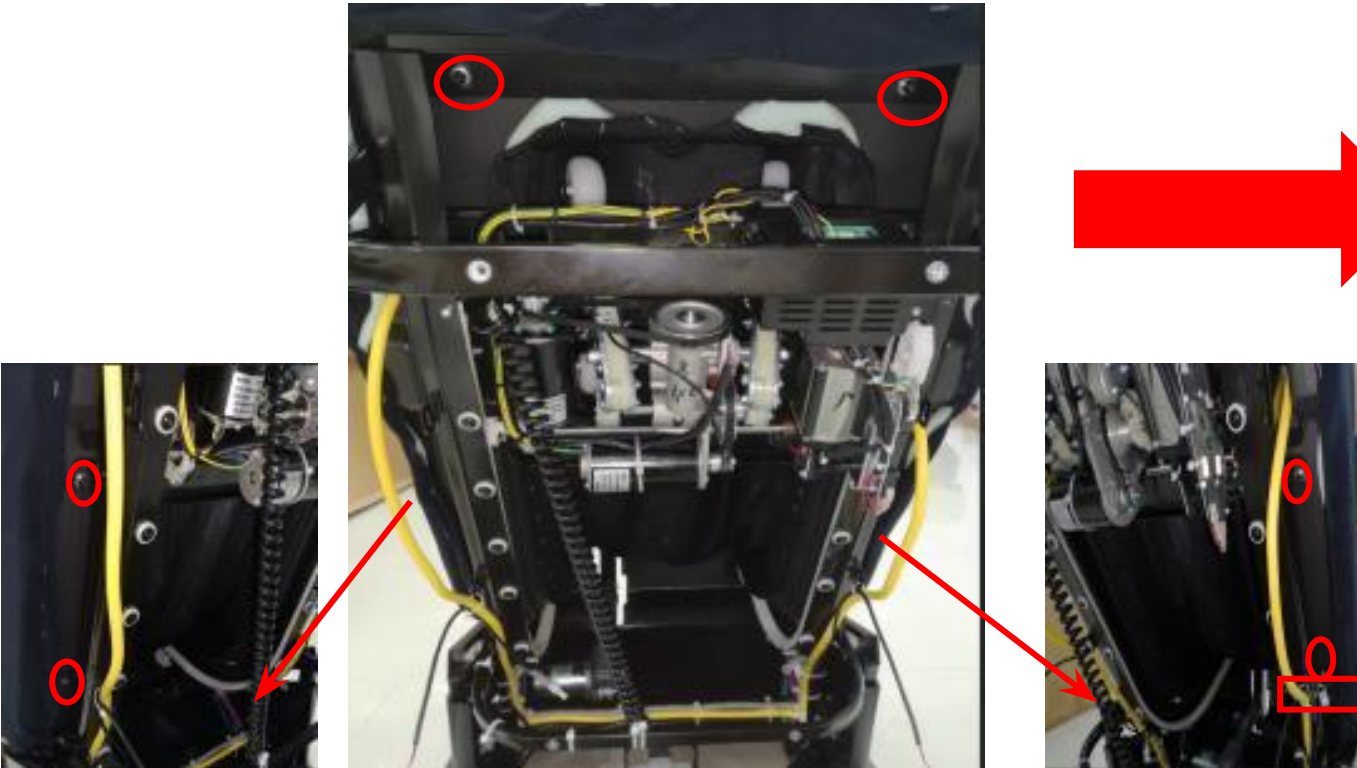

remove 6 screws , Remove the r-clamp



remove 2 screws, now we can take down the front backrest cover

### 3.7 disassembly of the mechanism: (refer to disassembly of the front backrest cover)



remove 4 screws, take down the frame

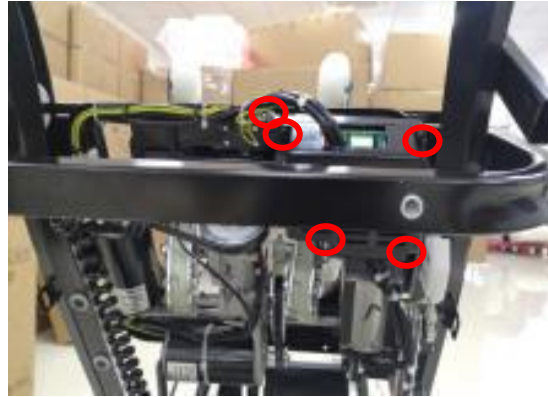

take down the screw fixing the ground wire and 4 screws fixing the box

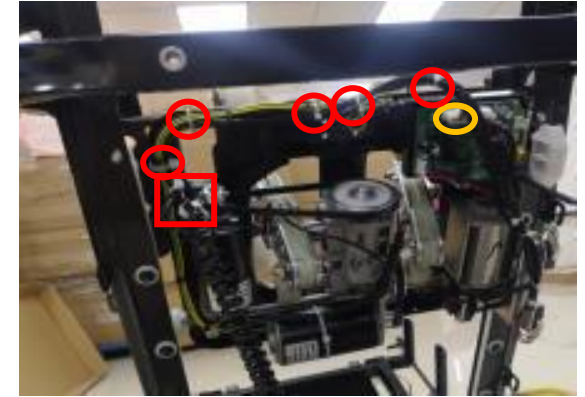

cut the cable tie (red mark), disconnect the white terminal (yellow mark)

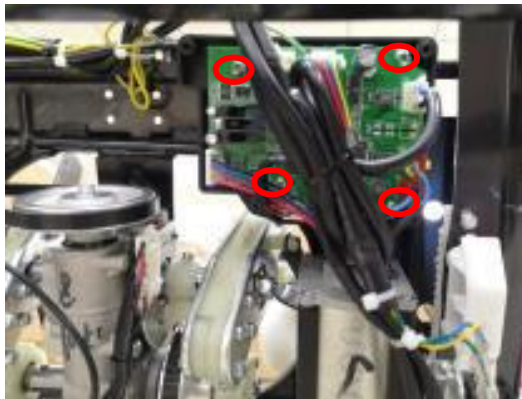

remove 4 screws fixing the PCB

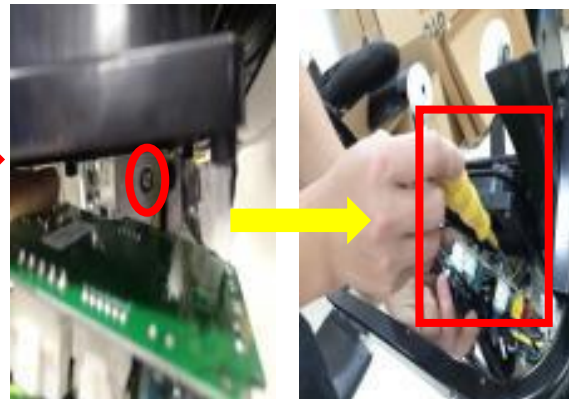

Use a slotted screwdriver to rotate the travel motor anticlockwise, and let the mechanism come out

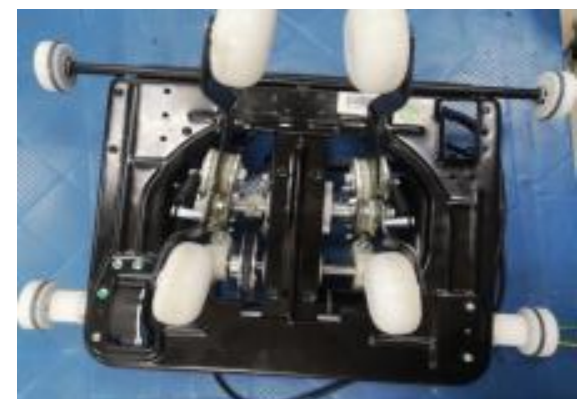

the mechanism



### 3.8、disassembly of the remote control:



disconnect the terminal

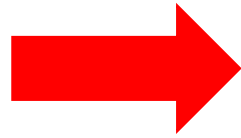

take down the remote control

**3.9、disassembly of the main PCB box (main PCB、Bluetooth PCB、transformer、5 ways air valve) :**



unzip the zipper and remove 6 screws



open the main PCB box

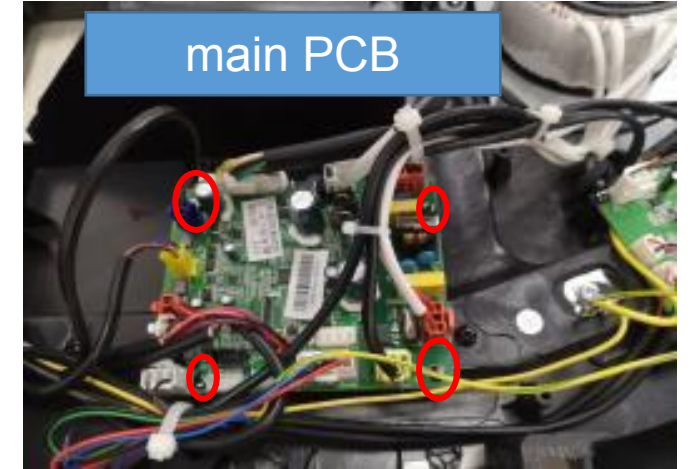

main PCB

remove 4 screws and disconnect all terminals

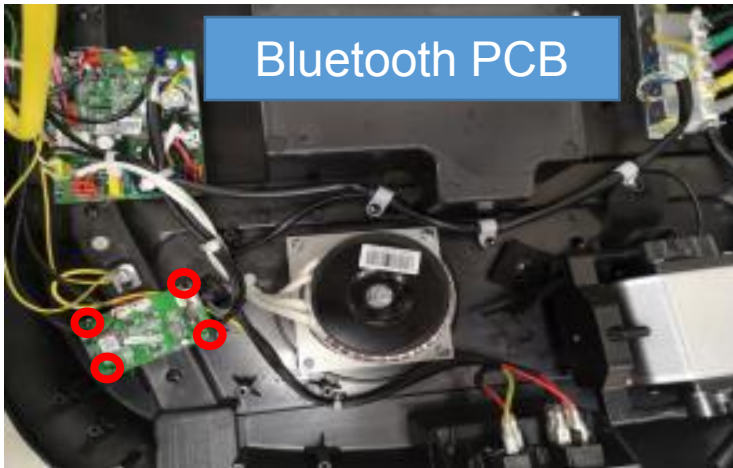

Bluetooth PCB

remove 4 screws and disconnect all terminals

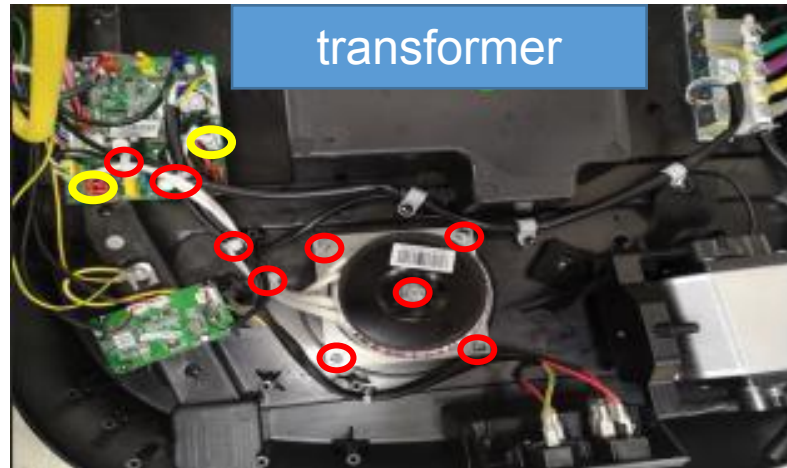

transformer

disconnect 2 terminals and remove the screw, cut the cable tie, take down transformer

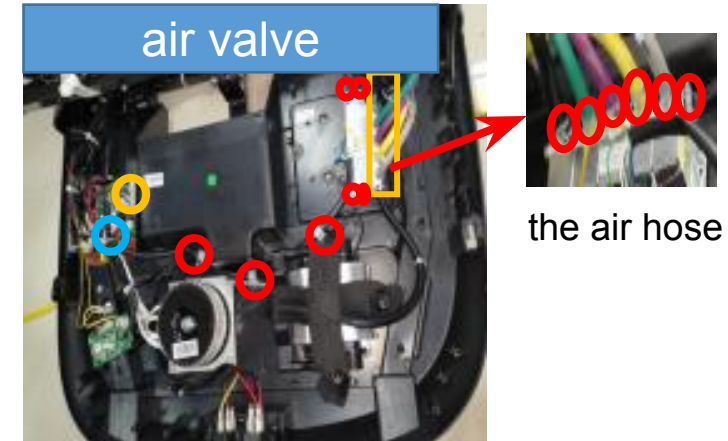

air valve

the air hose

disconnect the terminal and air hose, remove 4 screws of the air valve



### 3.9.1、disassembly of the main PCB box (air pump):

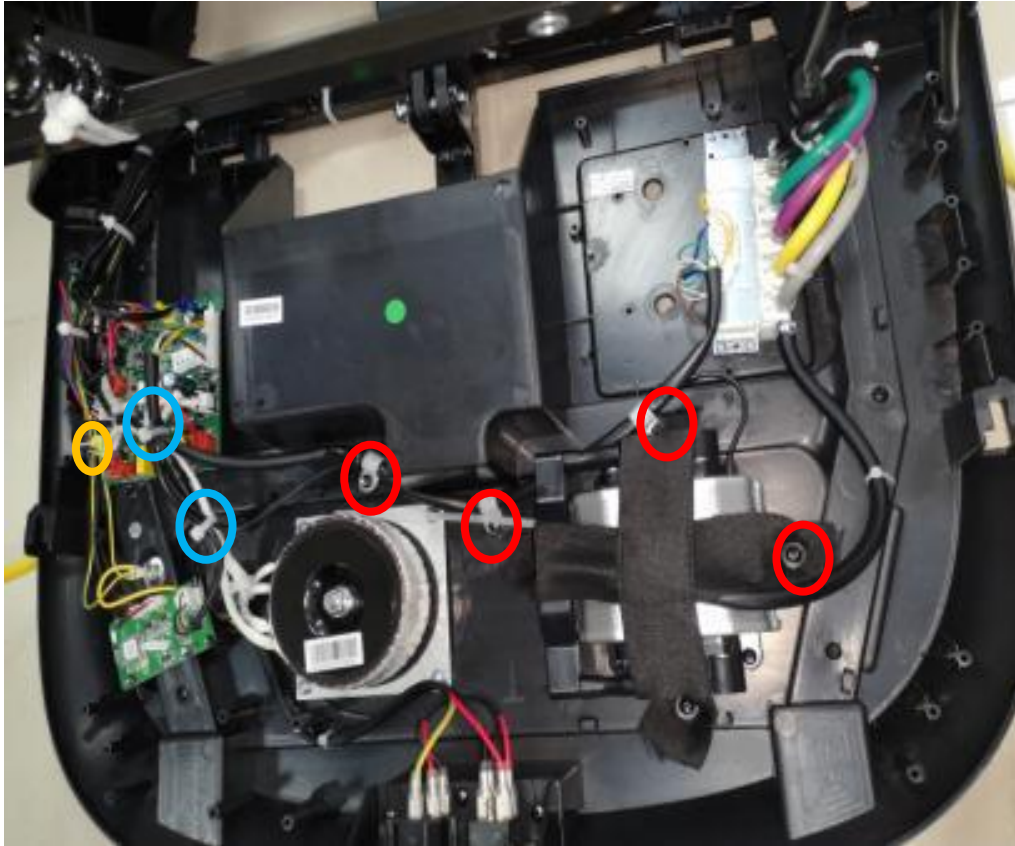

remove 4 screws (red mark), cut the cable tie (blue mark), disconnect yellow terminal (yellow mark)

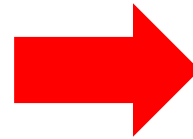

cut cable tie, disconnect air hose, take down air pump



### 3.10、disassembly of the backrest cable :

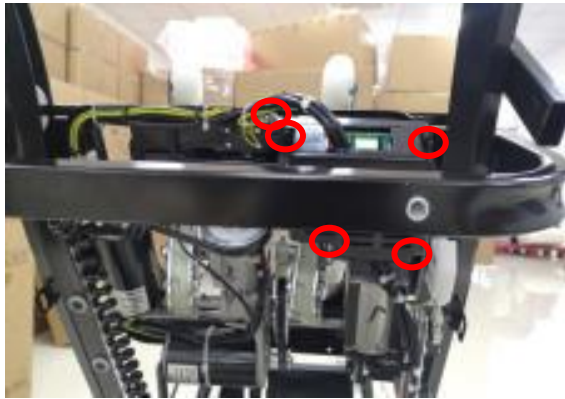

remove 1 screw fixing ground wire and 4 screws fixing the box

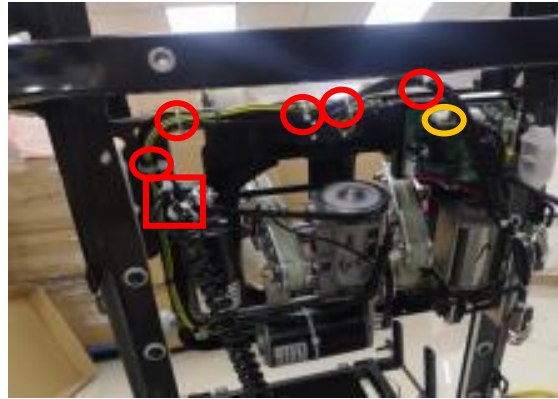

cut the cable tie (red mark), disconnect white terminal (yellow mark)



cut the cable tie



cut the cable tie

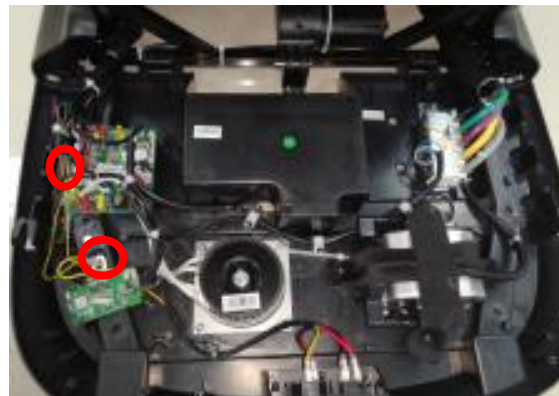

disconnect the terminal, remove the ground wire



take down backrest cable

**3.11. disassembly of backrest actuator: (remove backrest cover and main PCB box cover)**  
**one person should hold the backrest at the rear to prevent injury!**



disconnect the yellow terminal and cut the cable tie

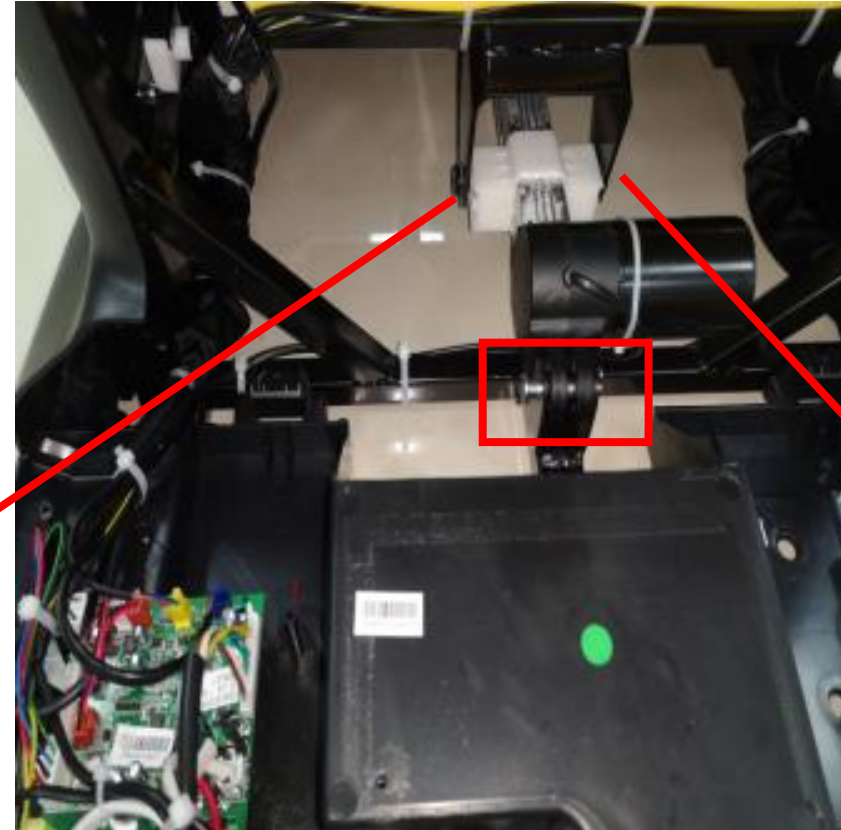
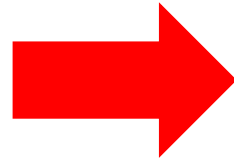

remove 2 screws and the shaft then remove the actuator





### 3.12、disassembly of legrest actuator:



unzip the zipper of the inner cloth

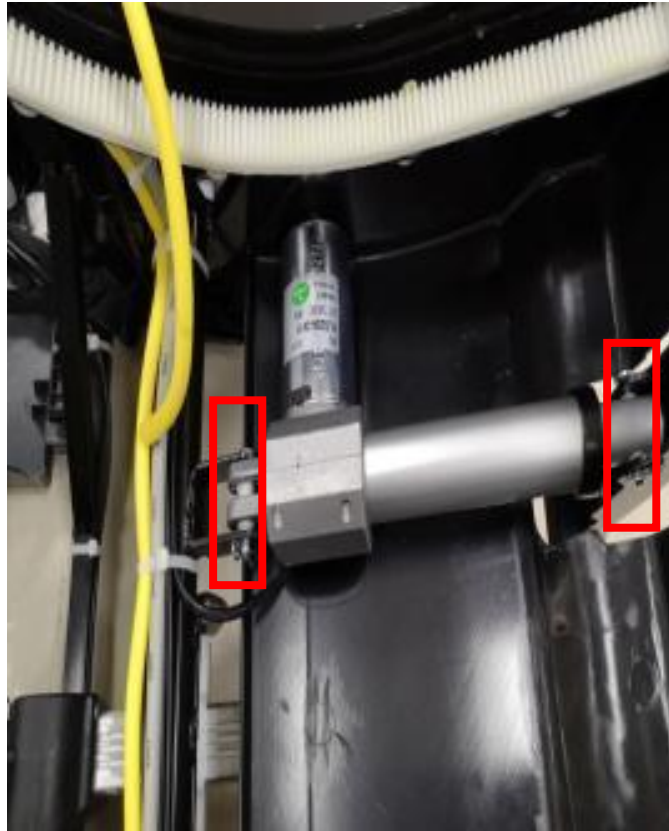
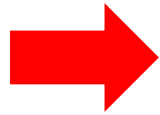

remove 2 shaft

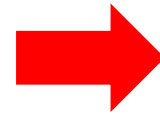

disconnect blue terminal and cut the cable tie (yellow mark), take down the actuator

### 3.13、disassembly of legrest unit (upper legrest unit) :



Lift the upper legrest and unzip the zipper

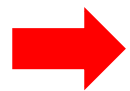

remove 4 screws take down the cover



remove 7 screws and take down the cover

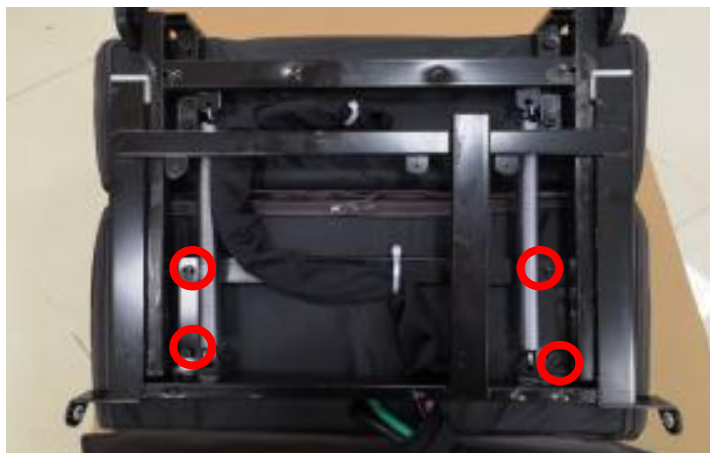

remove 4 screws



take down upper legrest



unzip the zipper then we can take down the leather

### 3.13.1、disassembly of legrest unit (lower legrest unit) ::



Lift the upper legrest and unzip the zipper



remove 4 screws take down the cover

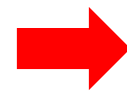

remove 7 screws and take down the cover

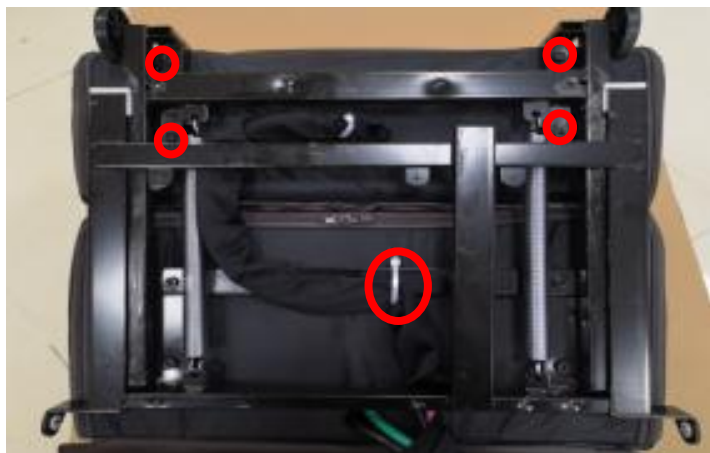

remove 4 screws, cut cable tie



take down lower legrest



remove 4 screws of the door mat, unzip the zipper, take down the leather



### 3.13.2、disassembly of legrest (foot massage) :



open the leather



remove 13 screws as the picture marked

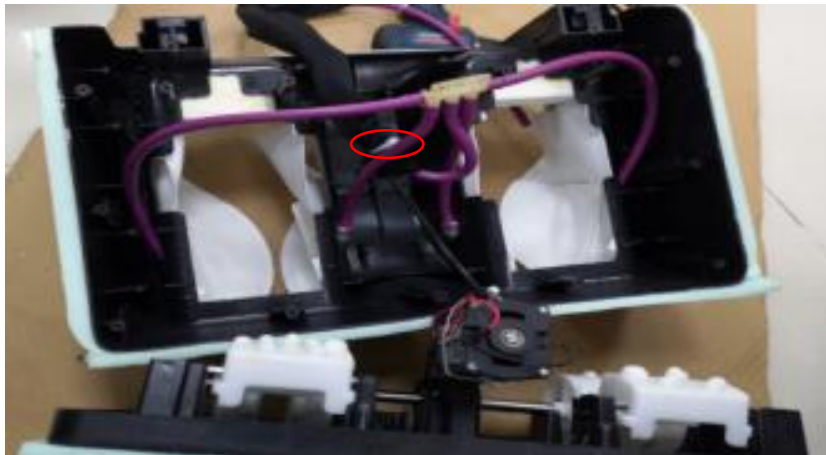

cut the cable tie

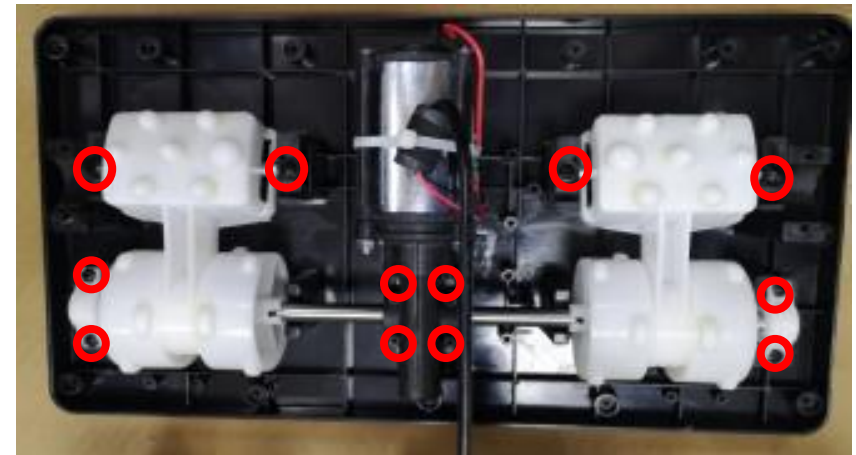

remove 12 screws and take down foot Massage



### 3.14、disassembly of the mechanism (kneading motor) :

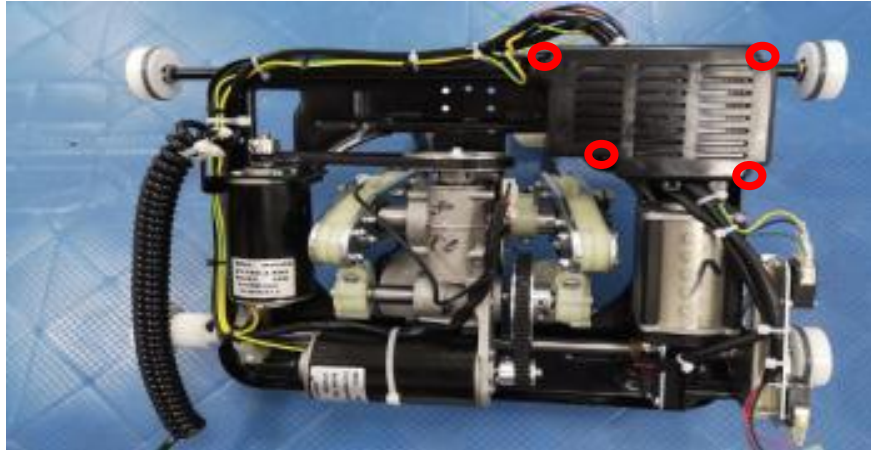

remove 4 screws and open the box

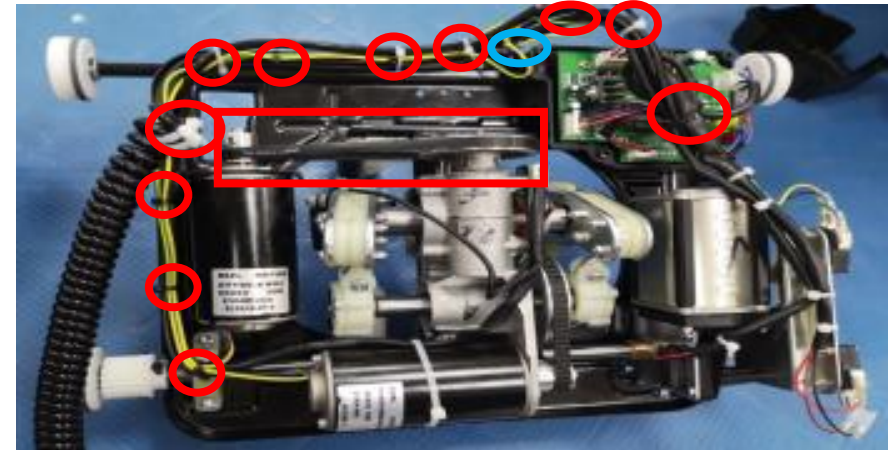

cut the cable tie (red mark), remove ground wire (blue mark)

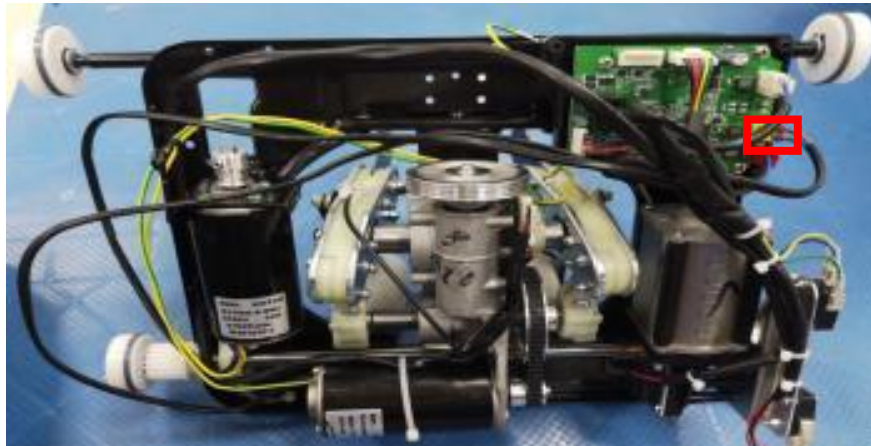

disconnect yellow terminal

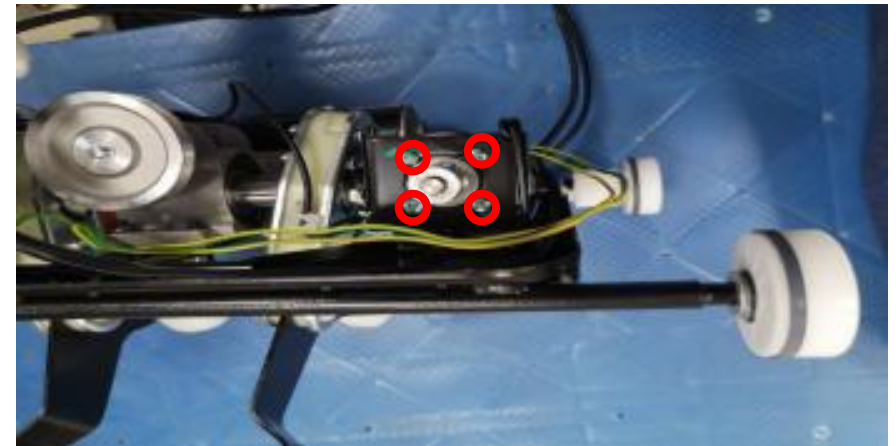

remove 4 screws and take down kneading motor

### 3.14.1、disassembly of the mechanism(tapping motor) :

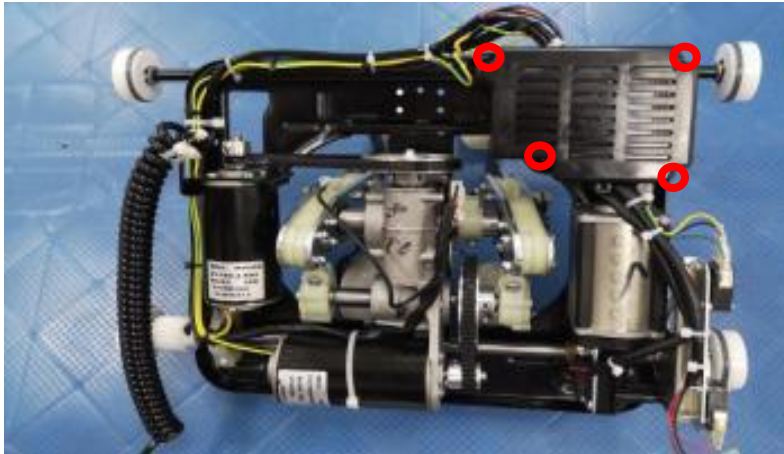

remove 4 screws and open the box

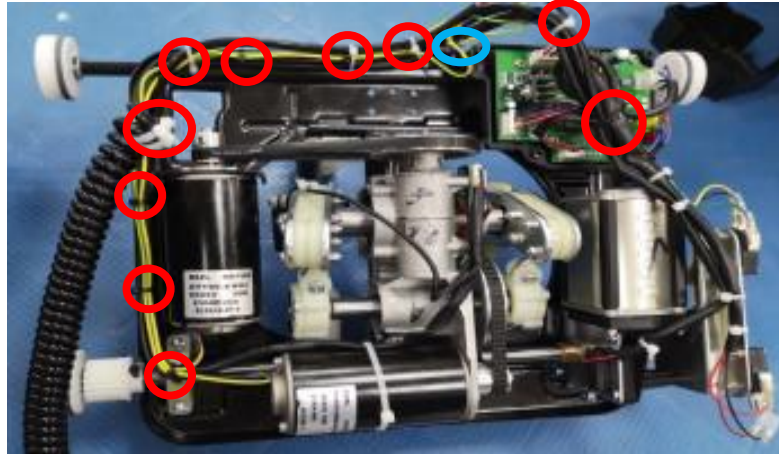

cut cable tie (red mark), remove ground wire

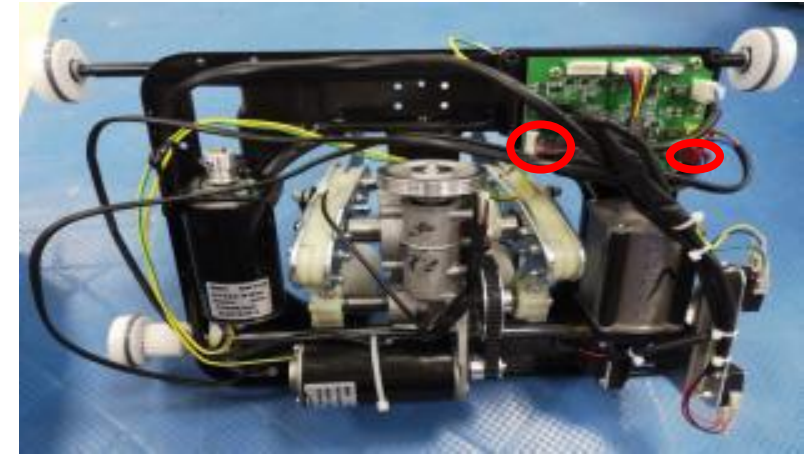

disconnect 2 terminals

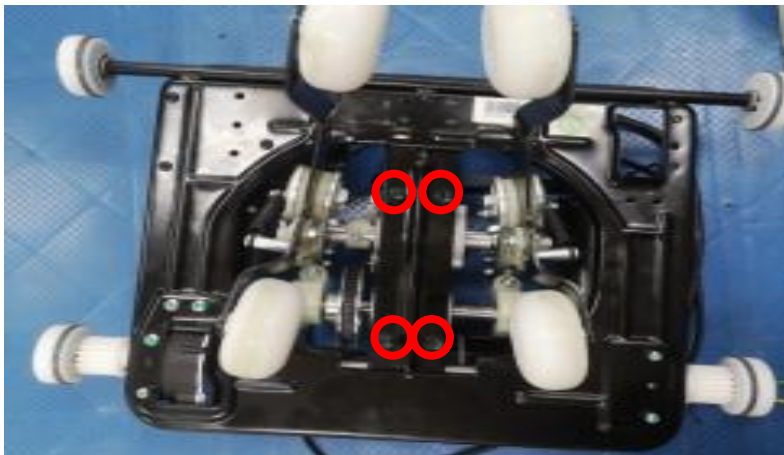

remove 4 screws



take down the mechanism



remove 4 screws and take down tapping motor



### 3.14.2、disassembly of the mechanism(rolling motor) :



remove 4 screws and open the box



cut cable tie (yellow mark), disconnect 2 terminal (blue mark), remove 6 screws (red mark)

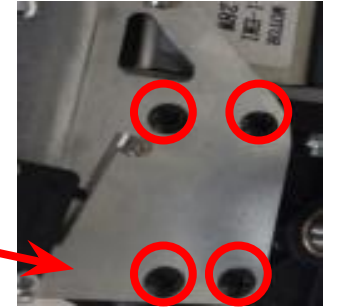

remove 3 screws



rolling motor unit



### 3.14.3、disassembly of the mechanism (mechanism PCB、up&down sensor) :

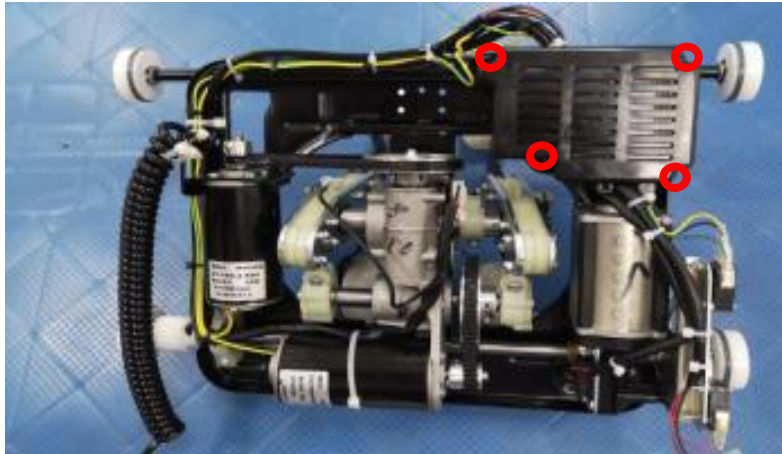

remove 4 screws and open the box

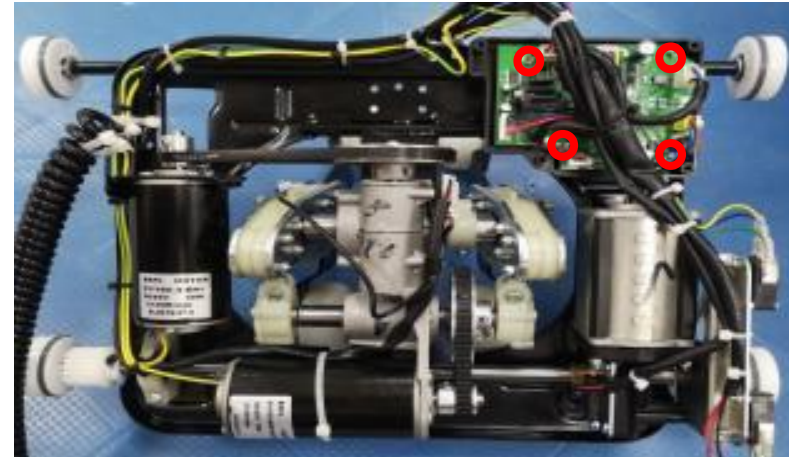
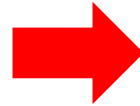

remove 4 screws and disconnect all terminals, take down CPB

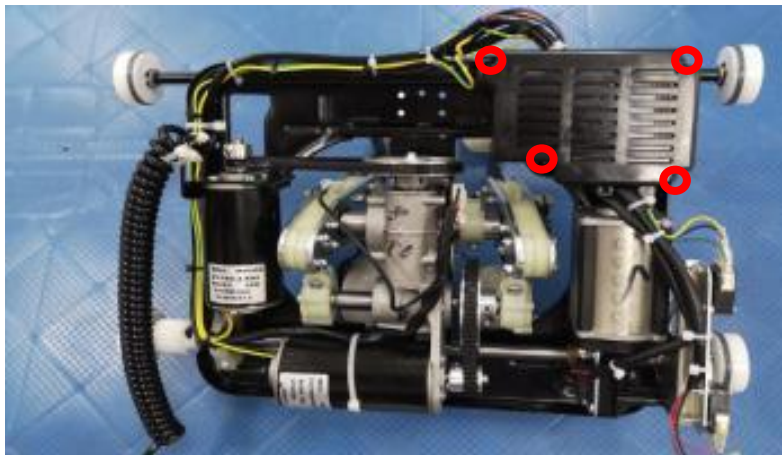

remove 4 screws and open the box

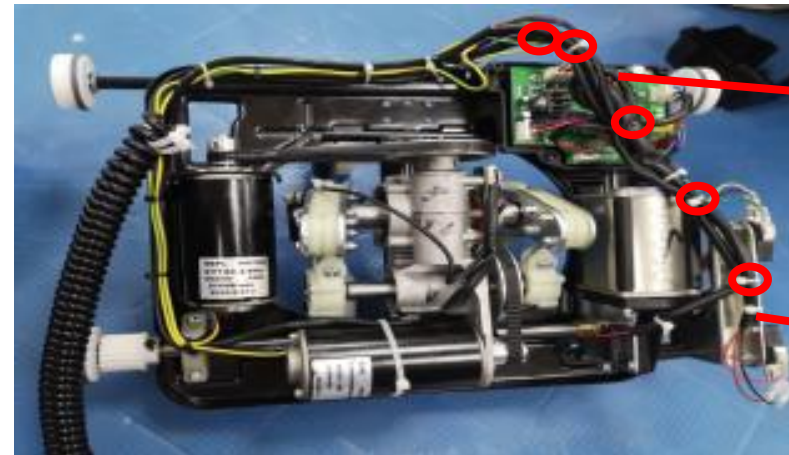
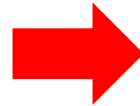

cut cable and disconnect the terminal, remove the screws and take down the sensor

