

Osaki
P L A T I N U M
Instruction Manual

OP-Vera 3D Plus



Contents



Important safety instructions	2
Product parts	8
Before use.....	10
The controller instructions	14
Operation guide	15
After massage	27
Cleaning and maintenance	28
Q & A	29
Troubleshooting	30
Specification	32

Important safety instructions



Must be followed



These safety instructions must be strictly followed in use to avoid personal injuries and property damage :

■ All the safety instructions are described in compliance with degrees of the injuries or damage as a result of wrong use.

 Warning	Actions leading to cause serious injuries or death
 Caution	Actions leading to cause minor injuries or property damage

■ Pay attention to the symbols before safety instructions (an example is given below).

 Actions that must be absolutely forbidden	 Actions that must be done
---	---

 Warning	
 Must be followed	<p>● IMPORTANT SAFETY INSTRUCTIONS When using an electrical appliance, basic precautions should always be followed, including the following: Read all instructions before using (this appliance).</p>
	<p>● DANGER-To reduce the risk of electric shock:</p> <ul style="list-style-type: none"> • Always unplug this appliance from the electrical outlet immediately after using and before cleaning. • Never use pins or other metallic fasteners with this appliance. • Carefully examine the covering before each use. Discard the appliance if the covering shows any sign of deterioration, such as checking, blistering or cracking. • Keep Dry-Do not operate in a wet or moist condition.
	<p>● WARNING-To reduce the risks of burns, fire, electric shock or injury to persons:</p> <ul style="list-style-type: none"> • An appliance should never be left unattended when plugged in. Unplug from outlet when not in use and before putting on or taking off parts. • Close supervision is necessary when this appliance is used by, on, or near children, invalids, or disabled persons. • Use this appliance only for its intended use as described in this manual. Do not use attachments not recommended by the manufacturer. • Never operate this appliance if it has a damaged cord or plug, if it is not working properly, if it has been dropped, damaged or dropped into water. Return the appliance to a service center for examination and repair. • Do not carry this appliance by supply cord or using cord as a handle. • Keep the cord away from heated surfaces. • Never operate the appliance with the air openings blocked. Keep the air openings free of lint, hair and the like. • Never drop or insert any object into any opening. • Do not use outdoors. • Do not operate where aerosol (spray) products are being used or where oxygen is being administered. • To disconnect, turn all controls to the off position then remove plug from outlet. • Keep children away from extended foot support. • Connect this appliance to a properly grounded outlet only. See Grounding Instructions. • Use heated surfaces carefully. May cause serious burns. Do not use over insensitive skin areas or in the presence of poor circulation. The unattended use of heat by children or incapacitated persons may be dangerous. • Do not operate under blanket or pillow. Excessive heating can occur and cause fire, electric shock or injury to persons. <p>SAVE THESE INSTRUCTIONS</p>
	<p>● Persons with the following conditions or under these medical treatments, should consult a physician before using this appliance.</p>

⚠ Warning

- | | |
|---|--|
| <ul style="list-style-type: none"> (1) Persons with a pacemaker cannot use this product. The chair may cause an electronic malfunction to the medical device; (2) Patients with malignant tumors; (3) Patients with heart disease; (4) Persons unable to feel or insensitive to heat on their skin such as a diabetic patient; (5) Pregnant women or ones that have just given birth; (6) Persons with poor blood circulation such as a diabetic patient; (7) Osteoporosis patients, spinal fracture patients or persons with acute painful disease or injuries such as joint sprains or muscle strains; | <ul style="list-style-type: none"> (8) Persons with any injuries should not use this appliance; (9) Persons with higher or lower body temperature, fever, inflammation, cold symptoms, high blood pressure or any poor health conditions should consult a physician before using this product; (10) Avoid falling asleep in this chair; (11) Any one with spinal or nerve conditions; (12) Persons with protrusion of intervertebral disc; (13) Do not wear loose clothing or jewelry as it might get caught with massage mechanism; (14) Keep long hair away from moving massage mechanism while in use. |
|---|--|

Otherwise discomfort or even physical injuries may occur.



- **If you feel unwell while using or after using the chair, stop immediately and contact your physician. Do not use the chair again unless approved by your doctor.**
- **Before operating or adjusting the chair, be sure that there are no obstructions that can cause damage to your chair. No pets or persons, near, in front or under the chair to avoid serious injury.**
- **Before using the chair, lift up the backrest pad and check the middle cover area where the massage rollers travel up and down. Be sure the middle nylon cover is not unzipped and has no signs of damage or tear caused by the roller heads. Using the chair while the roller heads are exposed could cause physical injury and electrical shock.**
- **When using the chair for the first time, it is recommended that you select the “Demo” mode to get familiar with various massage features of the chair.**
- **Do not use the chair for more than 30 minutes each time.**
- **Do not massage a single part of your body for more than 5 minutes.**
- **Failing to follow these instructions, discomfort or even physical injuries may occur.**
- **After using the chair, it is recommended that the chair is unplugged from the power outlet to avoid any surges caused by outages. It is HIGHLY ADVISABLE TO ALWAYS USE A SURGE PROTECTOR. Keep children or minors from using the chair without supervision to avoid misuse that could result in serious injuries.**
- **Follow the local code and regulations about use of electrical products.**
- **Use a 110V-120V, 60Hz power supply. (Do not use the chair in a country this product is not designed for or connect it with a transformer.) It may lead to electrical shock, product failure or internal components overheating causing fire hazard.**
- **Make sure the power cable is firmly plugged into the outlet to avoid power surges, short and electrical shocks. Electrical shocks may cause internal component overheating causing fire hazard.**
- **Wipe and clean the power plug regularly with dry cloth to avoid dirt or moisture built up.**





- **In the case of any abnormality with functions of the chair, stop using the chair immediately and pull out the power plug to avoid smoke, fires and electric shocks.**
Abnormality and fault examples
- **If the chair is plugged in and the power switch is in the “ON” position and if the chair is not responding.**
- **When the chair is turned off but still operating.**
- **If you detect any burning smell or abnormal sounds.**
- **If you detect any parts of the upholstery that seemed to have melted due to over heating.**
- **In any of these listed issues have occurred STOP using the product and unplug from the power outlet. Have the product inspected by an authorized service center.**



- **Do not put any cushions or obstructions between the backrest pad and the backrest. This may damage the mechanism and result in personal injury.**
- **When moving or handling the chair, be sure to hold onto the recommended supported area. Otherwise parts of the chair may break resulting in serious injury.**

Warning

 Forbidden	<ul style="list-style-type: none"> ● People with the following health issues should NOT use this chair: Persons for whom massage is not advisable by doctors. Such as persons with thrombosis, serious aneurysm, acute venous aneurysm, various skin inflammations (such as subcutaneous tissue inflammation) or various skin infections. Otherwise it may aggravate or cause serious injury.
	<ul style="list-style-type: none"> ● Anyone with physical injuries or poor health should NOT use this product. Persons with acute lumbago, protrusion of intervertebral disc or displacement of a lumbar vertebra. Otherwise it may aggravate or cause serious injury.
	<ul style="list-style-type: none"> ● Do not put hands, arms or feet into the traveling massage mechanism while the chair is operating. ● Keep small children away from the chair. Climbing could result in falls that could lead to serious injuries. ● Do not climb onto the backrest or the armrests. ● Do not apply excessive pressure leaning back on the backrest. ● Keep your head away from reachable areas of the backrest and the back cover. ● Young persons or persons with physical disabilities that can not operate the chair on their own, should not use this product or without supervision. Anyone with weakened physical conditions should consult a doctor before using the chair. ● When massaging the neck area, pay attention to the intensity of the massage and make sure it does not hurt the neck muscles or nerves.
	<ul style="list-style-type: none"> ● Do not damage the power cord. Do not damage, alter, bend, twist or use it with any extension cords. Do not place the power cord close to a heater. A damaged power cord may result in electric shocks, short circuit or fires. Please consult with the retailer/dealer from which you bought the product or a designated authorized service center about maintaining your power cord.
	<ul style="list-style-type: none"> ● When engaging the heat function of massage wheels, avoid prolong contact with the skin in one position. Otherwise low-heat burns may occur. Even if the temperature is relatively lower at 40 °C~60 °C, low-heat burns may happen in spite of no obvious hot or painful sensation.
 Wet-hand operation forbidden	<ul style="list-style-type: none"> ● Do not insert or pull out the power plug when your hands are wet. Otherwise electric shocks may happen.
 Disassembly forbidden	<ul style="list-style-type: none"> ● Do not refit, disassemble or repair the product without the help of an authorized service provider. Otherwise fires, abnormal movements or personal injuries may happen.

Caution





Must be
followed

- The following persons (even if they are physically healthy at present) should consult a physician before using the product.
 - (1) Persons with muscular atrophy due to old age or below normal weight;
 - (2) Persons feeling lumbago with pain in the muscles and joints of the lower back;
 - (3) Persons suffer from sprains or bruising easily;
 - (4) Persons with motion sickness;
 - (5) Persons who received a heart operation or another vascular operation.It may cause serious injury if not addressed properly.
Otherwise it may aggravate or cause serious injury.
- Before sitting on the product, make sure there is no foreign objects between any two parts of the chair.
(Make sure there are no foreign objects on the back cover, the backrest, the seat surface, the lower leg/foot massage section or inside surface of the back cushion.)
Otherwise accidents, injuries or product faults caused by clamping of hands, feet or other articles may occur.
Before sitting on the seat, make sure the massage wheels are in the retracted positions.
- Turn off the massage function before you get off the chair.
- When the lower leg/foot massage section is not retracting after the massage, retract the footrest with the remote button.
- When unplugging the chair, always hold onto the plug and not the cord to avoid damaging the power cord. Damaged cord could result in shock and serious injuries.
- Before moving the chair, be sure the backrest is up and the footrest is retracted in default positions.
Otherwise injuries may happen.
- When moving the product by dolly, lay mats on the floor to avoid markings or damage to the floor. Do not roll the chair on engineered wood or soft wood floorings. Otherwise marks and damage may occur.
- Keep the safety lock key.
Keep children away the remote control.
- Before moving the chair, make sure there are no obstructions around. If lifting is required, make sure to lift from the steel frame of the chair. Be sure to maintain good balance or the heavy chair could tip and fall on the movers, causing serious injuries.
- Symptoms such as skin inflammation, itching or swelling when using the chair, stop the using the product immediately and consult a physician.

Forbidden

- Do not use the product with other electrical devices at the same time, such as heating blanket.
- Do not place your hands, arms, feet or any parts of your body to massage area that are not designed for the body parts to avoid discomfort or injuries.
- Do not put the knees between the calf massager. This may cause serious injury.
- Do not fall asleep while using the product.
- Do not use the product after drinking alcohol.
- If the airbag on the seat is not completely deflated, do not stand or jump on the seat or put things on it. It could risk puncture.

⚠ Caution

 Forbidden	<ul style="list-style-type: none"> ● Do not put hands or feet between footrest and seat base. ● Do not put hands or feet between footrest and side panel. ● Do not put hands or feet between seat base and side panel. ● Do not put hands or feet between the upper and the lower part of the footrest. ● Do not put hands or feet in the gap of seat base. ● Do not put pets on the massage chair. ● Do not pull out the power plug or turn off the power switch suddenly during massage operation.
	<ul style="list-style-type: none"> ● Do not stand or sit on the back cover. The chair may topple.
	<ul style="list-style-type: none"> ● Do not stand or sit on the armrests.
	<ul style="list-style-type: none"> ● Do not stand or sit on the lower leg/foot massage section or the footrest.
	<ul style="list-style-type: none"> ● Do not drag or push the product after it is installed.
	<ul style="list-style-type: none"> ● Do not move the product while there is a person sitting on it.
	<ul style="list-style-type: none"> ● Do not use the product with other heating devices such as electric blankets. Otherwise fires may occur due to overheating.
	<ul style="list-style-type: none"> ● Do not leave the remote controller on the seat, always return it to its holder.
 Wet-hand contact forbidden	<ul style="list-style-type: none"> ● Do not place this chair in locations with high humidity such as the bathroom. Moisture will destroy electrical components resulting in product failure or worst, electrical shock and other serious injuries.
 Product wetting forbidden	<ul style="list-style-type: none"> ● Do not use any liquid aerosol sprays around the chair. Otherwise electric shocks, short circuit or product failure may happen.
 Pull out the power plug	<ul style="list-style-type: none"> ● Before cleaning or maintaining the product, always unplug the power cord.
	<ul style="list-style-type: none"> ● In the case of a power failure, pull out the power plug at once. It is highly recommended to plug chair into a surge protector to protect the chair from shorting during outages.
	<ul style="list-style-type: none"> ● When the product is not in used, pull out the power plug.

GROUNDING INSTRUCTIONS

This product must be grounded. If it should malfunction or break down, grounding provides a path of least resistance for the electric current to reduce the risk of electric shock. This product is equipped with a cord with an equipment-grounding conductor and a grounding plug. The plug must be plugged into an appropriate outlet that is properly installed and grounded in accordance with all local codes and ordinances. **Danger-Improper connection of the equipment-grounding conductor can result in a risk of electric shock. Check with a qualified electrician or serviceman if you are in doubt as to whether the product is properly grounded. Do not modify the plug provided with the product – if it will not fit the outlet, have a proper outlet installed by a qualified electrician.**

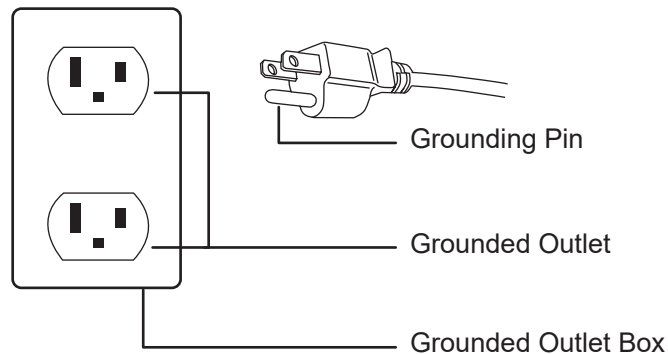

Product Parts

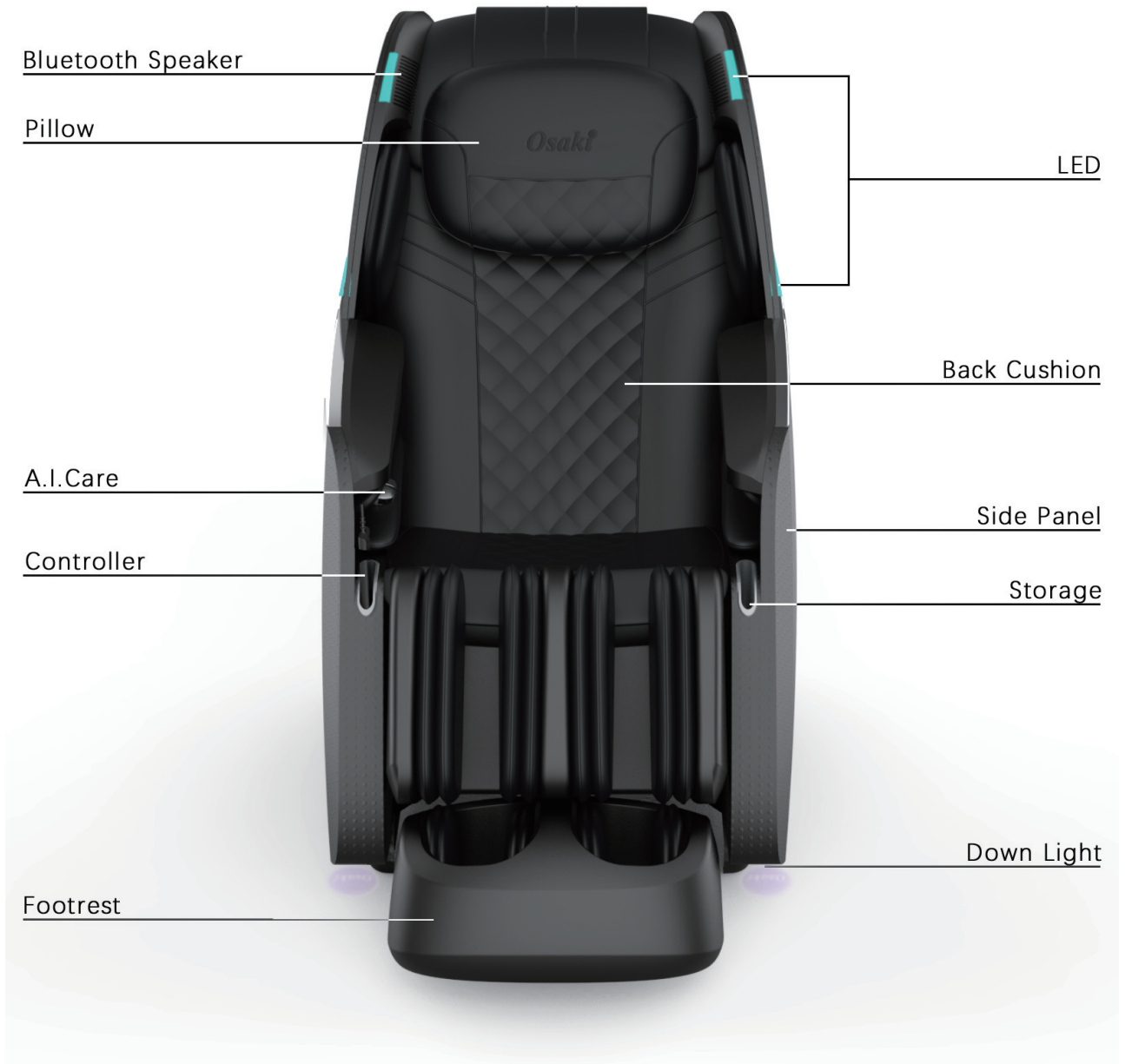

EN8

Product Parts

Air Bags Massage Position



■ Air bags ■ heating ■ foot roller

EN9

Before use

1 Before use (installation position)

- Make sure there is enough space to recline the chair and for the user to get in and out of the chair freely. PLEASE MAKE SURE TO USE A MAT OR RUG UNDER CHAIR IF YOU PLACE THE CHAIR ON TOP OF A HARD SURFACE LIKE HARWOOD AND CERAMIC FLOORS.

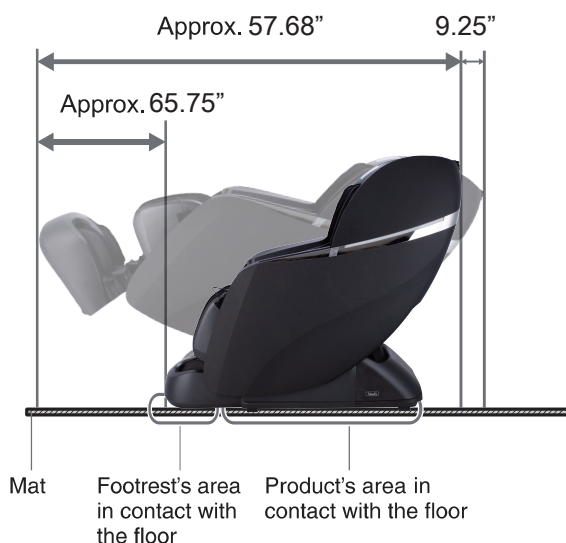

- Do not expose the product directly under the sunlight or in a high-temperature place (e.g., in front of heating equipment or by a window where sunlight can cause the synthetic leather fade, melt or crack.)
- Place a mat below the product to avoid floor damage. The mat should cover the product's area in contact with the floor and the footrest's area in contact with the floor (minimum dimensions: 63"x31.5"). See the figure.
- Install the product close to a power socket.

2 Check the space around the product.

Make sure there is no person, pet or other object close to the product.



EN10

3 Make sure there is no foreign objects in the seams of the product.

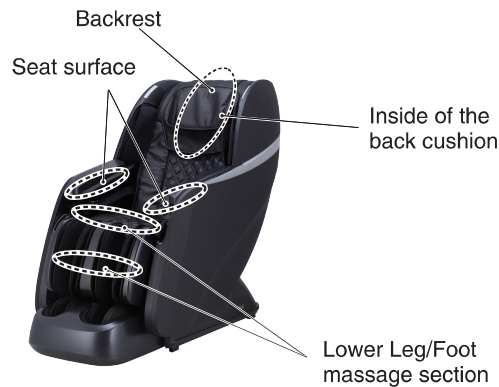

⚠ Caution

- Do not put hands or feet between footrest and seat base.
- Do not put hands or feet between footrest and side panel.
- Do not put hands or feet between seat base and side panel.
- Do not put hands or feet between upper and lower part of the footrest.
- Do not put hands or feet in the gap of seat base.
otherwise injuries may happen.

4 Inspect the power line and power plug

⚠ Warning

- Inspect the power cord of dirt or dust that may have collected. Be sure the cord is kept clean and with **NO visible damage**.

Otherwise the lint and dust may lead to an electrical fire. Wipe down the plug with dry cloth.

- Do not damage the power line or the power plug. Do not bend or twist the power cord for any reasons.
Do not place the power cable under heavy objects such as the chair itself. Keep the power cord away from any heating sources such as the heater vents, motors and anything that may generate heat.

A damaged power line or power plug may result in electric shocks, short circuits or fires.

Please consult the shop you bought the product or an authorized service center about maintenance method of the power line or the power plug.



Do not be entangled by the power line.

Make sure the plug is fully inserted.

5 Power on the product

- 1 Insert the power plug into the power socket.
- 2 Turn the switch to the "I" (ON) position to activate the chair.

Warning

- **Be sure the power cord is firmly and completely inserted into the power outlet.**
Otherwise electrical shocks or fires may occur because of overheating or power shorts.
- **Abide by the regulations on use of the socket and the wiring devices strictly.**
- **Use a 110-120V~, 50/60Hz power supply.**
(Do not use the product in a foreign country or connect it with a transformer without permission.)
Otherwise electric shocks, product faults or fires because of overheat may happen.
- **Do not insert or pull out the power plug with wet hands.**
Otherwise an electric shock may happen.

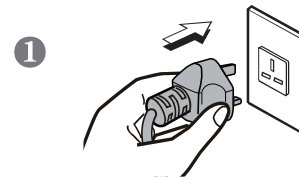

Before use (Continued)

6 Make sure the massage wheels are retracted



If the rollers are not at the top of the backrest in the retracted position, press "ON" button to bring back to the default position.

7 Make sure the fabric is not damaged nor cracked

Inspect the synthetic leather portion in which the massaging rollers travel along the backrest. Be sure there is no damage or unusual wear.



Warning

- Before use, raise the back cushion and check whether fabrics lining pointed out in the figure are undamaged. (Even if the fabric is slightly damaged, stop using the product immediately. Pull out the power plug and send notify the manufacturer for a replacement cover.)
If the product is used when there is fabric damage, you may get injured or get an electric shock.

The controller instructions



Operation Guide

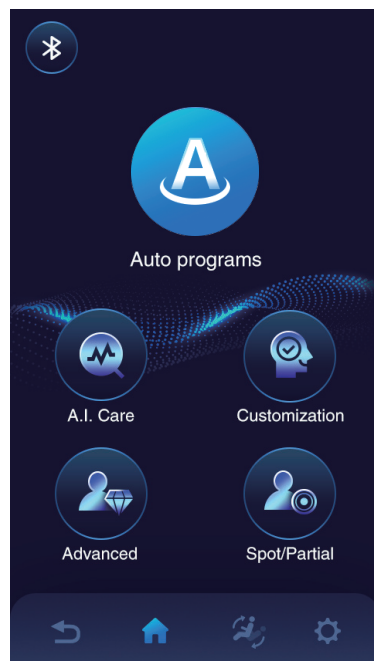

EN14

Operation guide



1. Auto programs:

- Touch this icon, the screen will turn to the [Auto] page.
- There are 8 auto massage programs. Select one of them to start the massage.

- Rejuvenate** : Focus on full body, various massage ways will let whole body feel relax.
- Shiatsu** : The muscles around your neck and lower back will be loosened by soft kneading and strong tapping.
- Swedish** : The muscles around your lower back, waist, hips will be loosened by kneading, clapping, and swedish.
- General Wellness** : Specially designed for the aged, massage with soft kneading and soft clapping.
- Deep Tissue** : This program will start kneading and tapping to relieve stress on neck and full body.
- Gentle Touch** : This program will start with slow kneading massage, let your body feel comfort.
- Sports** : The program will be especially effective in reducing muscle aches and fatigue.
- Relax** : This program will start with kneading and tapping massage for waist and lower back area.
- Neck & Upper Back** : Target at neck, and reducing neck muscle aches and fatigue.
- Hip Flexor** : Target at waist and hip, and reducing muscle aches and fatigue.
- Thai** : This program will stretch full body.
- Sleep** : Gentle relaxation course based on soft kneading helps you to fall asleep.

NOTE:

Foot Roller:

- Press once, to activate the roller massage. Press again, to stop the roller massage.

Heating:

- Touch this icon to turn off the heating from the rollers. Touch again to turn it on.
- In auto massage mode, the heating will set to default.

3D Mechanism:

- There are 6 adjustable levels for the 4D mechanism intensity.
- In auto massage mode, the mechanism intensity will set to default.

Adjust:

- Intensity/ Strength/ Speed: There are 5 different levels for adjustment.

3D+ Sonic Massage:

- Press once, to activate high frequency tapping. Press again, to stop tapping.

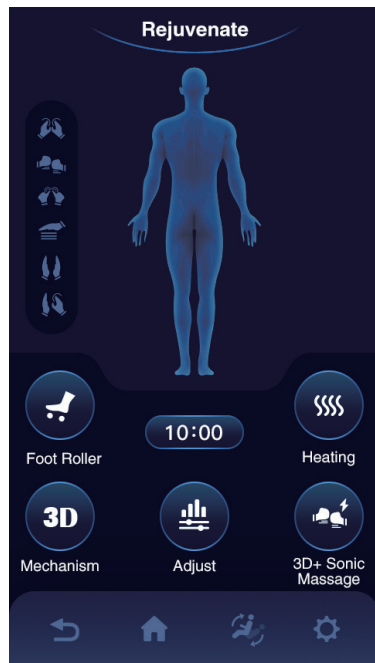
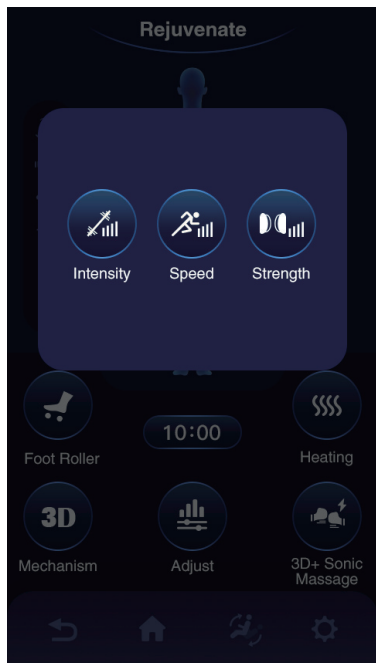
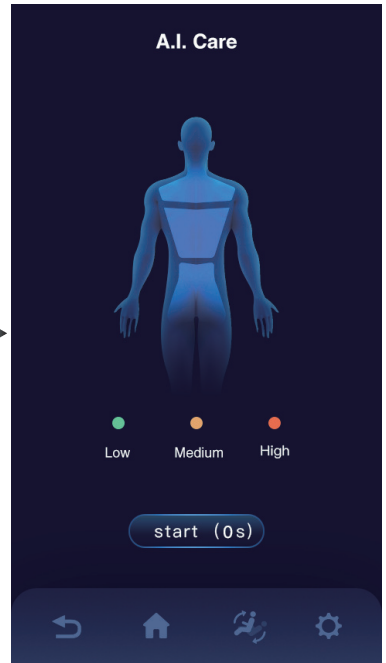
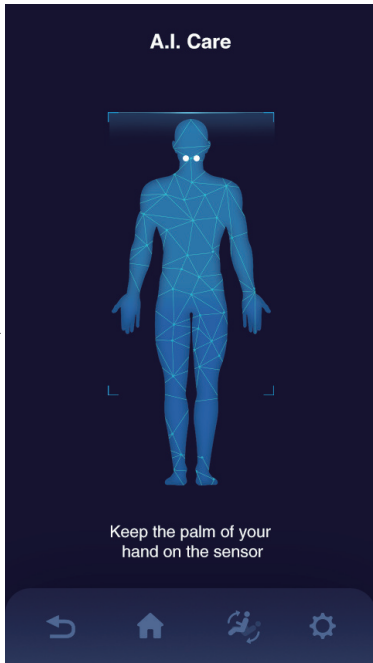
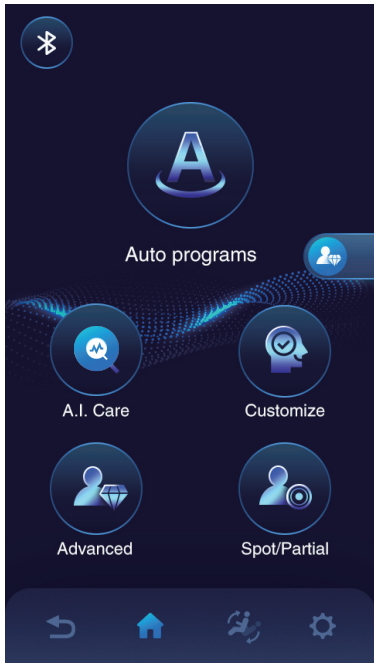

A.I. Care(artificial intelligence care)

- Touch the A.I. Care icon and the screen will turn to the next page showing you how to detect your health pro.
- You need to lean back and keep the palm of your hand on the sensor to make sure all the testing points are covered. Press the button to start detection.
- You'll be prompted to firmly press your palm against the electro plate, do not remove your palm until you receive the Health Pro diagnostics screen.
- It will show your health condition:light, medium or heavy. The chair will generate massage programs automatically according to your health condition scanning status.

NOTE:

- In order to use A.I. Care properly to scan your body, you must lean against and make good contact with the electro plates of the body pain detector or it will stop and scanning will fail.

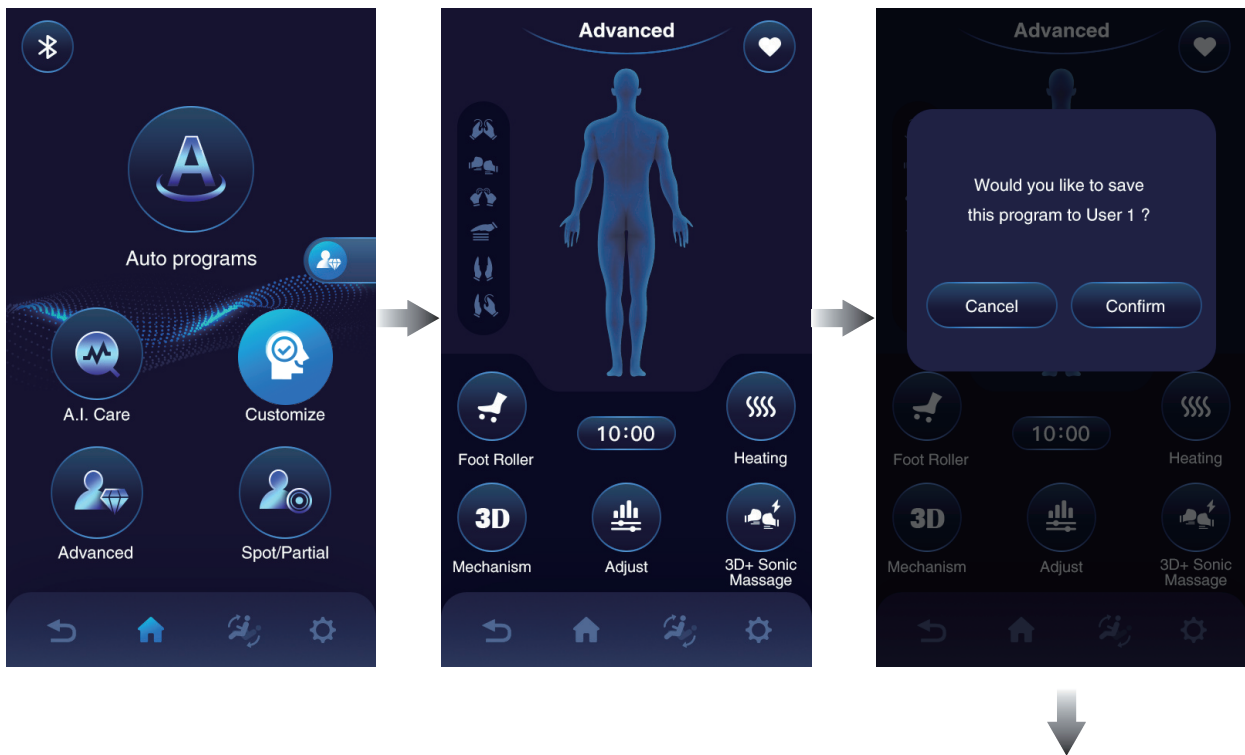

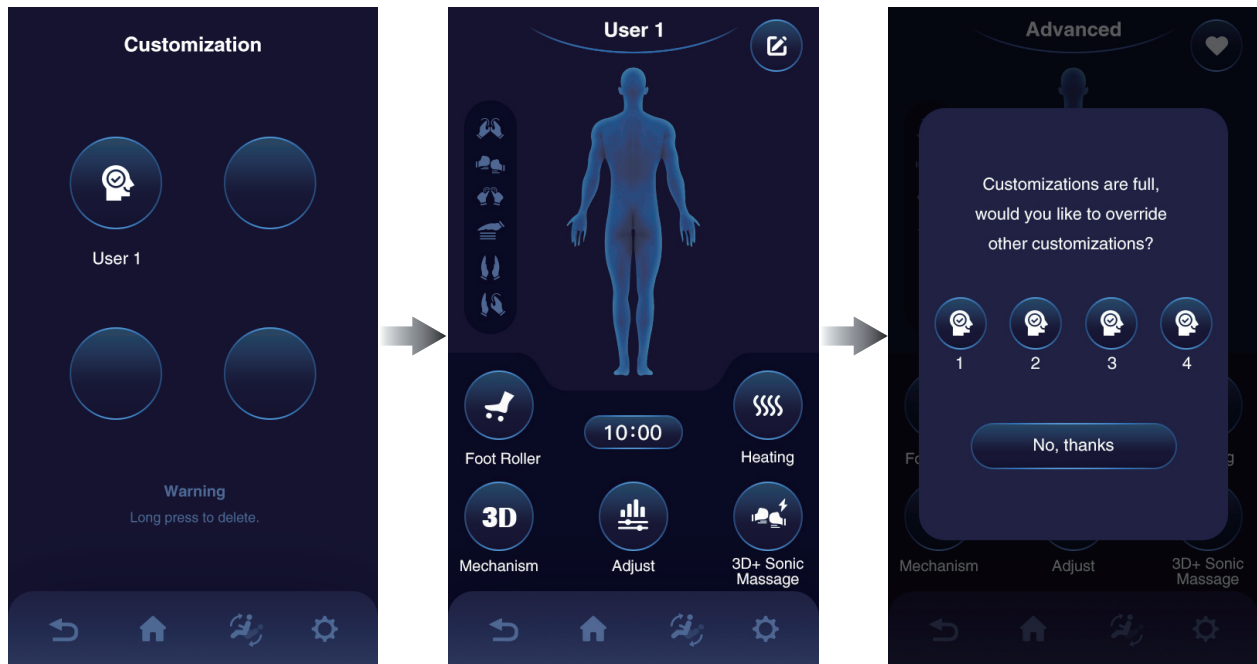

Customization

- User can design message program for themselves, then save the program for their own.
- Firstly open Advanced, then edit message program (Manual Massage, Air Massage, Area Massage), then touch  to save the program as User X. And you can also re-edit directly User X.
- Customization can save User 1, User 2, User 3, User 4. If you want to save more new program, controller will remind you Customizations are full, would you like to override other customizations.

Note

Foot Roller:

- Press once, to activate the roller massage. Press again, to stop the roller massage.

Heating:

- Touch this icon to turn off the heating from the rollers. Touch again to turn it on.
- In auto massage mode, the heating will set to default.

3D Mechanism:

- There are 6 adjustable levels for the 4D mechanism intensity.
- In auto massage mode, the mechanism intensity will set to default.

Adjust:

- Intensity/ Strength/ Speed: There are 5 different levels for adjustment.

3D+ Sonic Massage:

- Press once, to activate high frequency tapping. Press again, to stop tapping.

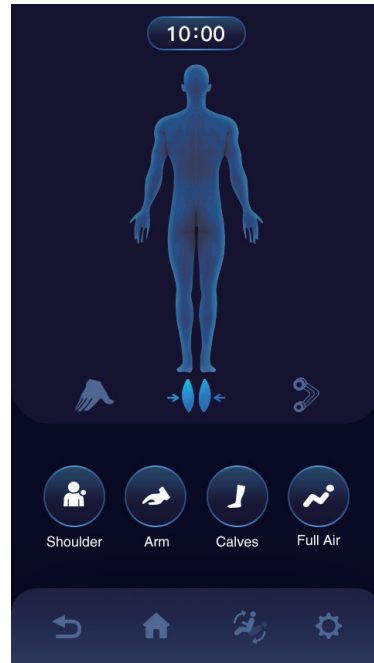
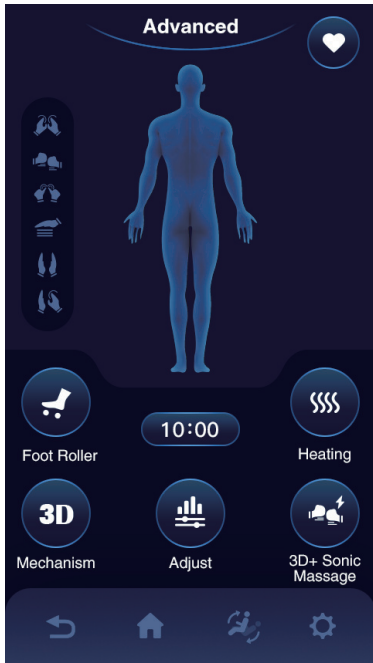
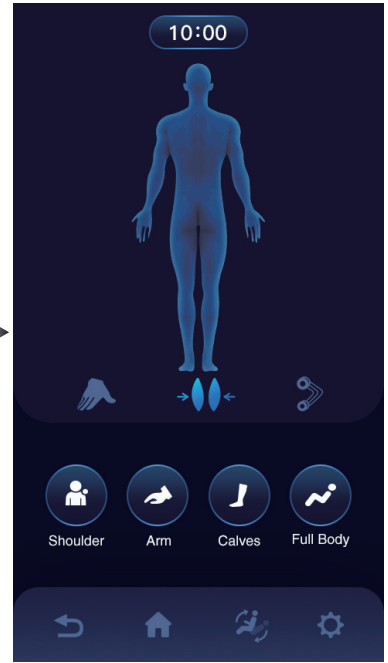
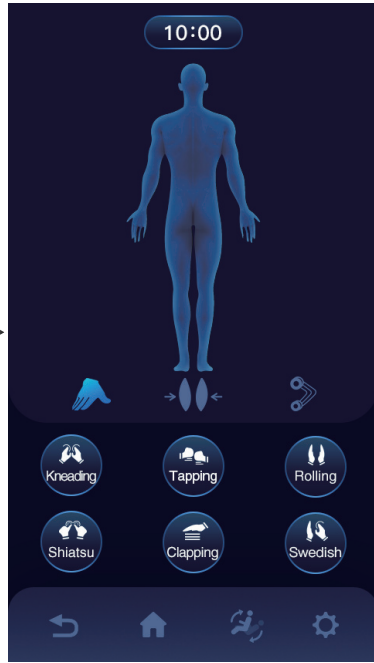
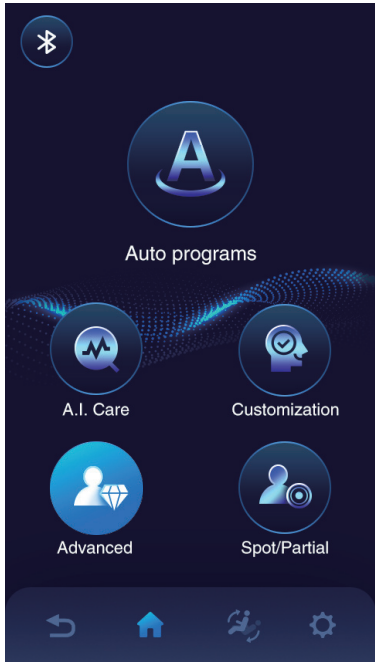

EN20

Advanced Manual Massage

● **Kneading**

- This button activates the Kneading massage modes. There are 2 Kneading modes.
- Press once to activate the full back massage of Kneading Mode 1; press again for Kneading Mode 2.
- Press again to stop.

● **Tapping**

- This button activates the Tapping massage mode.
- Tapping massage can be adjusted to fit 3 widths and 5 speeds.
- Press once to activate the Tapping Mode 1 for a continuous full back massage at medium speed. Press again to enter Tapping Mode 2 for an interval full back massage.
- Press again to stop.

● **Rolling**

- This button activates the Rolling massage mode.
- Rolling massage can be adjusted to fit 3 widths.
- Press once to activate the Rolling massage mode for a full back massage.
- Press again to stop.

Note: Rolling massage cannot be used to perform "Spot" massage.

● **Shiatsu**

- This button activates the Shiatsu massage mode.
- Shiatsu massage can be adjusted to fit 3 widths and 5 speeds.
- Press once to activate Shiatsu Mode 1 for a continuous full back massage. Press again to enter Shiatsu Mode 2 for an interval Shiatsu massage.
- Press again to stop.

● **Clapping**

- Clapping Function Start/Stop Control Button-3 size of width,5 levels of speed to be adjusted.
- Press this button once to activate the clapping function for a full back massage at medium speed.
- Press this button again to stop the clapping massage function.

● **Swedish**

- This button activates the Swedish massage mode.
- Swedish massage can be adjusted to fit 5 speeds.
- Press once to activate Swedish Mode 1 for a continuous full back massage. Press again to enter Swedish Mode 2 for an interval Swedish massage.
- Press again to stop.

Air Massage

● **Shoulder**

- This button allows you to activate the air pressure massage mode at your Shoulders. Press once to start, press again to stop.

● **Arms**

- This button allows you to activate the air pressure massage mode at your Arms.
- Press once to start, press again to stop.

● **Calves**

- This button allows you to activate the air pressure massage mode at your Calves.
- Press once to start, press again to stop.

● **Full Air**

- This button engages the Full Body Air Pressure Auto Program.
- Press once to start.
- This program applies full body air pressure massage to the head, neck, shoulder, arm, palm, lower back, buttocks, thighs, calves and feet.
- The default massage session is 15 minutes.

Area Massage

● **S/P (Spot/Partial)**

- Press once to localize the massage to a spot point.
- Press again to shift massage to a particular area of body.
- This will keep the original massage node working on a range of 8cm.
- To resume full back massage, press button again.

● **Full Body**

- This button controls the massage for full body.
- Press once, to activate the full body massage.
- Press again, to stop the full body massage.

● **Width**

- This button controls the width of the rollers.
- Select a massage function and press to adjust among Narrow, Normal and Wide widths.
- It can be used in Tapping, Shiatsu and Rolling massage modes.

Note

● Foot Roller

- Press once, to activate the roller massage. Press again, to stop the roller massage.

● Heating

- Touch this icon to turn off the heating from the rollers. Touch again to turn it on.
- In auto massage mode, the heating will set to default.

● 3D Mechanism

- There are 6 adjustable levels for the 4D mechanism intensity.
- In auto massage mode, the mechanism intensity will set to default.

● Adjust

- Intensity/ Strength/ Speed: There are 5 different levels for adjustment.

● 3D+ Sonic Massage

- Press once, to activate high frequency tapping. Press again, to stop tapping.

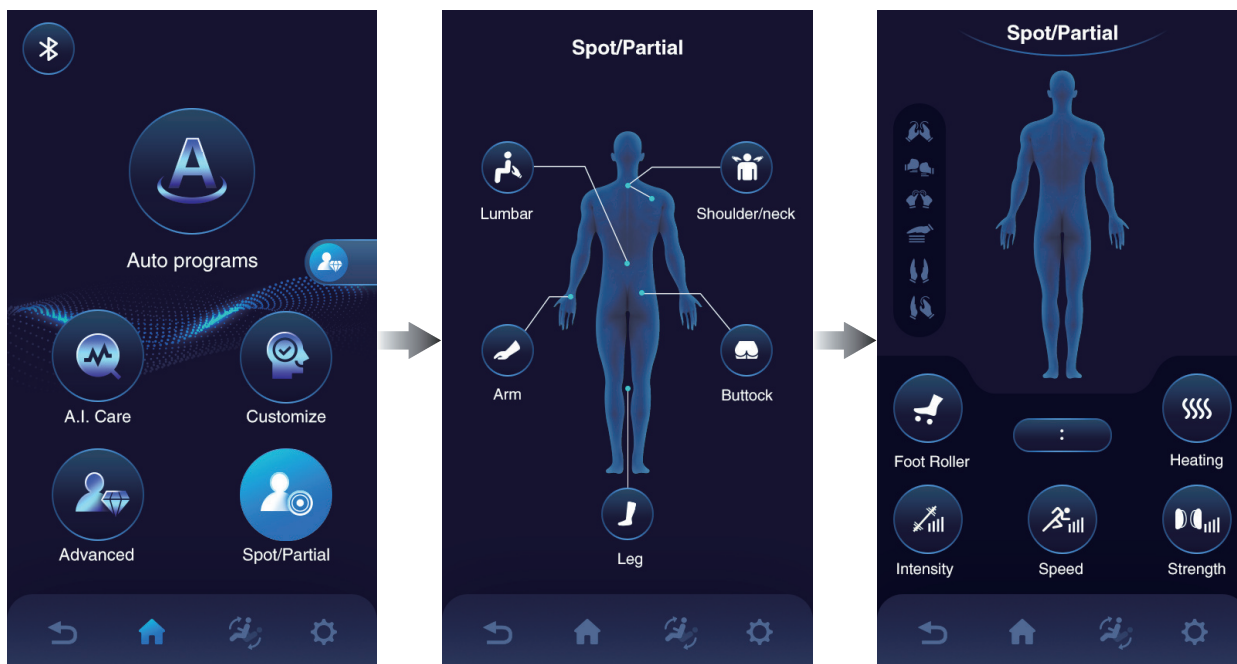

● **Spot/Partial**

- Touch Spot/Partial, then you can choose exclusive massage program for Lumbar/Shoulder-Neck/Arm/Buttock/Leg.

Note

- **Intensity/ Strength/ Speed**
- There are 5 different levels for adjustment.

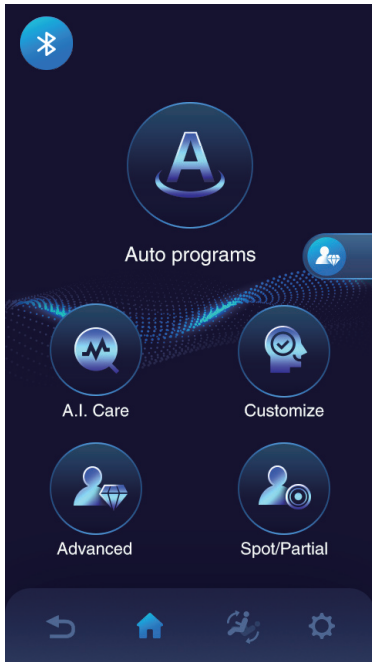





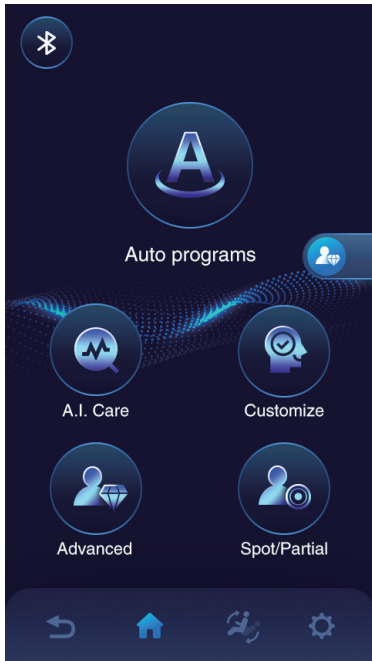



- **Bluetooth**

- Bluetooth name:OP-Vera 3D Plus.
- Press once to open Bluetooth,press again to close Bluetooth.



-  It's shortcut key of under way massage program.Touch it,then you can get in straightway.



- Users can adjust the reclination of the backrest and the footrest by long press the  . When you think that is the position you want, then stop press the icon again to stop the adjustment.
- The icon   allows you to extend or retract the length of the legrest.
- The two icon   control the recline/incline angle of the product.
- Touch the icon  to adjust the chair's zero-gravity position. Press the button again to return to the original position.
- Touch the icon  to control the light under the side panels.
- Touch the icon  to return the chair to its original position.

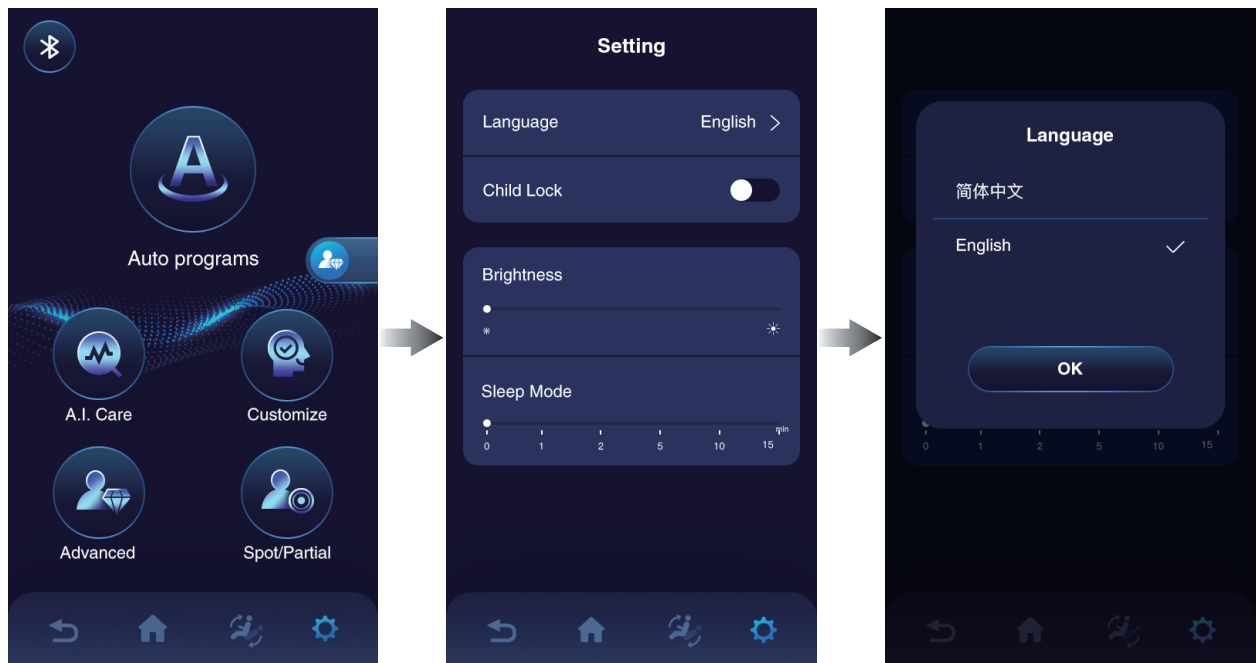

- Touch the icon , the screen will change to the Setting menu.
- Users can select language, Child Lock, Brightness, Sleep Mode in this page.

After massage

- 1 Turn off the power switch on the controller.
- 2 Pull the power switch to "O" position.
- 3 Pull out the power plug.



Warning

- After using, it is recommended to put the power switch to the OFF position and pull out the power plug;
Otherwise accidents and injuries by playing with them by children may happen.

Cleaning and maintenance

Cleaning of the synthetic leather

Wipe the synthetic leather with a soft dry cloth.

- **Do not clean the product with solutions containing chemicals such as thinners, gasoline and alcohol.**
- **Be sure that leather cleaner will not harm the synthetic leather by reading the label.**
- **If the synthetic leather is very dirty, wipe it with the method below.**

- ① Wet a soft cloth into water or 3% to 5% neutral detergent containing hot water and wring it out.
- ② Be sure the soft cloth is well wrung out till there is NO water dripping from the cloth.
- ③ Wipe surface of the synthetic leather with the soft cloth.
- ④ Be sure to rinse out the cloth multiple times when wiping down.
- ⑤ Have the synthetic leather dry naturally. Do not use dryer.

- **If it is difficult to remove the stains on the synthetic leather, try soak a piece of melamine foam into a neutral detergent to wipe down several times.**
- **Do not dry the surface by a hair dryer.**
- **Surface of the synthetic leather may fade or discolor if an inappropriate detergent is used. Test the cleaning solution in small section prior to fully applying.**
- **Do not clean the hard plastic parts with any alcohol, thinner or benzene based agents. This may cause discoloring or removal of the color all together.**



Cleaning of the plastic parts

1 Put a piece of soft cloth into water mixed with a neutral detergent contained hot water, wring it out and wipe the plastic parts.

- Do not clean the product with chemicals such as thinners, gasoline and alcohol.

2 Wipe down with a microfiber or soft cloth wrung out in clean water.

- Be sure the cloth is well wrung out with no water dripping, leaving the cloth damp.

3 Have the plastic parts dry naturally.



Questions and answers (Q&A)

Q Can someone with a medical condition or disease use this product?

A They must consult with their physicians before using the product.

Massage can aggravate or worsen muscle injuries, bone disease, spinal abnormalities, skin disease and kill ones with medical devices implanted in their body.

Q Is there a restriction body height and weight to use this chair?

A The recommended min. height is 4'9" with a max. height of 6'4". The max. weight capacity is 260 lbs.

If the user is shorter or taller than the height range, They will not fit comfortably in the chair and may even cause injury. The maximum weight limit must be followed to avoid damaging the chair and also possibly seriously injuring yourself while using the device. The limits are in place for the users safety.

For a taller person with knee bending when using the product:

Tilt the backrest and lower the Lower Leg/Foot massager to the down position, elongating the length from top to bottom.

For a short person difficult to touch the foot massage section:

Raise the backrest and raise the legrest to shorten the distance from the top to bottom.

Q Where is serial number of the product?

A It is located at behind the backrest at the back of the chair by the power cord.



Q When I use the chair it makes noise .

A It is part of the normal function of the chair.

The chair is equipped with an air pump and multiple motors. The sounds are part of chair when being operated.

Q How long should I use the massage chair each day?

A 20 minutes per day with no medical conditions.

For the 1st week of using the chair, use only for 20 minutes at most assuming the user is in good medical condition. If there is any discomfort stop using and consult with your doctor. The first few days of using you may experience mild soreness. Be sure to monitor the pain levels and if the soreness does no diminish after the following day consult with your doctor before using again.

BE SURE TO DRINK PLENTY OF WATER AFTER EACH MASSAGE.

Troubleshooting

If an issue occurs, inspect and trouble shoot according to the corresponding method below.

If the problem is not solved, contact the manufacturer for further instructions or service.

Fault	Cause and elimination method
<p>The massage wheels stop during use (The product beeps and all icons and buttons on the remote controller flicker and then go out.)</p>	<p>As a safety protocol the massage heads will stop if pressure/weight load has exceeded its limit.</p> <p>To avoid potentially over heating or damaging the massage mechanism the chair is designed to automatically shut off if over strained or over heated. The remote will flash a few times and then shut off as a safety measure. If this has occurred turn off the power switch from the back, allow for 30 sec. And power back on. If the weight capacity of 260 lbs is not exceeded, unplug from the outlet and notify the manufacturer.</p>
<p>The product cannot tilt, or the footrest cannot be raised or lowered (The product beeps, the running light on the remote controller go out and the product stops)</p>	<p>This product will stop upon any obstruction or a too large of a force preventing from operating.</p> <p>If all screen and buttons are flickering and the backrest or the footrest has stopped, turn off the power supply and turn back on 10 seconds. Be sure there are no obstructions in the way of the footrest or the backrest rolling mechanism.</p>
<p>The massage wheels cannot reach the shoulders or the neck</p>	<p>If your head is not properly placed against the backrest during the computer body scan, it may result in an incorrect reading, causing the rollers to start a lower position causing the massage to be inaccurate. If this occurs turn off the power from the remote and start over again to get a proper reading.</p>
<p>The left and right massage wheels have different heights (Intensities)</p>	<p>This is a normal function of the massage mechanism as it programmed to massage alternating locations from the right side during certain intervals of the program.</p>
<p>The chair is not functioning (massaging).</p> <ul style="list-style-type: none"> ● Upper body (the neck to the waist) massage ● Lower leg/foot massage 	<ul style="list-style-type: none"> ● The power line is disconnected. ● The power switch is not turned on. ● If no program is selected after turning, the chair will pause and shut down. Turn off and restart.
<p>The roller heads are still warm after turning off the heat. Or the product is damaged.</p>	<ul style="list-style-type: none"> ● Because the roller heads heat up it will take some time for the residual heat to dissipate. ● If the massage heads are mildly warm, the rollers may be admitting heat created by the friction from the massage.
<p>The power line or the power plug is abnormally warm to hot.</p>	<p>To avoid accidents, contact an authorized service center.</p>

If above solutions are not applicable, kindly refer to “Product Warranty Card” and contact service center.

Troubleshooting (Continued)

Expected sounds and feelings when using the massage chair.

You will hear or have the following feelings when using the product. These are not defective indicators but a normal function of the chair.

- When chair extends or retracts you will hear gears moving and clicking.
- A rubbing sound will be mildly heard when the massage heads are activated.
- When the massage heads are tapping you may hear a mild clicking sound.
- Friction sounds will be experienced as the rollers are activated.
- As the rollers move up and down the motor produce a sound.
- As the rollers are activated you will hear spinning of belts rotating.
- Motor sounds will be experienced.
- As the massage heads are squeezing, a mild squeaking sound will be heard.
- When sitting in the chair as the roller heads are tapping and rolling a mild squeaking sound may be produced from the joints.
- Common joints that may squeak would be from the side panels
- Friction sound between the massage wheels and the fabric.
- Motors will be heard from the pump when the airbags deflate.
- While the airbags are activated you will hear air valves alternating.
- When the legrest is moving, you will hear mild squeak and a motor operating.



If the sound is loud, it is also possible that the product has failed.

- In this case, have the product inspected and repaired by an authorized service center.

Warning

- **Do not refit, disassemble or repair the product without permission.** Otherwise fires, abnormal movements or personal injuries may happen.

Warning

- **In the case of any abnormality or fault, stop the product immediately and pull out the power plug to avoid fuming, fires and electric shocks.**

<Abnormality and fault example>

- The product fails to work after the power switch is turned to the ON position;
 - When the power cable is moved the chair will turn off and on.
 - In use, the product gives off a burning smell or an abnormal sound;
- The product upholstery is deformed or abnormally hot.

If any of these symptoms occur, have the product inspected and repaired by an authorized service center immediately.

Specifications

Description	Specifications
Model No.	OP-Vera 3D Plus
Rated Voltage	110-120V~
Rated Frequency	60Hz
Rated current	0.8A
Timer	5/10/15/25/30 minutes
Dimension (L x W x H)	Product carton: 53.9" x 29" x 38.4"
	Side panel carton: 25.8" x 15.7" x 39.4"
Weight	Product gross weight: 266.8 lbs
	Product net weight: 231.5 lbs
Length of the wire	Controller wire: 59"
	Power supply wire: 71"
	Audio wire: 25.6"
Usage condition	Environment temperature: 10°-40°
	Contrasting humidity: 30-85RH
Storage condition	Storage temperature: 20°-60°
	Storage humidity level: 30-85RH
Safety feature	Equipped with overheated and power surge safety protection.
Using benefits	Increasing blood circulation; Relieving muscular fatigue



FCC Radiation Exposure Statement

FCC Radiation Exposure Statement: (mobile device)

This equipment complies with FCC radiation exposure limits set forth for an uncontrolled environment. In order to avoid the possibility of exceeding the FCC radio frequency exposure limits, Human proximity to the antenna shall not be less than 20cm (8 inches) during normal operation.

FCC STATEMENT

1. This device complies with Part 15 of the FCC Rules. Operation is subject to the following two conditions:
 - (1) This device may not cause harmful interference, and
 - (2) This device must accept any interference received, including interference that may cause undesired operation.
2. Changes or modifications not expressly approved by the party responsible for compliance could void the user's authority to operate the equipment.

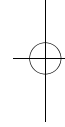
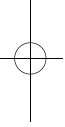

This equipment has been tested and found to comply with the limits for a Class B digital device, pursuant to part 15 of the FCC Rules. These limits are designed to provide reasonable protection against harmful interference in a residential installation. This equipment generates, uses and can radiate radio frequency energy and, if not installed and used in accordance with the instructions, may cause harmful interference to radio communications. However, there is no guarantee that interference will not occur in a particular installation. If this equipment does cause harmful interference to radio or television reception, which can be determined by turning the equipment off and on, the user is encouraged to try to correct the interference by one or more of the following measures:

- Reorient or relocate the receiving antenna.
- Increase the separation between the equipment and receiver.
- Connect the equipment into an outlet on a circuit different from that to which the receiver is connected.
- Consult the dealer or an experienced radio/ TV technician for help.



Industry Canada Notice

Industry Canada Notice

This device complies with Industry Canada licence-exempt RSS standard(s).

1. Operation is subject to the following two conditions:

- (1) this device may not cause interference, and
- (2) this device must accept any interference, including interference that may cause undesired operation of the device.

2. Changes or modifications not expressly approved by the party responsible for compliance could void the user's authority to operate the equipment.

Avis d'Industrie Canada

Le présent appareil est conforme aux CNR d'Industrie Canada applicables aux appareils radio exempts de licence.

1. L'exploitation est autorisée aux deux conditions suivantes :

- (1) l'appareil ne doit pas produire de brouillage, et
- (2) l'utilisateur de l'appareil doit accepter tout brouillage radioélectrique subi, même si le brouillage est susceptible d'en compromettre le fonctionnement.

2. Cet appareil numérique ne dépasse pas les Rèlements sur l'interférence radio par un appareil numérique de classe B stipulées dans les Règlement sur l'interférence radio d'industrie Canada.



EN34

