

*Osaki*

Instruction Manual

4D Orion Duo Mech





# Contents

Important Safety Instructions .....	2
Product Parts .....	8
Things To Know And Do Before Use .....	9
How To Use The Remote .....	13
Operation Guide .....	16
Voice Control .....	29
After Massage .....	30
Cleaning And Maintenance .....	31
FAQ .....	32
Troubleshooting .....	33
Specification .....	35
FCC Radiation Exposure Statement .....	36
Industry Canada Notice .....	37



# Important Safety Instructions Must be followed



These safety instructions must be strictly followed in use to avoid personal injuries and property damage :

■ All the safety instructions are described in compliance with degrees of the injuries or damage as a result of wrong use.

 <b>Warning</b>	Actions leading to cause serious injuries or death
 <b>Caution</b>	Actions leading to cause minor injuries or property damage

■ Pay attention to the symbols before safety instructions (an example is given below).



 Actions that must be absolutely forbidden	 Actions that must be done
---	---

 <b>Warning</b>	
 <b>Must be followed</b>	<ul style="list-style-type: none"> <li>● <b>IMPORTANT SAFETY INSTRUCTIONS</b> When using this product, basic precautions should always be followed, including the following: Read all instructions before using (this product).</li> <li>● <b>DANGER-To reduce the risk of electric shock:</b> <ul style="list-style-type: none"> <li>• Always unplug this product from the electrical outlet after using and before cleaning.</li> <li>• Never use unauthorized parts or hardware for this chair. No modifications are allowed.</li> <li>• Carefully examine the covering before each use. Carefully examine the upholstery from top to bottom. If there are any signs of cracking, blistering, rethreading or tearing, stop using the product and contact the manufacturer for a replacement or further instructions. Please unplug the chair from the power outlet.</li> <li>• This product must be kept a climate-controlled area. 60-85 degrees Fahrenheit with very low moisture at ALL times.</li> </ul> </li> <li>● <b>WARNING-To reduce the risks of burns, fire, electric shock or injury to persons:</b> <ul style="list-style-type: none"> <li>• An appliance should never be left unattended when plugged in. Unplug from outlet when not in use and before any authorized installs or alterations are being made.</li> <li>• Close supervision is required if you have any pets, children in the area when chair is being used.</li> <li>• Use this product only for its intended use as described in this manual. Do not use attachments not recommended by the manufacturer.</li> <li>• Never operate this product if it has a damaged cord or plug, if it is not working properly, if it has been dropped, damaged or dropped into water. Contact the manufacturer for examination and repair.</li> <li>• Never pull on any cables wire on this product.</li> <li>• Keep the cord away from heat source like a vent or a humid area like a bathroom.</li> <li>• If any the of the air hoses are plugged stop using the chair and contact the manufacturer and unplug power from the outlet.</li> <li>• Never allow for any object to fall into the chair or cracks of the chair.</li> <li>• This product is for indoor use only in a dry climate controlled area.</li> <li>• Do not operate where aerosol (spray) products are being used or where oxygen is being administered.</li> <li>• To disconnect, turn all controls to the off position then remove plug from outlet.</li> <li>• Keep children away from this product as working parts can seriously injure a child or pet.</li> <li>• Connect this appliance to a properly grounded outlet only. See Grounding Instructions.</li> <li>• Carefully Monitor the heating areas of the chair. If there is any abnormality or discomfort, turn off the chair, unplug the power from the outlet and contact the manufacturer.</li> <li>• Do not operate this product using a blanket or pillow. Excessive heating can occur and causing fire, electric shock or injury to persons.</li> <li>• Any elderly, handicap person, children (under 18) or with any person with a medical must consult with a medical doctor if this product can be used.</li> </ul> </li> </ul> <p style="margin-top: 10px;"><b>SAVE THESE INSTRUCTIONS</b></p> <ul style="list-style-type: none"> <li>● <b>Any person with an implanted medical device or medical condition or under any treatment must get approval from your medical doctor before using this device.</b></li> </ul>

## ⚠ Warning

	<p>(1) Any person with a pacemaker cannot use this product. The chair may cause an electronic malfunction to the medical device;</p> <p>(2) Patients with malignant tumors;</p> <p>(3) Patients with heart disease;</p> <p>(4) Person unable to feel or insensitive to heat on their skin such as a diabetic patient;</p> <p>(5) Pregnant women or ones that have just given birth;</p> <p>(6) Persons with poor blood circulation such as a diabetic patient;</p> <p>(7) Osteoporosis patients, spinal fracture patients or persons with acute painful disease or injuries such as joint sprains or muscle strains;</p> <p>(8) Persons with any injuries should not use this product.</p> <p>(9) Persons with higher or lower regular body temperature, fever, inflammation, cold symptoms, high blood pressure or any poor health conditions should consult a physician before using this product;</p> <p>(10) Avoid falling asleep in this chair;</p> <p>(11) Any one with spinal or nerve conditions;</p> <p>(12) Persons with protrusion of intervertebral disc;</p> <p>(13) Do not wear loose clothing or jewelry as it might get caught with massage mechanism;</p> <p>(14) Keep long hair away from moving massage mechanism while in use.</p> <p>Otherwise discomfort or even physical injuries may occur.</p>
<p style="text-align: center;"><b>!</b> Must be followed</p>	<p>● If you feel unwell while using or after using the chair, stop immediately and contact your physician. Do not use the chair again unless approved by your doctor.</p>
	<p>● Before operating or adjusting the chair, be sure that there are no obstructions that can cause damage to your chair. No pets or persons, near, in front or under the chair to avoid serious injury.</p>
	<p>● Before using the chair, look behind the backrest pad and inspect the area where the massage rollers travel up and down for any tearing or abnormal wear. Be sure the middle nylon cover is not unzipped and has no signs of damage or tear caused by the roller heads. Using the chair while the roller heads are exposed could cause physical injury, electrical shock or breakage.</p>
	<p>● When using the chair for the first time, it is recommended that you select the “Demo” mode to get familiar with various massage features of the chair.</p> <p>● Do not use the chair for more than 30 minutes each time.</p> <p>● Do not massage a single part of your body for more than 5 minutes.</p> <p>Failing to follow these instructions, discomfort or even physical injuries may occur.</p>
	<p>● After using the chair, it is recommended that the chair is unplugged from the power outlet to avoid any surges caused by outages. It is <b>HIGHLY ADVISABLE TO ALWAYS USE A SURGE PROTECTOR</b>. Keep children or minors from using the chair without supervision to avoid misuse that could result in serious injuries.</p>
	<p>● Follow the local code and regulations about use of electrical products.</p> <p>● Use a 110V-120V, 60Hz power supply. (Do not use the chair in a country this product is not designed for or connect it with a transformer.) It may lead to electrical shock, product failure or internal components overheating causing fire hazard.</p>
	<p>● Make sure the power cable is firmly plugged into the outlet to avoid power surges, short and electrical shocks. Electrical shocks may cause internal component overheating causing fire hazard.</p> <p>● Wipe and clean the power plug regularly with dry cloth to avoid dirt or moisture built up.</p>
<p style="text-align: center;"><b>!</b> Must be followed</p>	<p>● In the case of any abnormality with functions of the chair, stop using the chair immediately and pull out the power plug to avoid smoke, fires and electric shocks. Abnormality and fault examples are:</p> <p>● If the chair is plugged in and the power switch is in the “ON” position and if the chair is not responding.</p> <p>● When the chair is turned off but still operating.</p> <p>● If you detect any burning smell or abnormal sounds.</p> <p>● If you detect any parts of the upholstery that seemed to have melted due to over heating.</p> <p>—In any of these listed issues have occurred STOP using the product and unplug from the power outlet. Have the product inspected by an authorized service center.</p>
<p style="text-align: center;"><b>⊘</b> Forbidden</p>	<p>● Do not put any cushions or obstructions between the backrest pad and the backrest. This may damage the mechanism and result in personal injury.</p> <p>● When moving or handling the chair, be sure to hold onto the recommended supported area. Otherwise parts of the chair may break resulting in serious injury.</p>

## **Warning**





 <b>Forbidden</b>	<ul style="list-style-type: none"> <li>● People with the following health issues should <b>NOT</b> use this chair: Persons for whom massage is not advisable by doctors. Such as persons with thrombosis, serious aneurysm, acute venous aneurysm, various skin inflammations (such as subcutaneous tissue inflammation) or various skin infections. Otherwise it may aggravate or cause serious injury.</li> </ul>
	<ul style="list-style-type: none"> <li>● Anyone with physical injuries or poor health should <b>NOT</b> use this product. Persons with acute lumbago, protrusion of intervertebral disc or displacement of a lumbar vertebra. Otherwise it may aggravate or cause serious injury.</li> </ul>
	<ul style="list-style-type: none"> <li>● Do not put hands, arms or feet into the traveling massage mechanism while the chair is operating.</li> <li>● Keep small children away from the chair. Climbing could result in falls that could lead to serious injuries.</li> <li>● Do not climb onto the backrest or the armrests.</li> <li>● Do not apply excessive pressure leaning back on the backrest.</li> <li>● Keep your head away from reachable areas of the backrest and the back cover.</li> <li>● Young persons or persons with physical disabilities that can not operate the chair on their own, should not use this product or without supervision. Anyone with weakened physical conditions should consult a doctor before using the chair.</li> <li>● When massaging the neck area, pay attention to the intensity of the massage and make sure it does not hurt the neck muscles or nerves.</li> </ul>
	<ul style="list-style-type: none"> <li>● Do not damage the power cord. Do not damage, alter, bend, twist or use it with any extension cords. Do not place the power cord close to a heater. A damaged power cord may result in electric shocks, short circuit or fires. Please consult with the retailer/dealer from which you bought the product or a designated authorized service center about maintaining your power cord.</li> </ul>
	<ul style="list-style-type: none"> <li>● When engaging the heat function of massage wheels, avoid prolong contact with the skin in one position. Otherwise low-heat burns may occur. Even if the temperature is relatively lower at 104°F~140°F, low-heat burns may happen in spite of no obvious hot or painful sensation.</li> </ul>
 <b>Wet-hand operation forbidden</b>	<ul style="list-style-type: none"> <li>● Do not insert or pull out the power plug when your hands are wet. Otherwise electric shocks may happen.</li> </ul>
 <b>Disassembly forbidden</b>	<ul style="list-style-type: none"> <li>● Do not refit, disassemble or repair the product without the help of an authorized service provider. Otherwise fires, abnormal movements or personal injuries may happen.</li> </ul>

## **Caution**

-  **Must be followed**
- The following persons (even if they are physically healthy at present) should consult a physician before using the product.
    - (1) Persons with muscular atrophy;
    - (2) Persons with any spinal or back pain or spinal condition;
    - (3) Persons suffer from sprains or bruising easily;
    - (4) Persons with motion sickness;
    - (5) Persons who received a heart operation or another vascular operation.It may cause serious injury if not addressed properly. Otherwise, it may cause serious injury.
  - Before sitting on the product, make sure there is no foreign objects obstructing any part of the chair.  
(Make sure there are no foreign objects on the back cover, the backrest, the seat surface, the lower leg/foot massage section or inside surface of the back cushion.)  
Otherwise, accidents or injuries from product failure may cause serious injury.  
Before sitting on the seat, make sure the massage wheels are in the retracted positions.
  - Turn off the massage function before you get off the chair.
  - When the lower leg/foot massage section is not retracting after the massage, retract the footrest with the remote button.
  - When unplugging the chair, hold onto the head of the to plug and not the cord to avoid damaging to the power cord. Damaged cord could result in shock and serious injuries.
  - Before moving the chair, be sure the backrest is in the upright position and the footrest is retracted in default positions.  
Otherwise, injuries may happen or damage to the chair.
  - When moving the product by dolly, lay mats on the floor to avoid markings or damage to the floor. Do not roll the chair on engineered wood or soft wood floorings. Otherwise marks and damage may occur.
  - Keep the safety lock key.  
Keep children away the remote control.
  - Before moving the chair, make sure there are no obstructions around. If lifting is required, make sure to lift from the steel frame of the chair. Be sure to keep the chair in the upright position when lifting the chair when moving.
  - Symptoms such as skin inflammation, itching or swelling when using the chair, stop the using the product immediately and consult a physician.

-  **Forbidden**
- Do not use the product with other electrical devices at the same time, such as a heating blanket.
  - Do not place your hands, arms, feet or any parts of your body to massage area that are not designed for the body parts to avoid discomfort or injuries.
  - Do not put the knees between the calf massager. This may cause serious injury.
  - Do not fall asleep while using the product.
  - Do not use the product after drinking alcohol.
  - If the airbag on the seat is not completely deflated, do NOT attempt to deflate the air bag by force or using any tools. Contact the manufacturer to resolve the matter.

## **Caution**

 <b>Forbidden</b>	<ul style="list-style-type: none"> <li>● Do not put hands or feet between footrest and seat base.</li> <li>● Do not put hands or feet between footrest and side panel.</li> <li>● Do not put hands or feet between seat base and side panel.</li> <li>● Do not put hands or feet between the upper and the lower part of the footrest.</li> <li>● Do not put hands or feet in the gap of seat base.</li> <li>● Do not put pets on the massage chair.</li> <li>● Do not pull out the power plug or turn off the power switch suddenly during massage operation.</li> </ul>
	<ul style="list-style-type: none"> <li>● Do not stand or sit on the backrest. This may lead to serious injury and damage to the product.</li> </ul>
	<ul style="list-style-type: none"> <li>● Do not stand or sit on the armrests.</li> </ul>
	<ul style="list-style-type: none"> <li>● Do not stand or sit on the lower leg/foot massage section or the footrest.</li> </ul>
	<ul style="list-style-type: none"> <li>● Do not drag or push the product after it is installed.</li> </ul>
	<ul style="list-style-type: none"> <li>● Do not move the product while there is a person sitting on it.</li> </ul>
	<ul style="list-style-type: none"> <li>● Do not use the product with other heating devices such as electric blankets. Otherwise fires may occur due to overheating.</li> </ul>
	<ul style="list-style-type: none"> <li>● Do not leave the remote controller on the seat, always return it to its holder.</li> </ul>
 <b>Wet-hand contact forbidden</b>	<ul style="list-style-type: none"> <li>● Do not place this chair in locations with high humidity such as the bathroom. Moisture will destroy electrical components resulting in product failure or worst, electrical shock and other serious injuries.</li> </ul>
 <b>Product wetting forbidden</b>	<ul style="list-style-type: none"> <li>● Do not use any liquid aerosol sprays around the chair. Otherwise, electric shocks, fire, short circuit or product failure may happen.</li> </ul>
 <b>Pull out the power plug</b>	<ul style="list-style-type: none"> <li>● Before cleaning or maintaining the product, always unplug the power cord.</li> </ul>
	<ul style="list-style-type: none"> <li>● In the case of a power failure, pull out the power plug at once. It is highly recommended to plug chair into a surge protector to protect the chair from shorting during outages.</li> </ul>
	<ul style="list-style-type: none"> <li>● When the product is not in used, pull out the power plug.</li> </ul>

## GROUNDING INSTRUCTIONS

This product must be grounded. If it should malfunction or break down, grounding provides a path of least resistance for the electric current to reduce the risk of electric shock. This product is equipped with a cord with an equipment-grounding conductor and a grounding plug. The plug must be plugged into an appropriate outlet that is properly installed and grounded in accordance with all local codes and ordinances. **Danger-Improper connection of the equipment-grounding conductor can result in a risk of electric shock. Check with a qualified electrician or serviceman if you are in doubt as to whether the product is properly grounded. Do not modify the plug provided with the product – if it will not fit the outlet, have a proper outlet installed by a qualified electrician.**

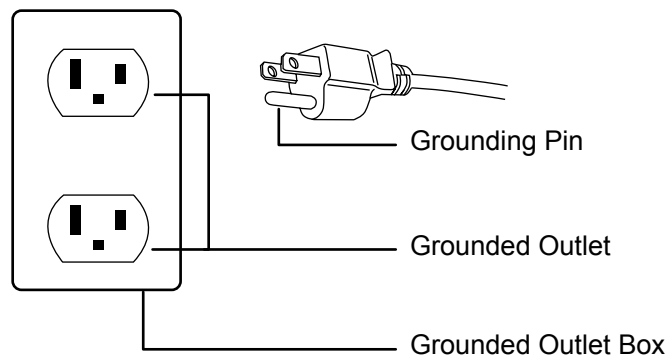

# Product Parts



## Before Use

### 1 Installation position

- Make sure there is enough space to recline the chair and for the user to get in and out of the chair freely. PLEASE MAKE SURE TO USE A MAT OR RUG UNDER CHAIR IF YOU PLACE THE CHAIR ON TOP OF A HARD SURFACE LIKE HARWOOD AND CERAMIC FLOORS.

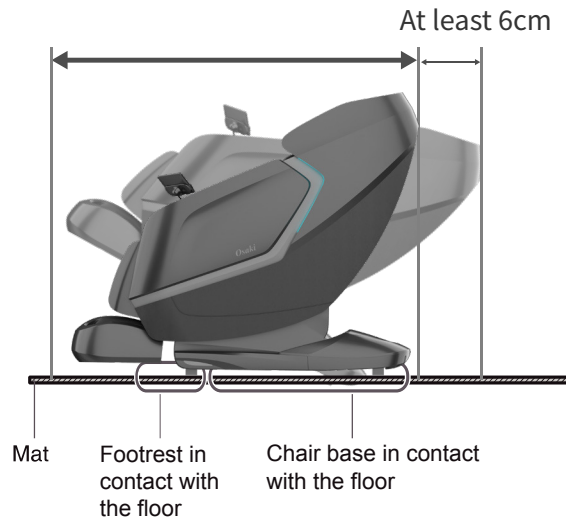

- Do not expose the product directly under the sunlight or in a high-temperature place (e.g., in front of heating equipment or by a window where sunlight can cause the synthetic leather fade, melt or crack.)
- Place a mat below the product to avoid floor damage. The mat should cover the product's area in contact with the floor and the footrest's area in contact with the floor (minimum dimensions: 63"x31.5"). See the figure.
- Install the product close to a power socket.

### 2 Inspect the Space Around the Chair.

Do not place or use the chair near individuals, animals, or any items that might interfere with the chair's functionality.



### 3 Ensure No Foreign Objects within the Seams of the Chair.

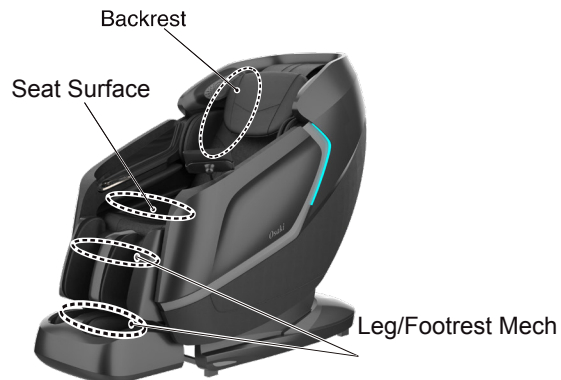

#### ⚠ Caution

- Do not put hands or feet between footrest and seat base.
- Do not put hands or feet between footrest and side panel.
- Do not put hands or feet between seat base and side panel.
- Do not put hands or feet between upper and lower part of the footrest.
- Do not put hands or feet in the gap of seat base.  
otherwise injuries may happen.

### 4 Examine the Power Cord & Electrical Plug

#### ⚠ Warning

- Inspect the power cord of dirt or dust that may have collected. Be sure the cord is kept clean and with NO visible damage.

Otherwise the lint and dust may lead to an electrical fire. Wipe down the plug with dry cloth.

- Do not damage the power line or the power plug.
- Do not bend or twist the power cord for any reasons.
- Do not place the power cable under heavy objects such as the chair itself. Keep the power cord away from any heating sources such as the heater vents, motors and anything that may generate heat.

A damaged power line or power plug may result in electric shocks, short circuits or fires.

Please consult the shop you bought the product or an authorized service center about maintenance method of the power line or the power plug.



Ensure the plug is fully inserted into the chair port, and keep the power cord untangled to prevent any potential damage.

## 5 Power on the Chair

- 1 Insert the power plug into the power outlet.
- 2 Turn the switch to the "I" (ON) position to activate the chair.

### Warning

- **Be sure the power cord is firmly and completely inserted into the power outlet.**  
Otherwise electrical shocks or fires may occur because of overheating or power shorts.
- **Abide by the regulations on use of the socket and the wiring devices strictly.**
- **Use a 110-120V~, 50/60Hz power supply.**  
(Do not use the product in a foreign country or connect it with a transformer without permission.)  
Otherwise electric shocks, product faults or fires because of overheat may happen.
- **Do not insert or pull out the power plug with wet hands.**  
Otherwise an electric shock may happen.

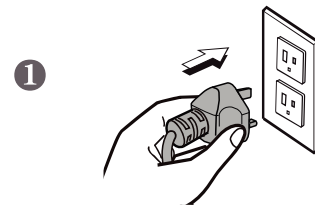

## 6 Ensure that the massage rollers are correctly positioned



If the rollers are not positioned correctly at the top of the backrest, press the "ON" button to reset them to the default position.

## 7 Ensure that the Fabric is Not Damaged or Cracked.

Examine the synthetic leather area where the massaging rollers move along the backrest, and make sure there is no damage or unusual wear.



### Warning

- Before use, raise the back cushion and check whether fabrics lining pointed out in the figure are undamaged. Even if the fabric is slightly damaged, stop using the product immediately. Pull out the power plug and send notify the manufacturer for a replacement cover. If the product is used when there is fabric damage, you may get injured or get an electric shock.

# The Quick Control Remote Instructions

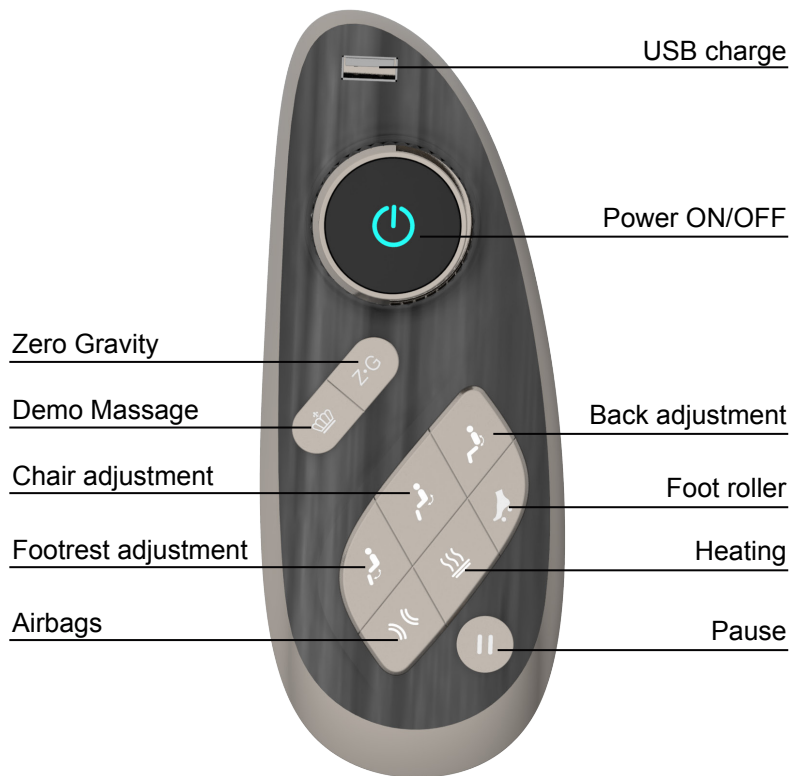



- **Power ON/OFF**

Long press to power on the chair, long press again to power off the chair.

- **Demo Massage**

Press the button, start auto massage, experience Demo Massage directly.

- **Zero Gravity**

There are 4 steps for Zero Gravity, one click enter to Zero Gravity 1, two clicks enter to Zero Gravity 2, three clicks enter to Zero Gravity 3, four clicks reset the chair.

- **Footrest adjustment**

Press the button, the footrest raise up, press again lower the footrest, long press the icon, put down the footrest.

- **Chair adjustment**

Press the button, the chair enter to zero gravity , press again raise up the chair, long press reset the chair.

- **Back adjustment**

Press the button, the back recline, press again raise up the back, long press reset the back.

- **Airbags**

Press the button, start the airbag massage.

- **Heating**

Press the button, open the waist and calf heating,press again to close the heating.

- **Foot roller**

Press the button, start foot roller, press again to stop.

- **Pause**

Press the button, pause massage, press again continue to massage.



# The Controller Instructions

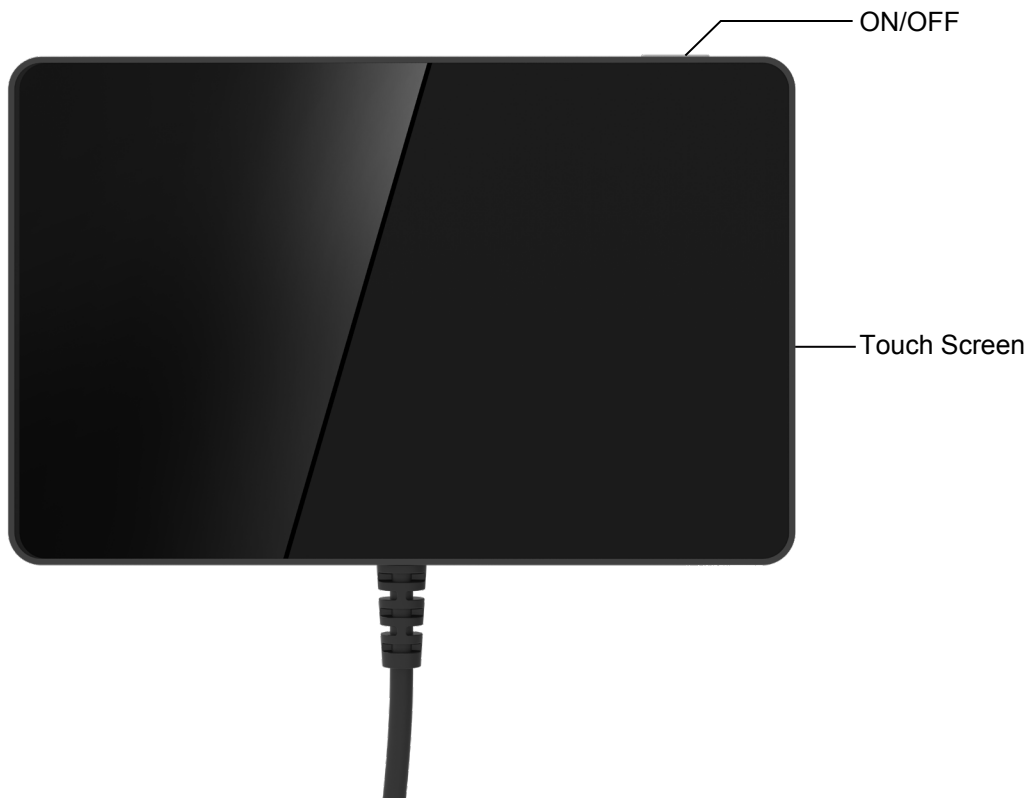

# Operation Guide

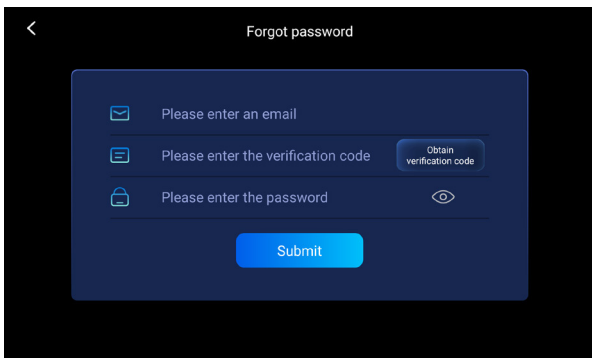
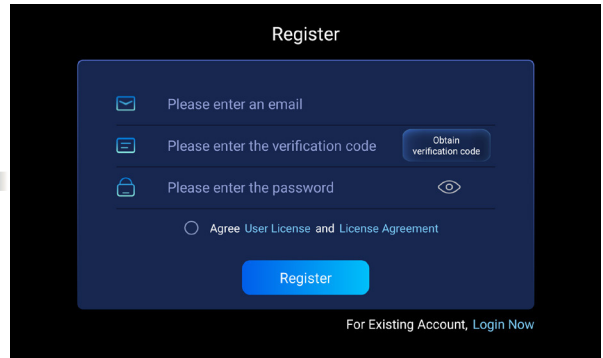
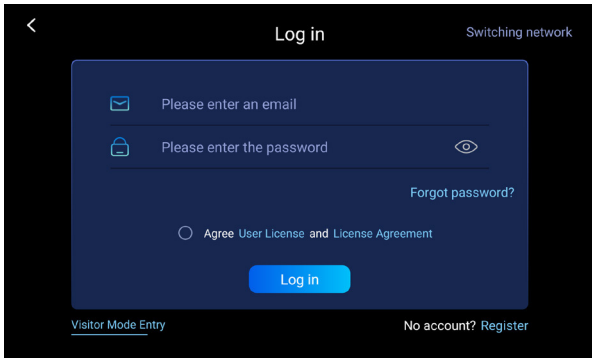
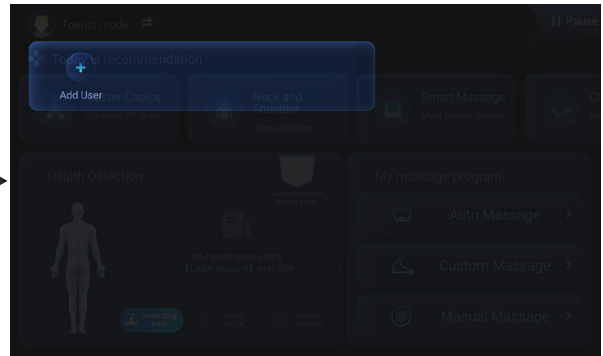
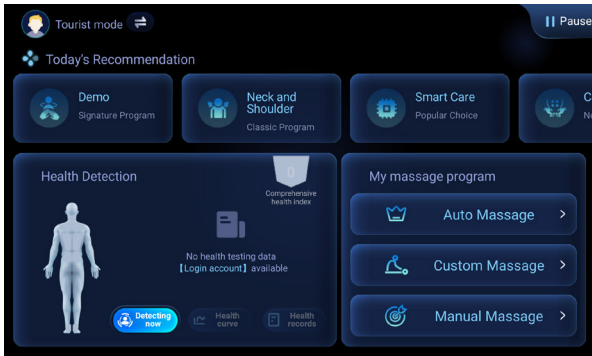

## How to become a user

- Touch  on the top left corner, come to page "Add User".
- Registration page please follow the required information to register, and then log in.
- If you have already registered, please enter your account/password directly to log in.
- If you forget your password, please touch "Forgot password?" to retrieve your password.

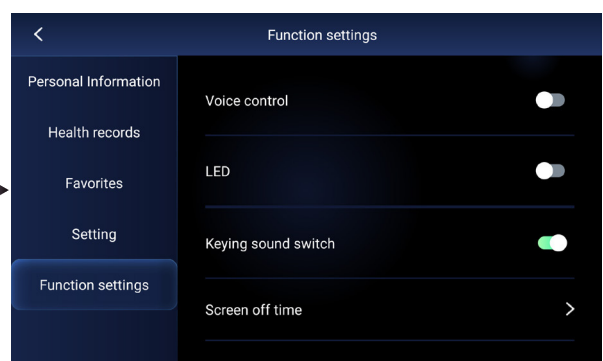
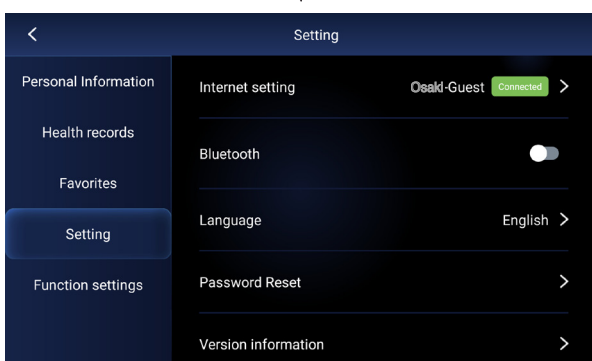
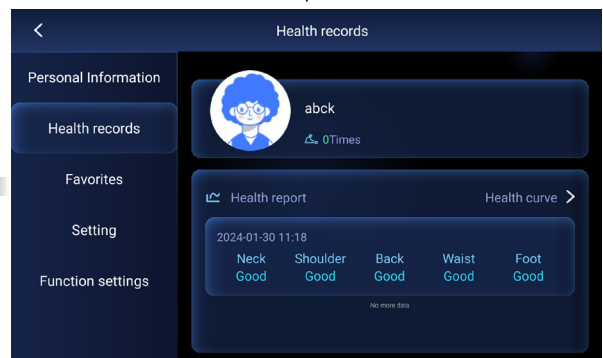
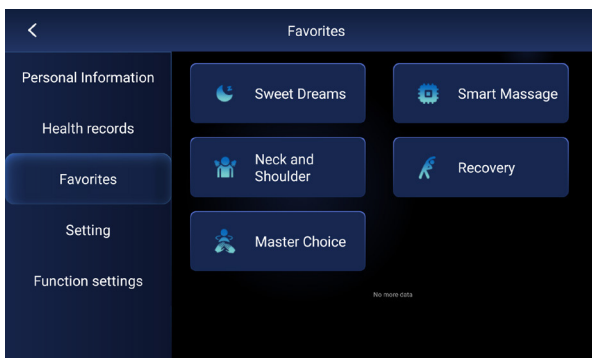
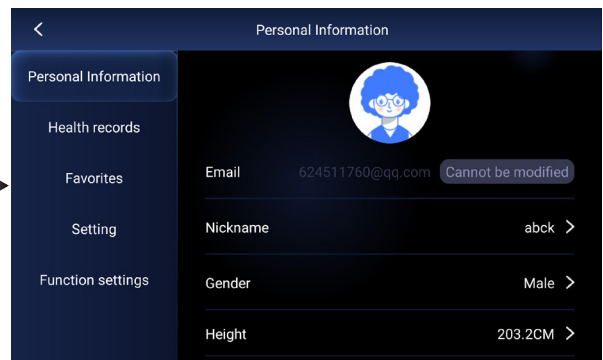
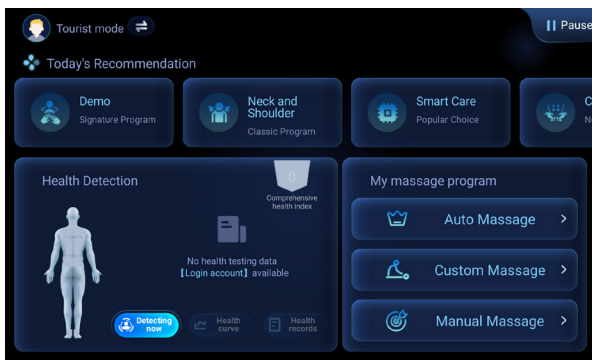

## User information and Settings

- Touch  on the top left corner, there will have Personal Information/Health records/ Favorites/ Setting/ Function Settings.

### Personal Information

- If you are a user, this page will have Email/Nickname/Gender/Height/Weight/Birthday information for edited and record.

### Health records

- If you are a user, every health report will be recorded here.

### Favorites

- If you are a user, Your favorite programs will be saved here, you can choose the favorite program at any time.

### Setting

- There will have Internet setting/Bluetooth/Language/Password Reset/Version setting information, it can be set according to your needs. User can reset password by "Password Reset".

### Function settings

- There will have Voice control/LED/Keying sound switch/Screen off time/Brightness/One Key Auto Test setting information, it can be set according to your needs.

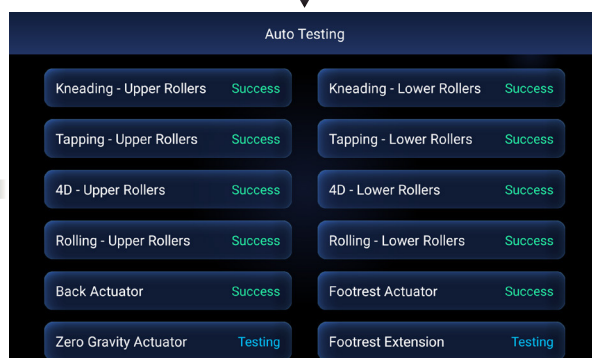
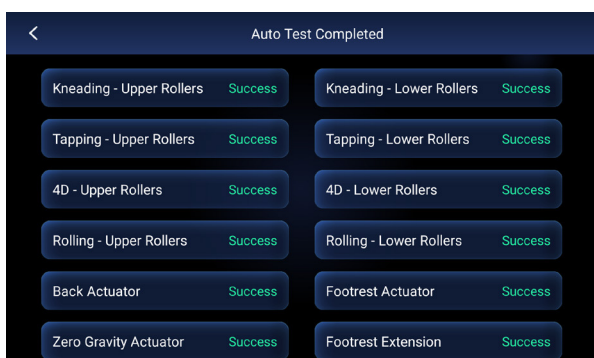
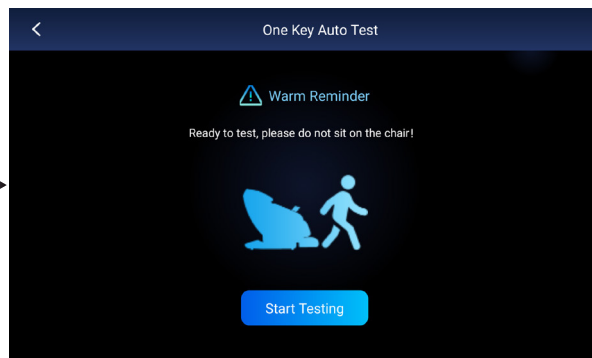
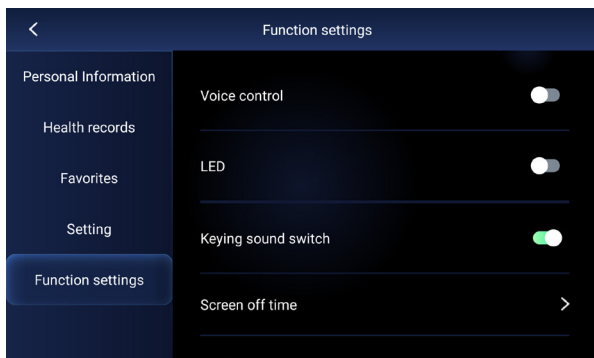









## One Key Auto Test

- This chair has "One Key Auto Test" function, before massage, touch this icon for chair testing, please make sure people get out of the chair during testing, and return after the testing is completed.



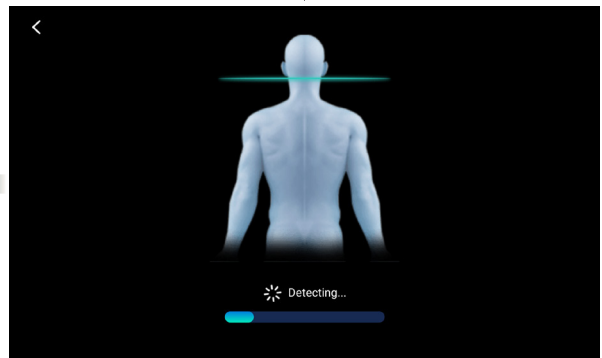
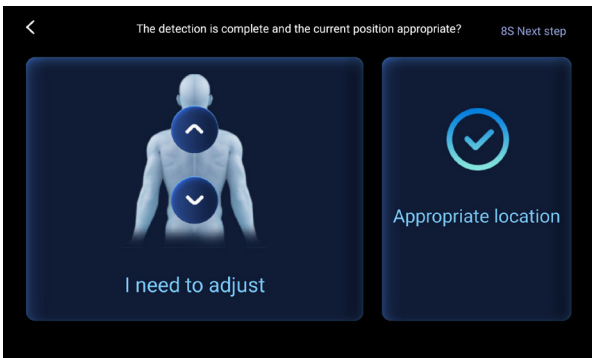
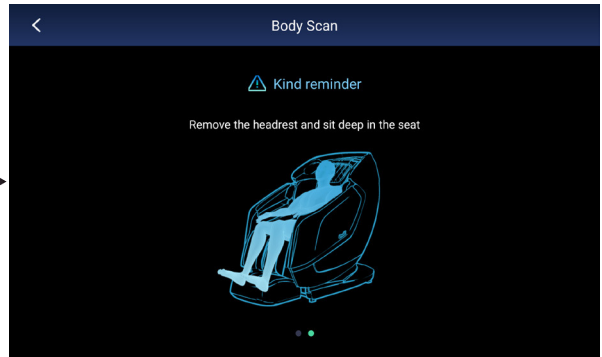
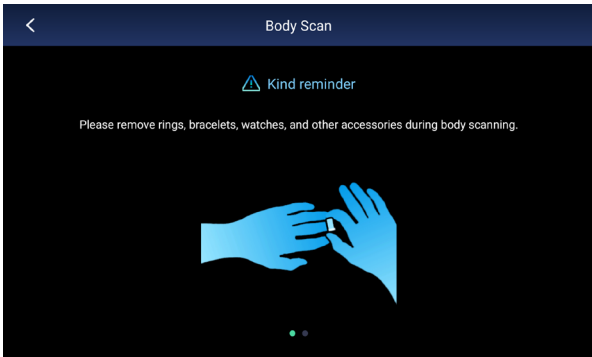

## Auto Massage Programs

- **Demo**  Focus on neck and shoulder/waist massage with kneading and rolling techniques.
- **Smart Care**  Take care of neck and shoulder/hip, Precision massage on key position.
- **Neck and Shoulder**  Targets the neck and shoulder, with the goal of alleviating neck and shoulder muscle.
- **Thai Stretch**  Deep full body stretch, activate the muscles and bones.
- **Body Circulation**  Appropriate strength with kneading and rapping techniques,full body massage, promote blood circulation.
- **Care**  Waist and hip care, a full body stretch massage in the middle, with kneading and rolling techniques.
- **Deep Tissue**  Intense kneading and thump to alleviate stress in the entire body.
- **Gentle**  Slow kneading and clapping massage that provides a comforting sensation to your entire body.
- **Relax**  Combines kneading and clapping techniques to focus on the entire body with deep massage.
- **Lumbar Care**  Focus on waist and hip massage with kneading and clapping.
- **Recover**  Kneading and rolling for shoulder and neck with deep intensity.
- **Calm**  Targets the muscles in whole body, using various techniques to loosen up in mind and body.
- **Energetic Morning**  Slow thump massage that provides a comforting sensation to your entire body.
- **Revitalize**  Focus on waist and hip massage, soft kneading and thump to reactivate.
- **Fatigue**  Particularly effective at relieving muscle pain and fatigue.
- **Sweet Dreams**  Gentle, soft kneading techniques to promote relaxation and aid in falling asleep.



## Body Scan Detection

- Before entering massage program, there will be a body scan detection function.
- Make sure all accessories removed and sit deep in the seat during body scanning.
- After detecting, if the position needs to be adjusted, pls touch   to adjust; Or touch  to next massage program.

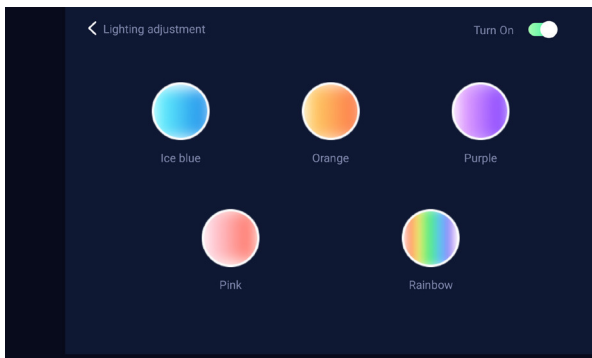
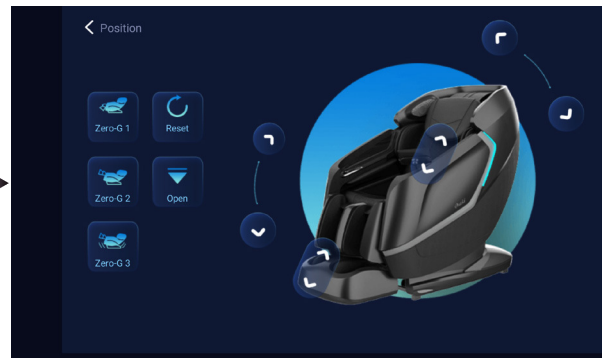
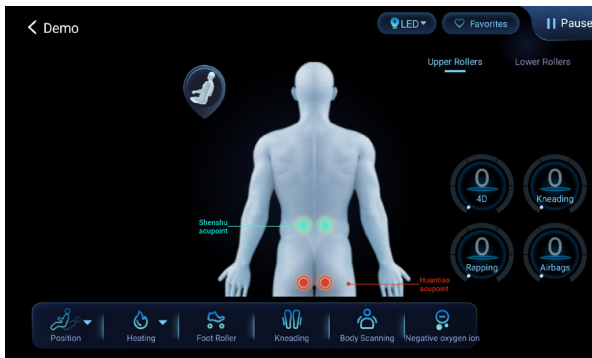

## Auto Massage

### ● Upper Rollers/Lower Rollers

Touch Upper Rollers to focus on upper massage, touch Down Rollers to focus on lower massage. You can adjust the strength/speed under 4D/Kneading/Rapping/Airbags.

### ● 4D/Kneading/Rapping/Airbags

There are 6 levels for adjustment for 4D mechanism ejection, 5 levels for adjustment for Kneading /Rapping/Airbags.



### ● Position



Touch this icon to adjust position.



There are 3 Zero Gravity for adjustment: Zero-G 1/Zero-G 2/ Zero-G 3, Zero-G 3 focus on the back recline, choose your preferred Zero Gravity.



Touch icon , the chair will be all open to zero gravity.

Touch icon , the chair will be resetting.

Footrest adjustment , touch   to up or lower footrest, touch the buttons to adjust the angle at any time.



Chair adjustment , touch   to up or lower the chair, touch the buttons to adjust the angle at any time.

Back adjustment , touch  recline the back, touch  up the back, touch the buttons to adjust the angle at any time.

Footrest extension adjustment , touch  to extent the footrest. touch  to retract the footrest, touch the buttons to adjust the angle at any time.

### ● Heating

Touch to enter heating adjustment page.

There are Lumbar heating and Calf heating functions, touch   to adjust the appropriate temperature.

### ● Foot roller

Touch and light up the icon, start foot roller; touch again to stop the foot roller.

### ● Kneading

Touch and light up the icon, start calf kneading; touch again to stop the calf kneading.

### ● Body Scanning

Touch and light up the icon, start body scanning again; touch again to stop the body scanning.

- **Negative oxygen ion** 

Touch and light up the icon, start to release Negative oxygen ion; touch again to stop releasing Negative oxygen ion.

- **LED**

Touch the icon, there are 5 colors of LED light for options.

- **Favorites**

If you are already logged into the user account, there will be a Favorites option on the top page, touch for favorite program record.

- **Pause**

Touch the icon, pause massage; pause again, to start massage.

- 

Touch the icon, change the body picture display.

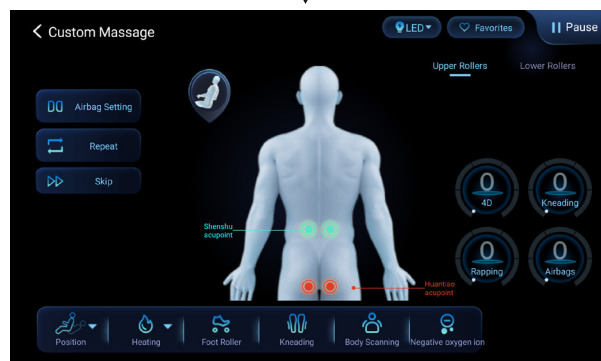
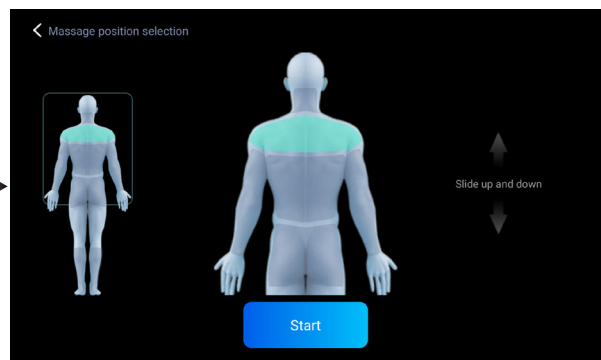
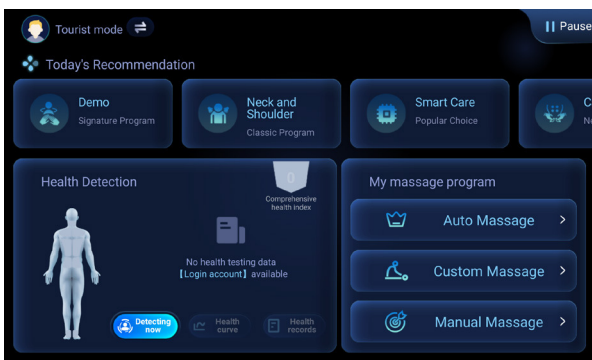

## Custom Message

Before entering custom message, there will be the page message position selection for setting. There are 5 parts of body for options: shoulder/back/arm/hip/calf, select the part of the body that needs to be massaged.

### ● Airbag Setting

Under this menu, you can choose the airbag massage for shoulders/armrest/waist/seatrest /footrest you preferred.

### ● Repeat

If you want to massage the current program again, touch the icon to massage again, touch again to next massage program.

### ● Skip

If you do not want to massage the current program, touch the icon to next massage program.

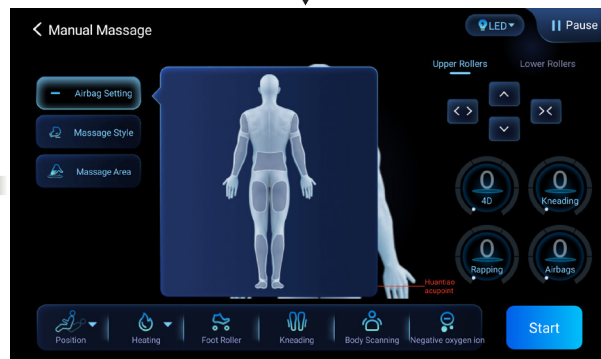
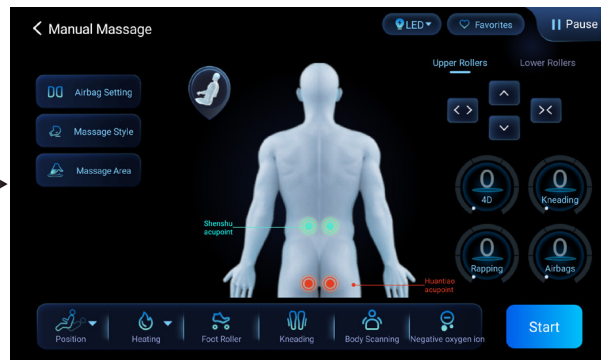
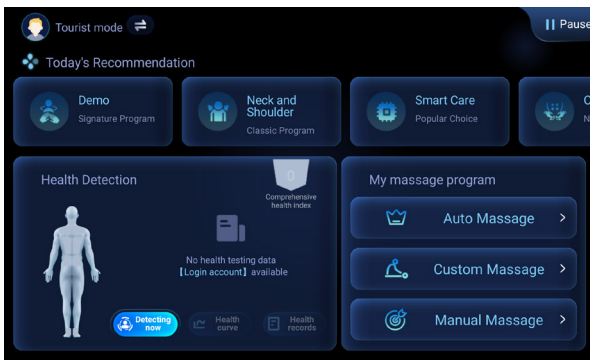

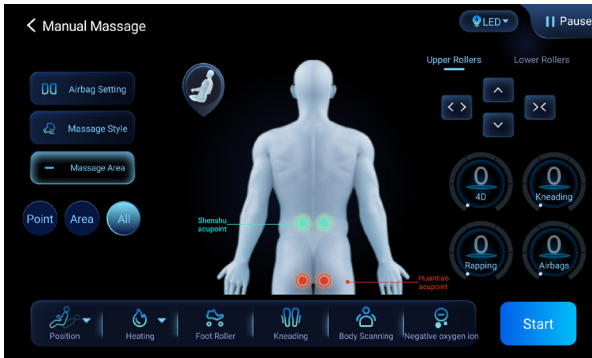

## Manual Massage

### ● Airbag Setting

Under this menu, you can choose the airbag massage for shoulders/armrest/waist/seatrest/footrest you preferred, then touch "Start" to massage.





### ● Message Style

There are Kneading/Shiatsu/Thump/Rapping/Clapping/Rolling/Scraping under this menu, choose the style you preferred, then touch "Start" to massage.

### ● Message Area

There are Point/Area/All under this menu, choose the massage area you preferred, then touch "Start" to massage.



Adjust the height and width of the massage rollers., Touch  up the rollers massage,  lower the rollers massage,  widen the width of massage rollers,  shorten the width of massage rollers.

After adjustment, touch "Start" to massage.

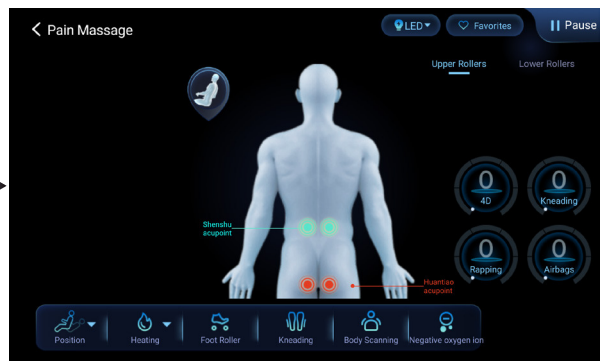
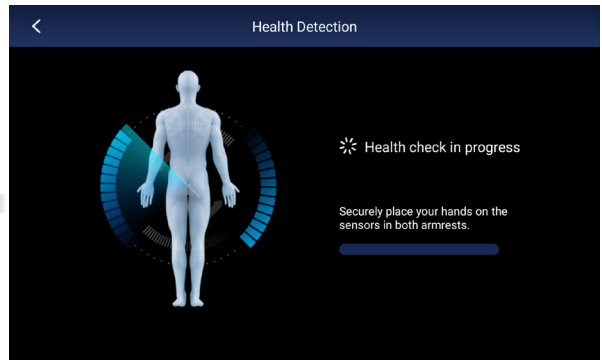
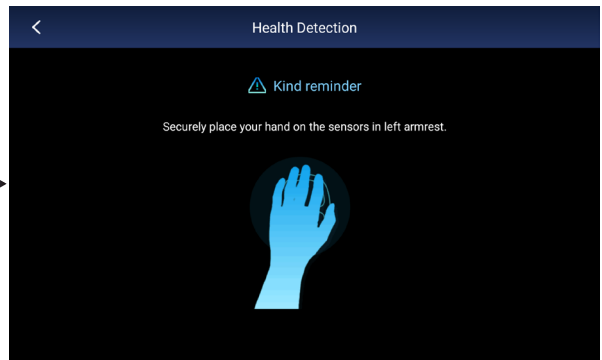
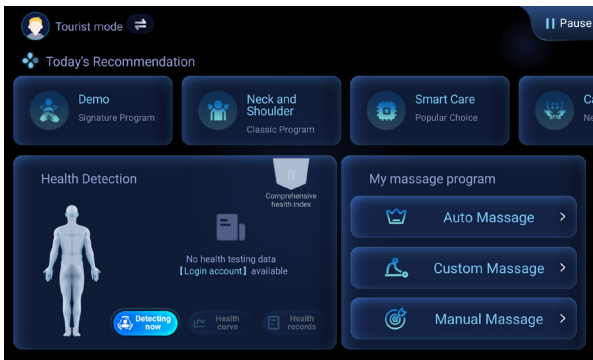

## Health Detection

- Touch "Detecting now", place your hand on the sensors in the left armrest, do not remove your hand from the sensor until the detecting is completed.
- Health result display the data of Blood Oxygen/Heart Rate/Microcirculation/HRV after detecting completed, you can also read "Health result" on home page.
- Touch "Start" to Pain Massage program.
- After detecting completed, "Health report" can be read on the home page.

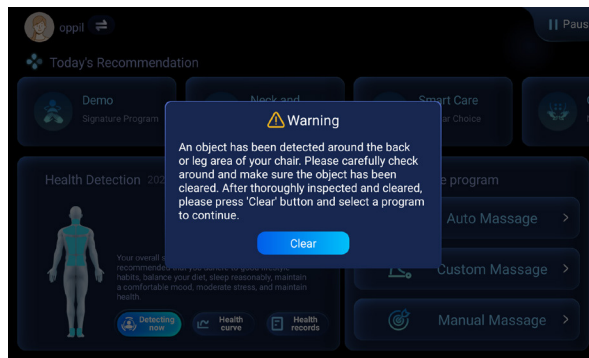

## Anti-pinch function

When the chair detect an object around the back or leg area, the screen will pop up with this warning, to remind removing the object.

## Bluetooth name: 4D Orion

### APP download

**Android** : Go to "Google Play", Search "Osaki Home" and download, choose " 4D Orion Duo Mech" to operate APP.

**Iphone** : Go to "App Store", Search "Osaki Home" and download, choose " 4D Orion Duo Mech" to operate APP.

## Voice Control:

User command	Chair Reaction
Hey Osaki / Hi Osaki	I am here
Power on	Okay, I have turned on the massage chair for you
power off	Sure, I hope you enjoyed your massage
Pause massage	okay, the massage has been paused
Continue Massage	okay, continuing massage right now
raise a little higher	As you wish
raise a little higher	I have reached the highest angle
lower chair a bit	As you wish
lower chair a bit	I have reached the lowest angle
Increase Strength	Sure, increasing intensity
Stronger massage	I have reached my maximum strength
Decrease Strength	Alright, adjusting for you
Lighter massage	Sorry, I am unable to go any lighter
Switch off Back Heater	Okay, turning off Back Heater
Switch on Back Heater	Turning on Back Heater
Do not heat the legs	Sure, right away
My legs are a bit cold	Turning on heating function
heat off	Okay, we have disabled all heating functions for you
heat on	Okay, we have enabled the heating function for you
Increase the volume	Okay, increasing the volume
Speak louder	Sorry, I can't go any louder
Decrease the volume	Okay, decreasing the volume
Set to minimum sound	I am at my lowest volume
Open airbags	Okay, we have activated the air pressure massage for you
Close airbags	Okay, we have turned off the air pressure massage for you
Massage start	Okay, I have opened a recommendation program for you. If you want to try something else, please tell me to change to another program
Change Massage	Ok, your wish is my command
Massage my neck	Alright, right away
Shoulder Massage	Okay, let me help you out
Back massage	Alright, right away
Waist massage	Sure, at once
Hip massage	Sure, at once
Leg massage	Sure, right away
Massage my hands	Okay, let me help you out
Who are you	Hello, I am your health assistant. You can wake me up by calling "Hey, Osaki". If you wish to make any adjustments during massage, please let me know as I am always at yours service. Please enjoy!
Smart massage program	Now start the massage evaluation, Please press your hands securely against the electrode pads on the arm airbag
Demo massage	Okay, we have opened the "Demo massage" program for you
Energetic Morning massage	Okay, we have opened the "Energetic Morning massage" program for you
Revitalize massage	Okay, we have opened the "Revitalize massage" program for you

User command	Chair Reaction
Sweet Dreams massage	Okay, we have opened the "Sweet Dreams massage" program for you
Care massage	Okay, we have opened the "Care massage" program for you
Thai Stretch massage	Okay, we have opened the "Thai Stretch massage" program for you
Deep Tissue massage	Okay, we have opened the "Deep Tissue massage" program for you
Fatigue massage	Okay, we have opened the "Fatigue massage" program for you
Calm massage	Okay, we have opened the "Calm massage" program for you
Relax massage	Okay, we have opened the "Relax massage" program for you
Recover massage	Okay, we have opened the "Recover massage" program for you
Gentle massage	Okay, we have opened the "Gentle massage" program for you
Smart Care massage	Okay, we have opened the "Smart Care massage" program for you
Body Circulation massage	Okay, we have opened the "Body Circulation massage" program for you
Neck and Shoulder massage	Okay, we have opened the "Neck and Shoulder massage" program for you
Lumbar Care massage	Okay, we have opened the "Lumbar Care massage" program for you

## After Massage

- 1 Turn off the power switch on the controller.
- 2 Pull the power switch to "O" position.
- 3 Pull out the power plug.



### **Warning**

- **After using, it is recommended to put the power switch to the OFF position and pull out the power plug;**  
Otherwise accidents and injuries by playing with them by children may happen.

# Cleaning And Maintenance

## Cleaning of the synthetic leather

Wipe the synthetic leather with a soft dry cloth.

- **Do not clean the product with solutions containing chemicals such as thinners, gasoline and alcohol.**
- **Be sure that leather cleaner will not harm the synthetic leather by reading the label.**
- **If the synthetic leather is very dirty, wipe it with the method below.**
  - ① Wet a soft cloth into water or 3% to 5% neutral detergent containing hot water and wring it out.
  - ② Be sure the soft cloth is well wrung out till there is NO water dripping from the cloth.
  - ③ Wipe surface of the synthetic leather with the soft cloth.
  - ④ Be sure to rinse out the cloth multiple times when wiping down.
  - ⑤ Have the synthetic leather dry naturally. Do not use dryer.
- **If it is difficult to remove the stains on the synthetic leather, try soak a piece of melamine foam into a neutral detergent to wipe down several times.**
- **Do not dry the surface by a hair dryer.**
- **Surface of the synthetic leather may fade or discolor if an inappropriate detergent is used. Test the cleaning solution in small section prior to fully applying.**
- **Do not clean the hard plastic parts with any alcohol, thinner or benzene based agents. This may cause discoloring or removal of the color all together.**



## Cleaning of the plastic parts

**1** Put a piece of soft cloth into water mixed with a neutral detergent contained hot water, wring it out and wipe the plastic parts.

- Do not clean the product with chemicals such as thinners, gasoline and alcohol.

**2** Wipe down with a microfiber or soft cloth wrung out in clean water.

- Be sure the cloth is well wrung out with no water dripping, leaving the cloth damp.

**3** Have the plastic parts dry naturally.



## Frequently Asked Questions (FAQ)

**Q** Can someone with a medical condition or disease use this product?

**A** They must consult with their physicians before using the product.

Massage can aggravate or worsen muscle injuries, bone disease, spinal abnormalities, skin disease and kill ones with medical devices implanted in their body.

**Q** Is there a restriction body height and weight to use this chair?

**A** The recommended min. height is 4'9" with a max. height of 6'4". The max. weight capacity is 280 lbs.

If the user is shorter or taller than the height range, They will not fit comfortably in the chair and may even cause injury. The maximum weight limit must be followed to avoid damaging the chair and also possibly seriously injuring yourself while using the device. The limits are in place for the users safety.

**For a taller person with knee bending when using the product:**

Tilt the backrest and lower the Lower Leg/Foot massager to the down position, elongating the length from top to bottom.

**For a short person difficult to touch the foot massage section:**

Raise the backrest and raise the legrest to shorten the distance from the top to bottom.

**Q** Where is serial number of the product?

**A** It is located at behind the backrest at the back of the chair by the power cord.



**Q** When I use the chair it makes noise .

**A** It is part of the normal function of the chair.

The chair is equipped with an air pump and multiple motors. The sounds are part of chair when being operated.

**Q** How long should I use the massage chair each day?

**A** 20 minutes per day with no medical conditions.

For the 1st week of using the chair, use only for 20 minutes at most assuming the user is in good medical condition. If there is any discomfort stop using and consult with your doctor. The first few days of using you may experience mild soreness. Be sure to monitor the pain levels and if the soreness does no diminish after the following day consult with your doctor before using again.

**BE SURE TO DRINK PLENTY OF WATER AFTER EACH MASSAGE.**

# Troubleshooting

**If an issue occurs, inspect and trouble shoot according to the corresponding method below.**

If the problem is not solved, contact the manufacturer for further instructions or service.

Fault	Cause and elimination method
<p><b>The massage wheels stop during use</b> (The product beeps and all icons and buttons on the remote controller flicker and then go out.)</p>	<p><b>As a safety protocol the massage heads will stop if pressure/weight load has exceeded its limit.</b> To avoid potentially over heating or damaging the massage mechanism the chair is designed to automatically shut off if over strained or over heated. The remote will flash a few times and then shut off as a safety measure. If this has occurred turn off the power switch from the back, allow for 30 sec. And power back on. If the weight capacity of 260 lbs is not exceeded, unplug from the outlet and notify the manufacturer.</p>
<p><b>The product cannot tilt, or the footrest cannot be raised or lowered</b> (The product beeps, the running light on the remote controller go out and the product stops)</p>	<p><b>This product will stop upon any obstruction or a too large of a force preventing from operating.</b> If all screen and buttons are flickering and the backrest or the footrest has stopped, turn off the power supply and turn back on 10 seconds. Be sure there are no obstructions in the way of the footrest or the backrest rolling mechanism.</p>
<p><b>The massage wheels cannot reach the shoulders or the neck</b></p>	<p>If your head is not properly placed against the backrest during the computer body scan, it may result in an incorrect reading, causing the rollers to start a lower position causing the massage to be inaccurate. If this occurs turn off the power from the remote and start over again to get a proper reading.</p>
<p><b>The left and right massage wheels have different heights (Intensities)</b></p>	<p>This is a normal function of the massage mechanism as it programmed to massage alternating locations from the right side during certain intervals of the program.</p>
<p><b>The chair is not functioning (massaging).</b> ● Upper body (the neck to the waist) massage ● Lower leg/foot massage</p>	<ul style="list-style-type: none"> <li>● The power line is disconnected.</li> <li>● The power switch is not turned on.</li> <li>● If no program is selected after turning, the chair will pause and shut down. Turn off and restart.</li> </ul>
<p><b>The roller heads are still warm after turning off the heat or the product is damaged.</b></p>	<ul style="list-style-type: none"> <li>● Because the roller heads heat up it will take some time for the residual heat to dissipate.</li> <li>● If the massage heads are mildly warm, the rollers may be admitting heat created by the friction from the massage.</li> </ul>
<p><b>The power line or the power plug is abnormally warm to hot.</b></p>	<p>To avoid accidents, contact an authorized service center.</p>

If above solutions are not applicable, kindly refer to “Product Warranty Card” and contact service center.

## Troubleshooting (Continued)

### Expected sounds and feelings when using the massage chair.

**If you experience any of the following sensations or sounds while using the chair, please note that they are normal functions and do not indicate a defect.**

- When chair extends or retracts you will hear gears moving and clicking.
- A rubbing sound will be mildly heard when the massage heads are activated.
- When the massage heads are tapping you may hear a mild clicking sound.
- Friction sounds will be experienced as the rollers are activated.
- As the rollers move up and down the motor produce a sound.
- As the rollers are activated you will hear spinning of belts rotating.
- Motor sounds will be experienced.
- As the massage heads are squeezing, a mild squeaking sound will be heard.
- When sitting in the chair as the roller heads are tapping and rolling a mild squeaking sound may be produced from the joints.
- Common joints that may squeak would be from the side panels
- Friction sound between the massage wheels and the fabric.
- Motors will be heard from the pump when the airbags deflate.
- While the airbags are activated you will hear air valves alternating. When the legrest is moving, you will hear mild squeak and a motor operating.



**If the sound is loud, it is also possible that the product has failed.**

- In this case, have the product inspected and repaired by an authorized service center.

### **Warning**

- **Do not refit, disassemble or repair the product without permission.** Otherwise fires, abnormal movements or personal injuries may happen.

### **Warning**

- **In the case of any abnormality or fault, stop the product immediately and pull out the power plug to avoid fuming, fires and electric shocks**

<Abnormality and fault example>

- The product fails to work after the power switch is turned to the ON position;
- When the power cable is moved the chair will turn off and on.
- In use, the product gives off a burning smell or an abnormal sound;

The product upholstery is deformed or abnormally hot.

If any of these symptoms occur, have the product inspected and repaired by an authorized service center immediately.

# Specifications

Description	Specifications
Model No.	4D Orion Duo Mech
Rated Voltage	110-120V~
Rated Frequency	60Hz
Rated current	1.4A
Timer	5/10/15/20/25/30 minutes
Dimension of Packing Carton(LxWxH)	Product carton: 74.4" x 30.5" x 34.4"
Weight	Product gross weight: 209.4 lbs
	Product net weight: 174.2 lbs
Dimension(LxWxH)	Upright: 59.4" x 29.5" x 44.1"
	Recline: 69.7" x 29.5" x 32.3"
Usage condition	Environment temperture: 50°F-104°F
	Contrasting humidity: 30-85RH
Storage condition	Storage temperture: 68°F-140°F
	Storage humidity level: 30-85RH
Safety feature	Equipped with overheated and power surge safety protection.
Using benefits	Increasing blood circulation; Relieving muscular fatigue

This equipment contains a certified radio transmission module:  
 FCC ID: 2AOC9-ZENBDM10A  
 IC: 27631-ZENBDM10A



## FCC Radiation Exposure Statement

---

This equipment complies with FCC radiation exposure limits set forth for an uncontrolled environment. In order to avoid the possibility of exceeding the FCC radio frequency exposure limits, Human proximity to the antenna shall not be less than 20cm (8 inches) during normal operation.

### FCC STATEMENT

1. This device complies with Part 15 of the FCC Rules. Operation is subject to the following two conditions:
  - (1) This device may not cause harmful interference, and
  - (2) This device must accept any interference received, including interference that may cause undesired operation.
2. Changes or modifications not expressly approved by the party responsible for compliance could void the user's authority to operate the equipment.

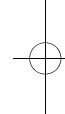
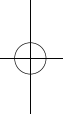

This equipment has been tested and found to comply with the limits for a Class B digital device, pursuant to part 15 of the FCC Rules. These limits are designed to provide reasonable protection against harmful interference in a residential installation. This equipment generates, uses and can radiate radio frequency energy and, if not installed and used in accordance with the instructions, may cause harmful interference to radio communications. However, there is no guarantee that interference will not occur in a particular installation. If this equipment does cause harmful interference to radio or television reception, which can be determined by turning the equipment off and on, the user is encouraged to try to correct the interference by one or more of the following measures:

- Reorient or relocate the receiving antenna.
- Increase the separation between the equipment and receiver.
- Connect the equipment into an outlet on a circuit different from that to which the receiver is connected.
- Consult the dealer or an experienced radio/ TV technician for help.



## Industry Canada Notice

---

This device complies with Industry Canada licence-exempt RSS standard(s).

1. Operation is subject to the following two conditions:

- (1) this device may not cause interference, and
- (2) this device must accept any interference, including interference that may cause undesired operation of the device.

2. Changes or modifications not expressly approved by the party responsible for compliance could void the user's authority to operate the equipment.

### **Avis d'Industrie Canada**

Le présent appareil est conforme aux CNR d'Industrie Canada applicables aux appareils radio exempts de licence.

1. L'exploitation est autorisée aux deux conditions suivantes :

- (1) l'appareil ne doit pas produire de brouillage, et
- (2) l'utilisateur de l'appareil doit accepter tout brouillage radioélectrique subi, même si le brouillage est susceptible d'en compromettre le fonctionnement.

2. Cet appareil numérique ne dépasse pas les Rèlements sur l'interférence radio par un appareil numérique de classe B stipulées dans les Règlement sur l'interférence radio d'industrie Canada.

