

1700 Serveice Menu

Model: 1700

Version: V1.0

Date : 2024-05-28

CONTENTS

I. Pillow and Cushion Assembled and Disassembled; 2

II. Wear-resistant Fabric of Mechanism Disassembled 3

III. Footrest disassembled 3

IV. side panel disassembled 5

V. Inner/Outer of side panel disassembled 7

VI. Shoulder Airbag disassembled 8

1:As photo below,unzip the zipper and remove the shoulder airbag leather 8

VII. Mainboard disassembled 8

VIII.shortcut key disassembled 9

IX.Reclining Pushrod disassembled; 9

X. Footrest Pushrod disassembled 10

XI. Mechanism disassembled 10

XII.Footrest Disassembled 12

1. Pillow and Cushion Assembled and Disassembled;

1: Unzip as below;



2: Unzip as belows photos.

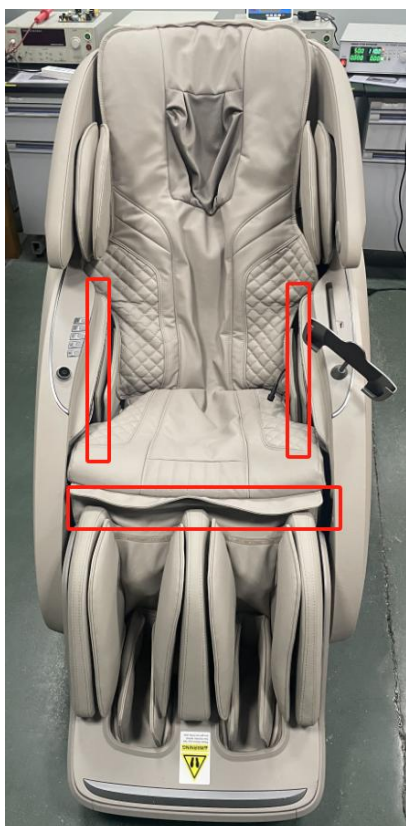

II. Wear-resistant Fabric of Mechanism Disassembled

1: unzip as below photos.

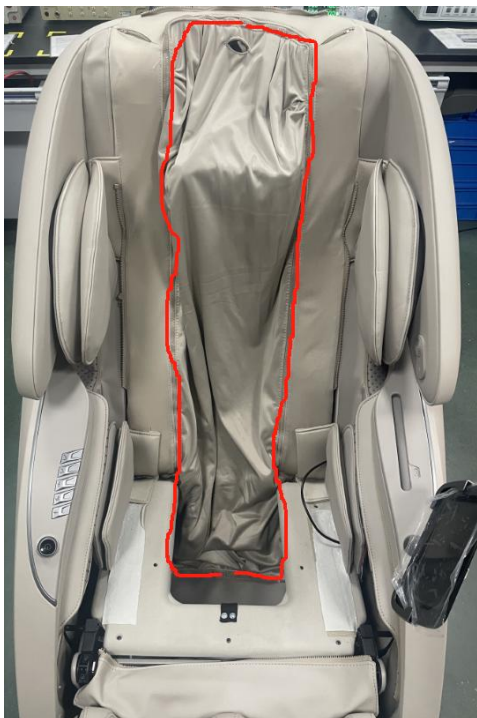

III. Footrest disassembled

1: As photo below, remove the screws on both side of footrest;



2: As photo below, disconnect the cable connector and air pipe joint;



3: As photo below, Remove the R-shaped bolt and connecting rod of footrest .

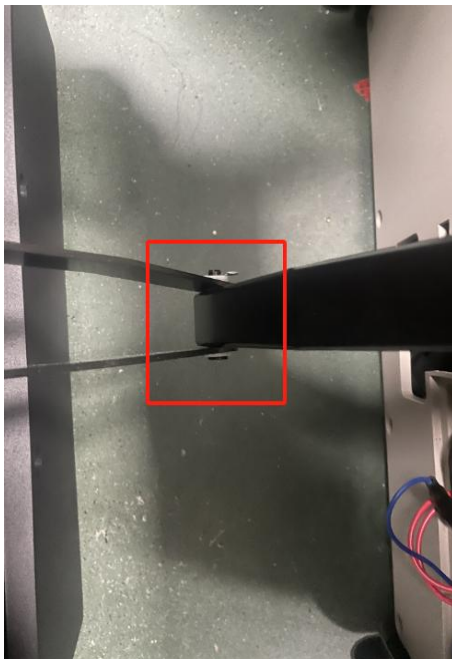

IV. side panel disassembled

1:As Photo below, unzip the cushion and remove the screws;



2: As photo below, disconnect the cable connector and air pipe joint in side panel ;



3: As photo below, lift up the side panel along the track;



4: As photo below, after lifting the panel to the limit, pull the whole panel out lightly.



5: The other side panel disassembled with same steps.

V. Inner/Outer of side panel disassembled

1: As photo below, remove all screws;



2: As photo below, remove armrest leather and then the screws behind.

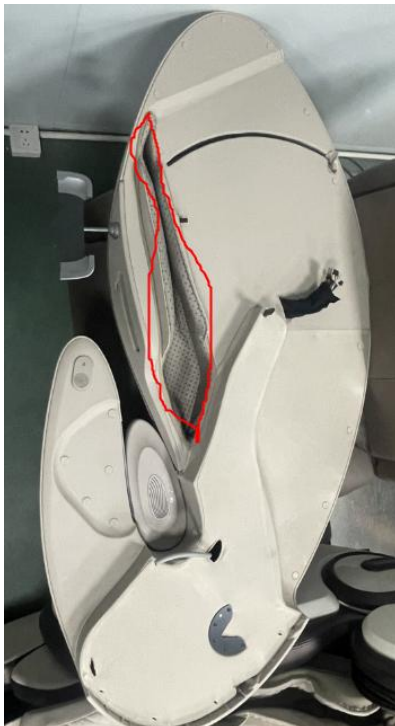

VI. Shoulder Airbag disassembled

1:As photo below,unzip the zipper and remove the shoulder airbag leather.

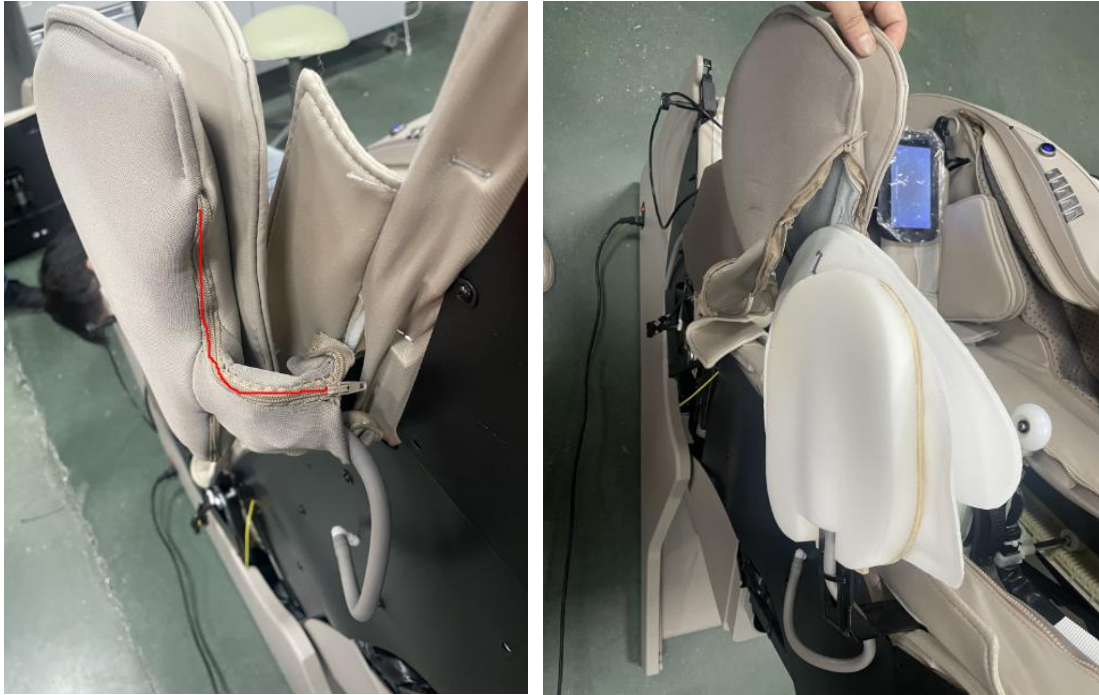

VII. Mainboard disassembled

1:As photo below, remove the screws



VIII. shortcut key disassembled

1: As photo below, open shortcut key along the seam.



IX. Reclining Pushrod disassembled;

1: As photo below, remove the two hexagonal screws at the top of pushrod on back of chair. Remove the R-shaped bolt and the plastic fixture.



X. Footrest Pushrod disassembled

1: As photo below, remove the R-shaped bolt and plastic fixture



XI. Mechanism disassembled

1: As photo below, remove the five screws on the track;

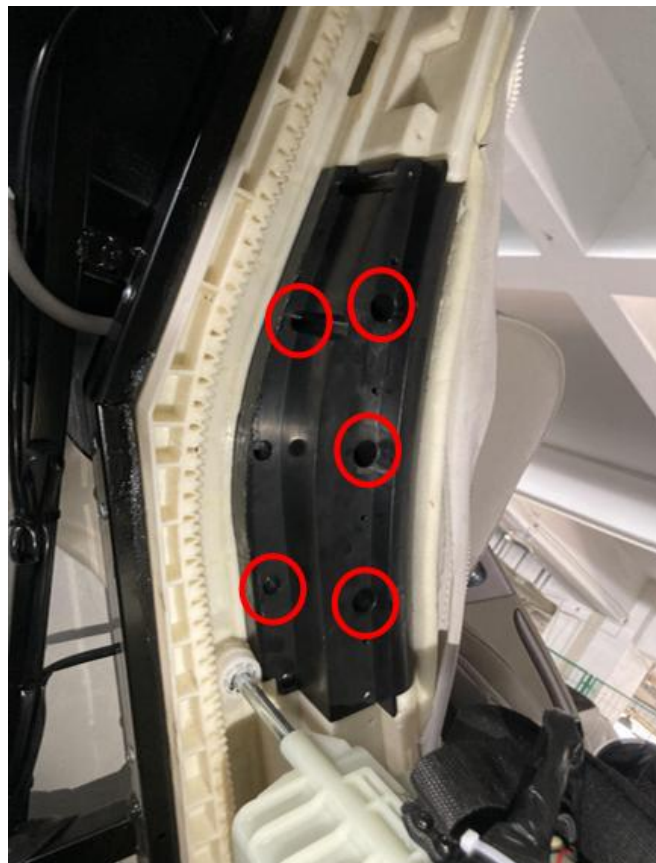

2: As photo below, take off the black position limiting component;

✘ same steps to the same part at the other side;



3: As photo below, without black plastic position limiting component, mechanism can be removed accordingly.

✘ Lower mechanism can be removed by moving it to the position where upper mechanism is removed in power on status.



XII. Footrest Disassembled

1: As photo below, remove the five screws on the back of the footrest;

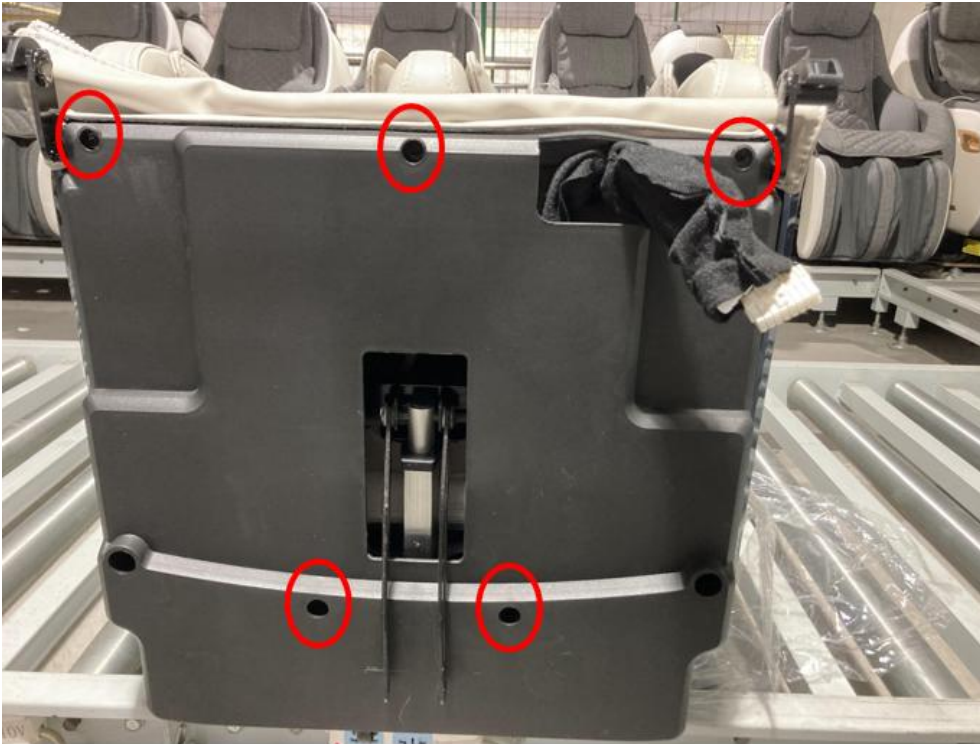

2: As photo below, After unscrews, you can take off the plastic cover of footrest;



3: As photo below, remove the two screws on both side;

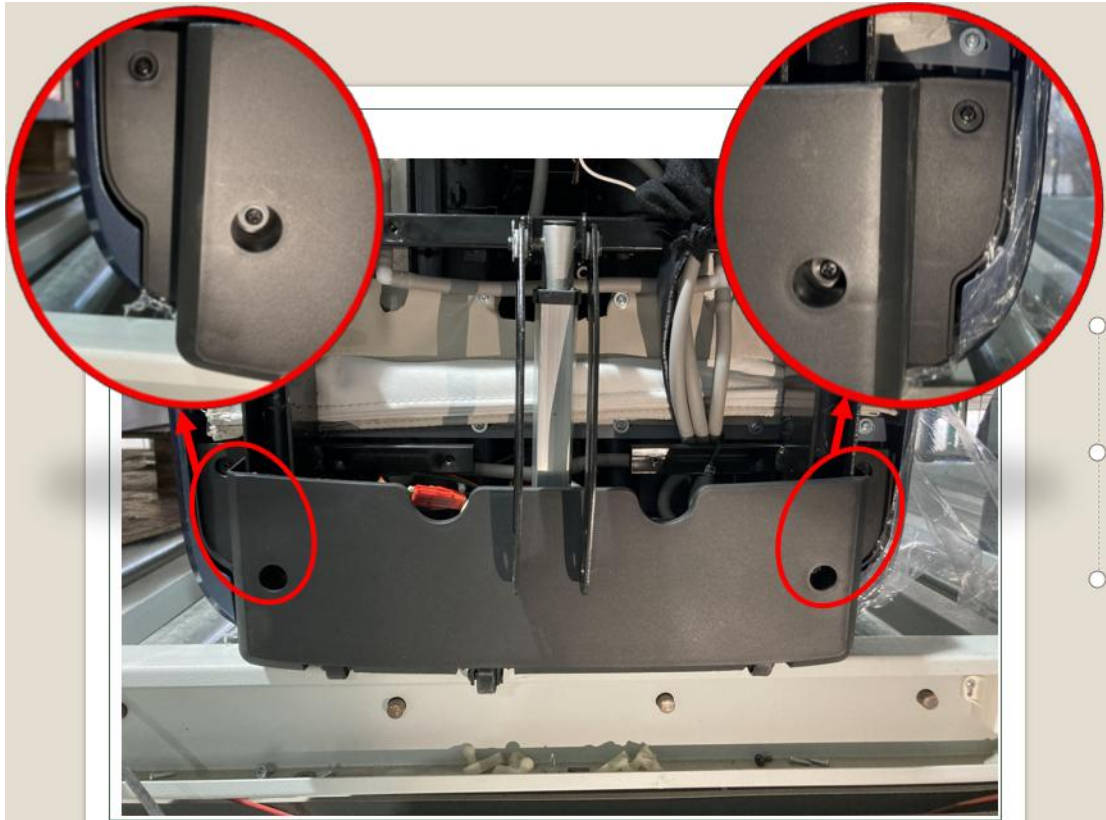

4: After unscrew, you can take off the plastic cover;

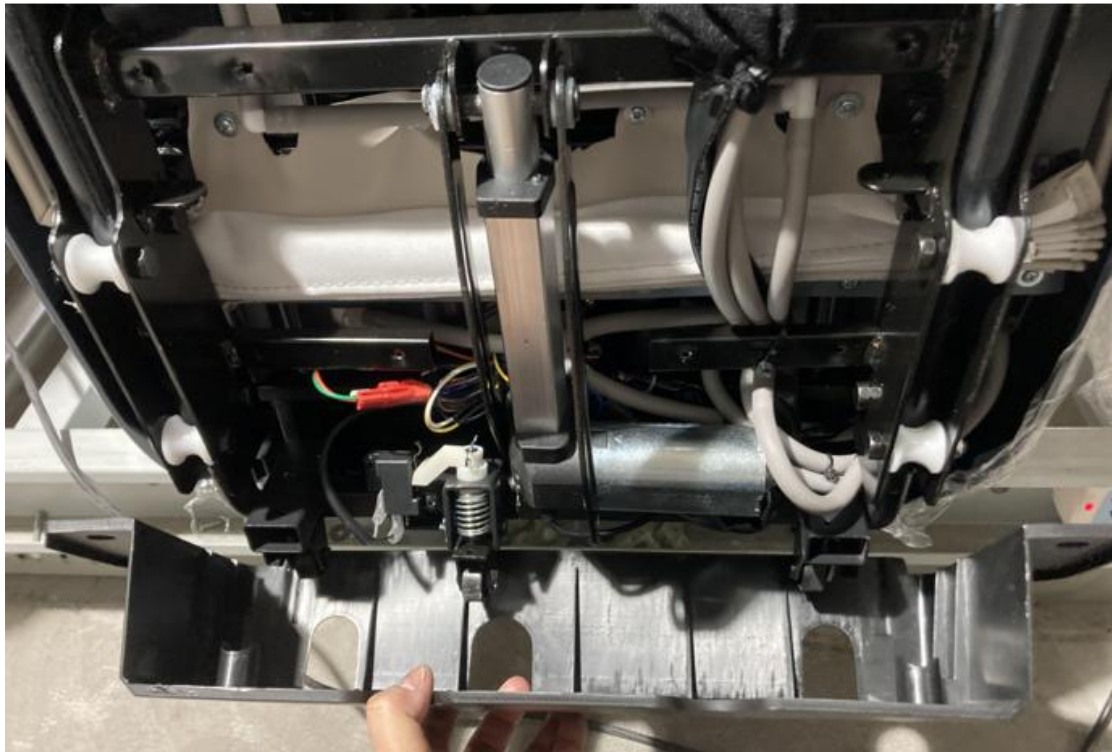

5: As photo below, remove the R- shaped bolt in the joint;



6: As photo below, turn over the pushrod, remove the R- shaped bolt in the joint again and cut the plastic fixture.

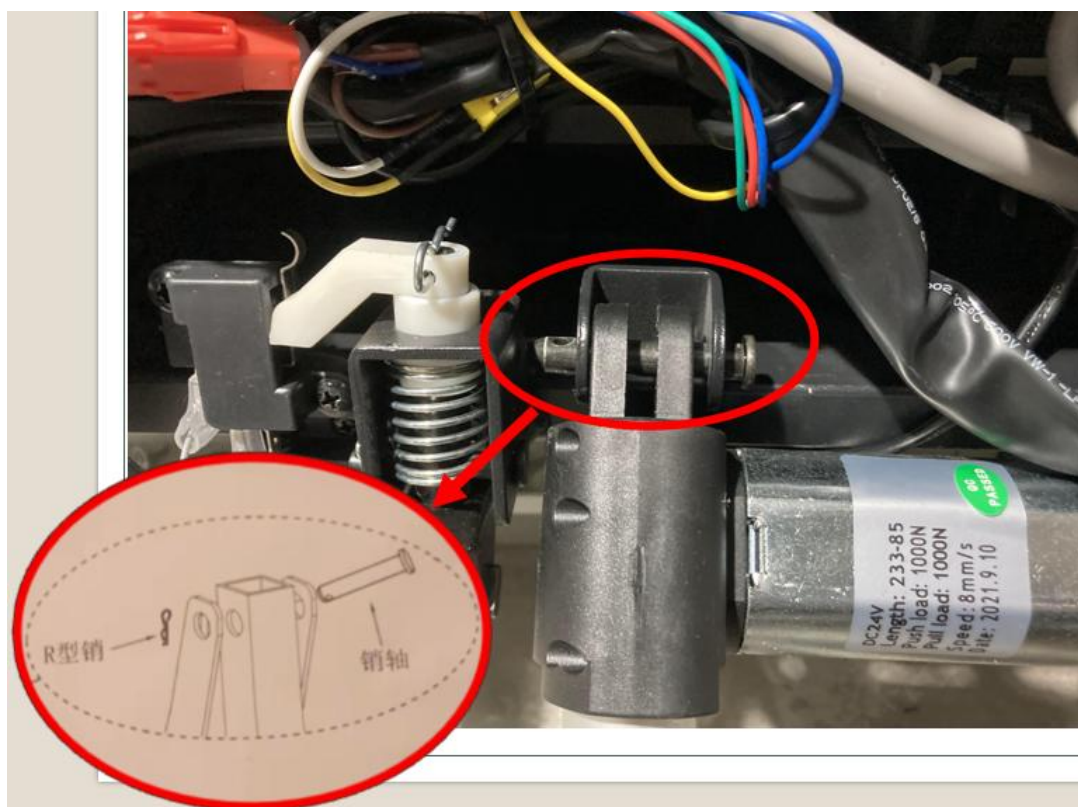

7: As photo below, cut plastic fixture.

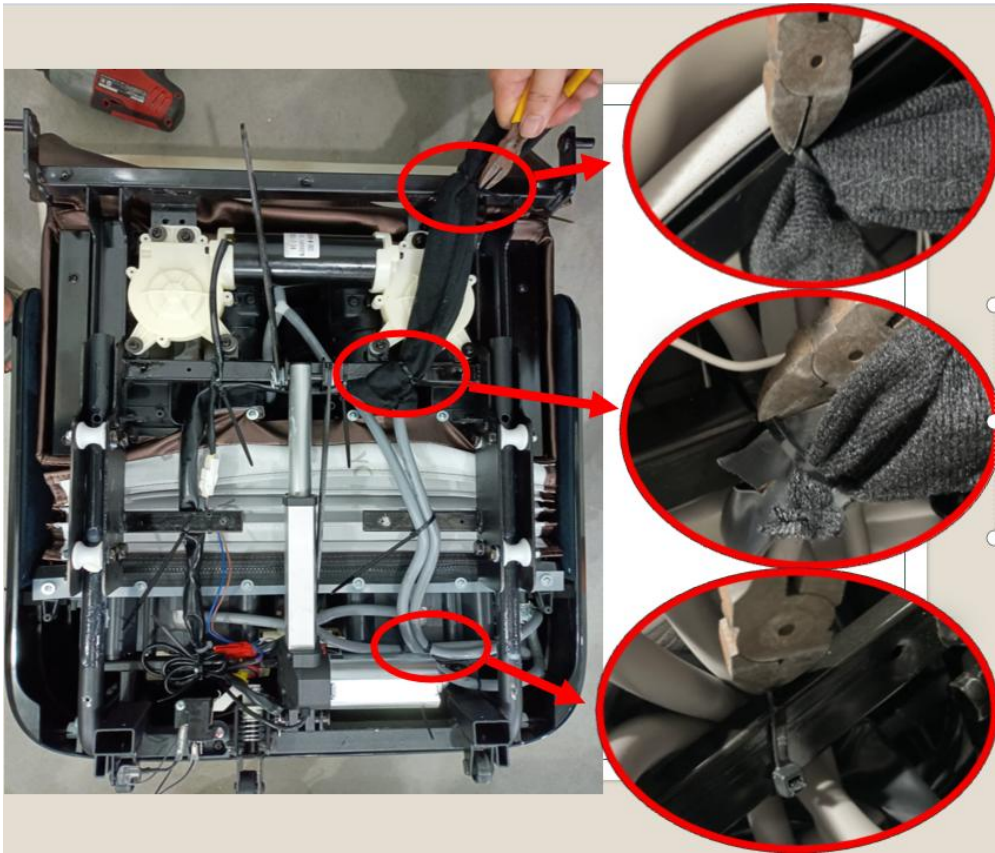

8: As photo below, extend the footrest, unzip the zipper under carf area.



9: As photo below, separate the calf and foot assembly.



10: As photo below, remove the plastic component on footrest with a plastic crowbar ;



11; take off the plastic component as photo below;



12; As photo below, remove the screws;

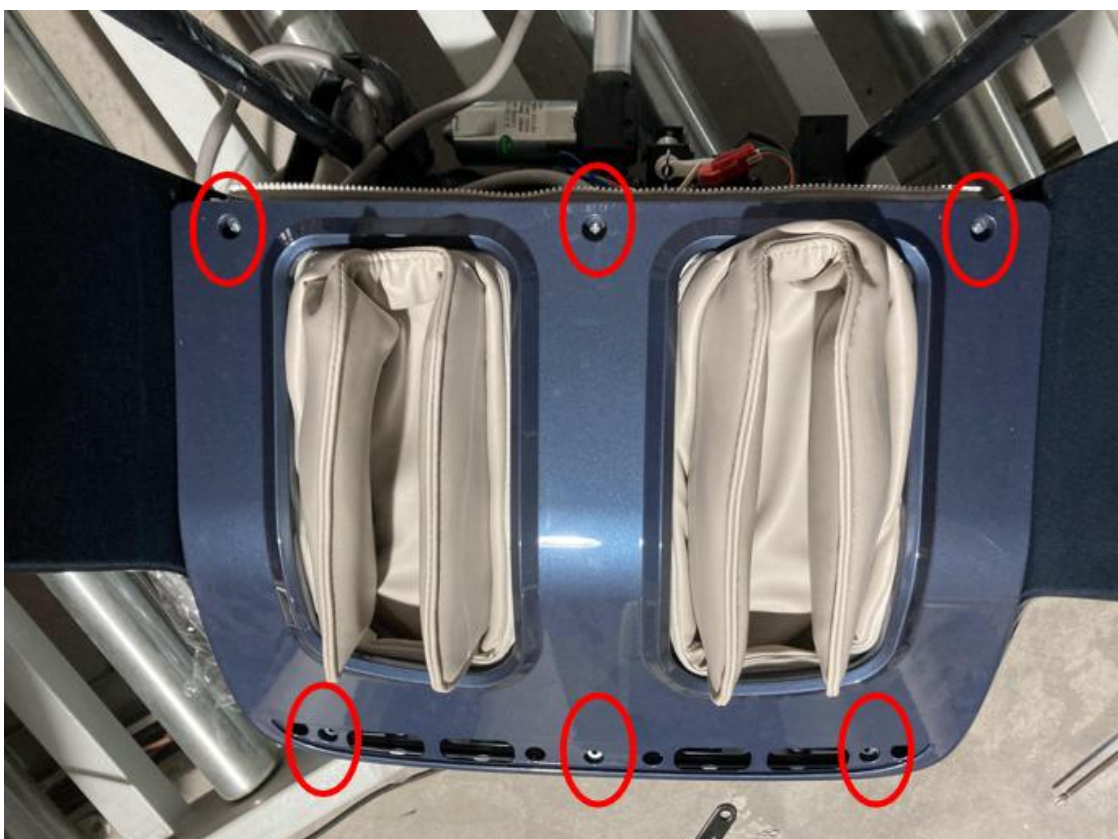

13: remove the plastic cover;



14: remove the screws as photo below;



15: devided the plastic cover as photo below;

※same step for the other side

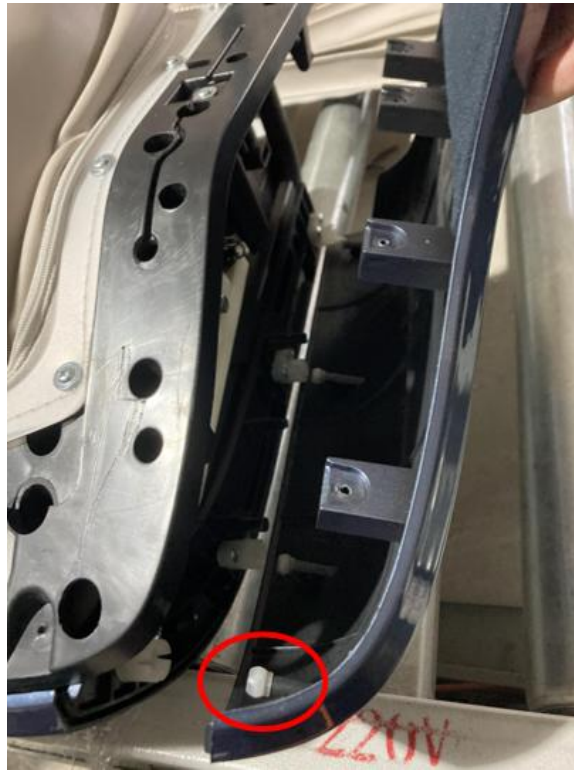

16: remove the screws as photo below;.

※ L shape tool like photo required



17: devided all the air pipe connector as photo below;

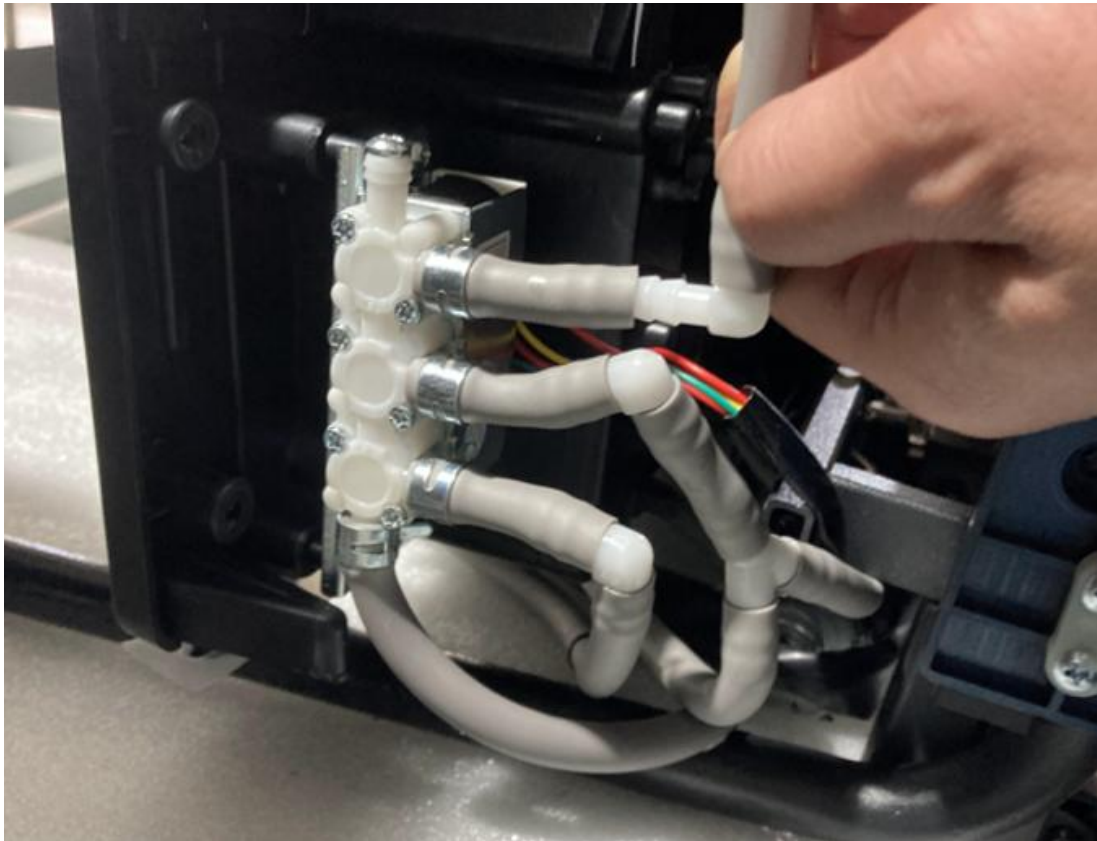

18: remove the spring at both side as photo below

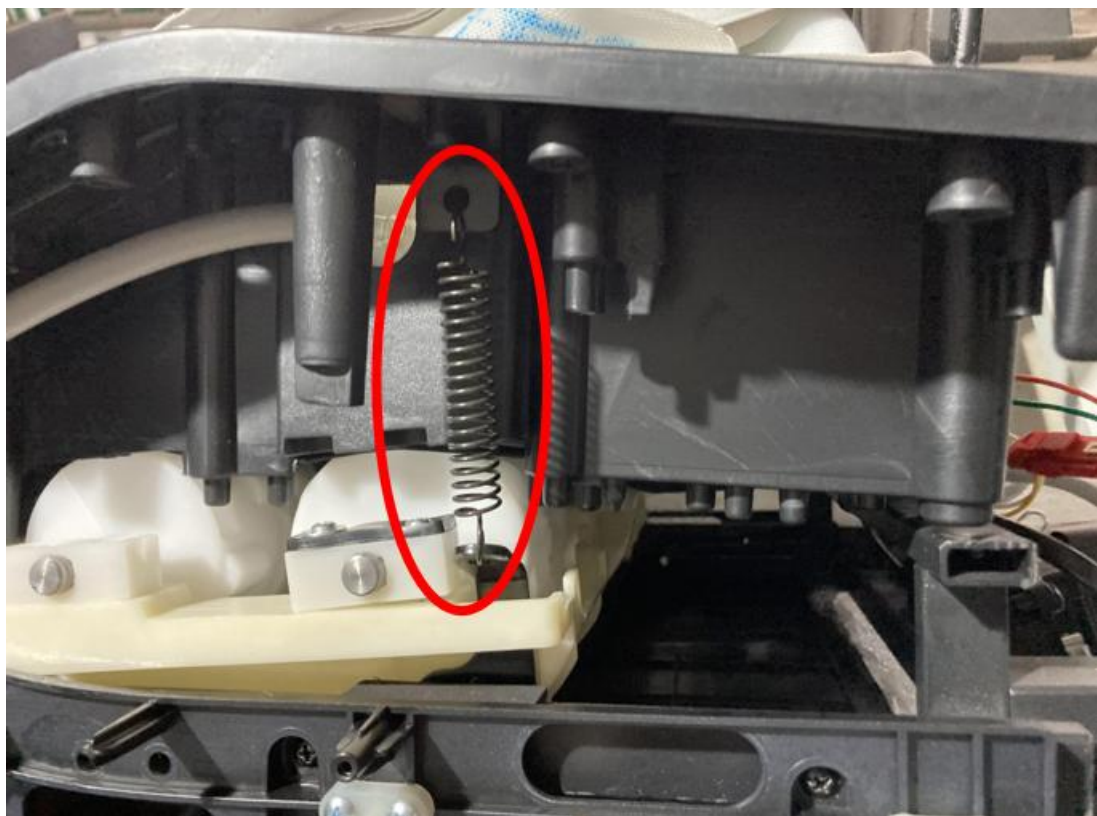

19: As photos below, remove the six screws;

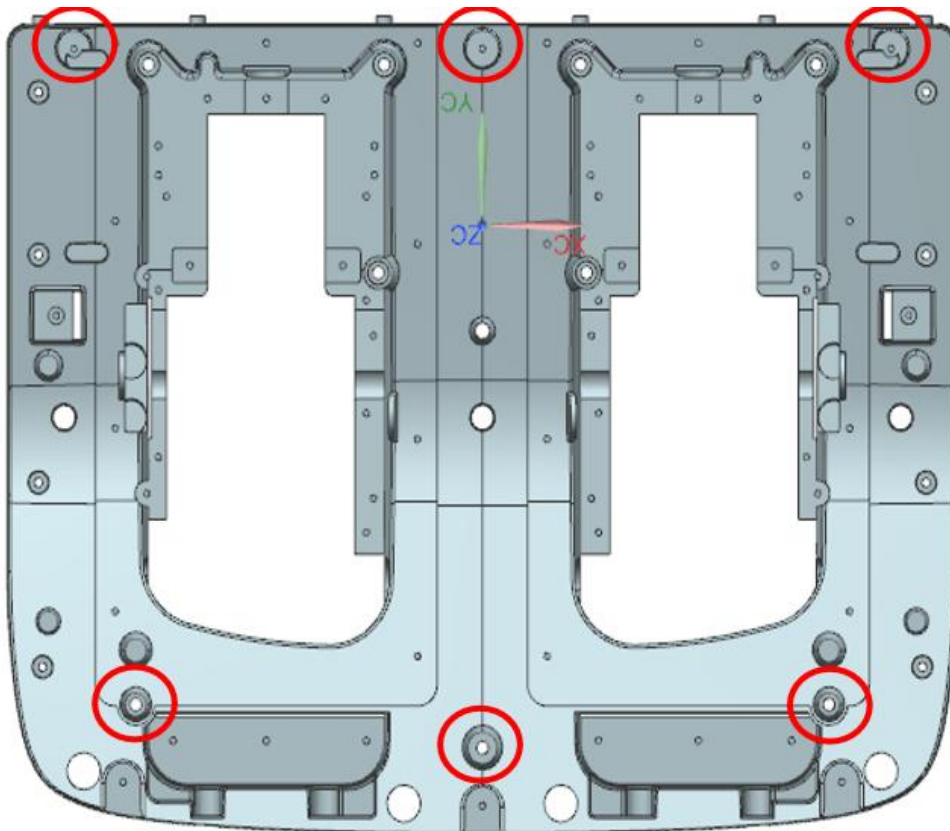

20: As photo below, plastic cover can be devided after unscrewing .



21: As photo below, remove all the screws on both side ;

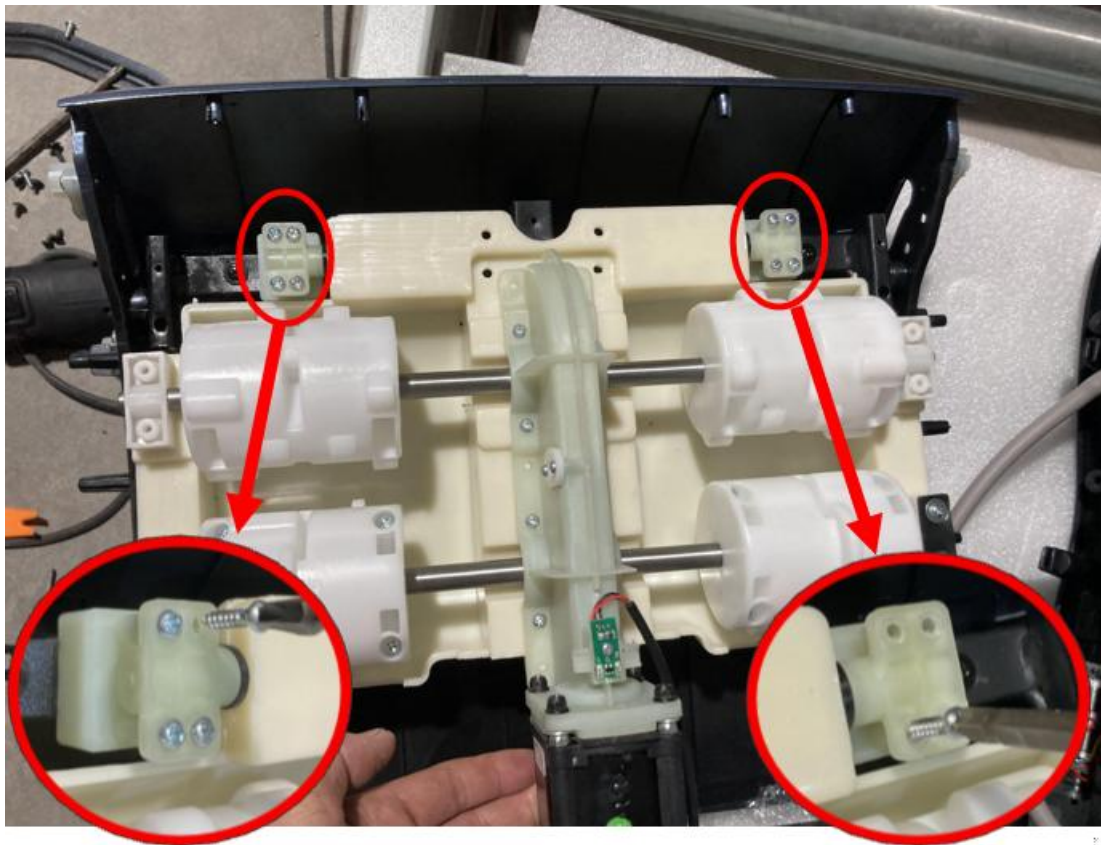

22: As photo below, divided the cable of the foot roller moter.

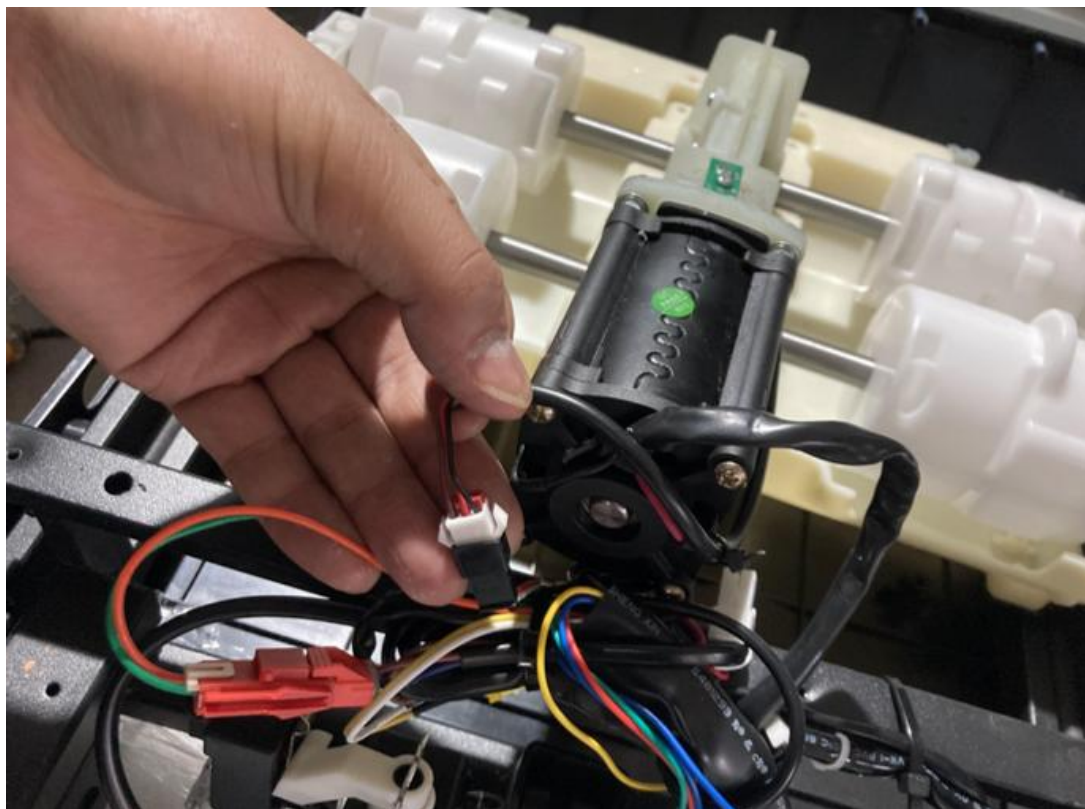

23: As photo below, moter is removable after completing the above steps.

