

# KARIOS DUO 5D+4D

## SERVICE MANUAL



---

# Contents

<b>I Product Component</b> .....	1
1. Structure .....	1
2. Key Parts .....	3
<b>II Common Faults and Troubleshooting Methods</b> .....	5
1. Massage chair inoperable, remote controller no display .....	6
2. Massage strut inoperative; other functions normal, remote controller displays normally .....	7
3. Abnormal lifting of massage mech .....	8
4. Abnormal kneading of massage mech .....	10
5. Abnormal tapping of massage mech .....	11
6. Abnormal tilting forward of massage mech .....	12
7. Whole unit/one air circuit not inflating; massage mech normal .....	13
8. Back support rod unresponsive .....	13
9. Leg support rod unresponsive .....	14
10. Abnormal screen of the remote, but the keys work properly .....	15
11. Foot roller not working .....	15
12. The leg - rubbing motor not working .....	15
13. Telescopic motor malfunctioning .....	16
14. Knee heating pad not working .....	17
15. Shawl heating pad not working .....	17
16. Speaker not working, voice malfunctioning .....	17

---

17. Anion function not working .....	18
18. Charging abnormal .....	18
19. LED light board/strip abnormal .....	18
20. Abnormal shoulder height detection .....	19
21. Massage machine heating abnormal .....	19
III. Mechanical Failures and Solutions .....	20
1. Replace the massage mech .....	20
2. Remove the armrest and shoulder assembly .....	20
3. Remove the front backrest plastic body assembly .....	22
4. Remove the power box assembly .....	22
5. Remove the leg and foot assembly .....	23
VI. System Connection Diagram .....	27

I Product Component:

1.RK7602EA Structure

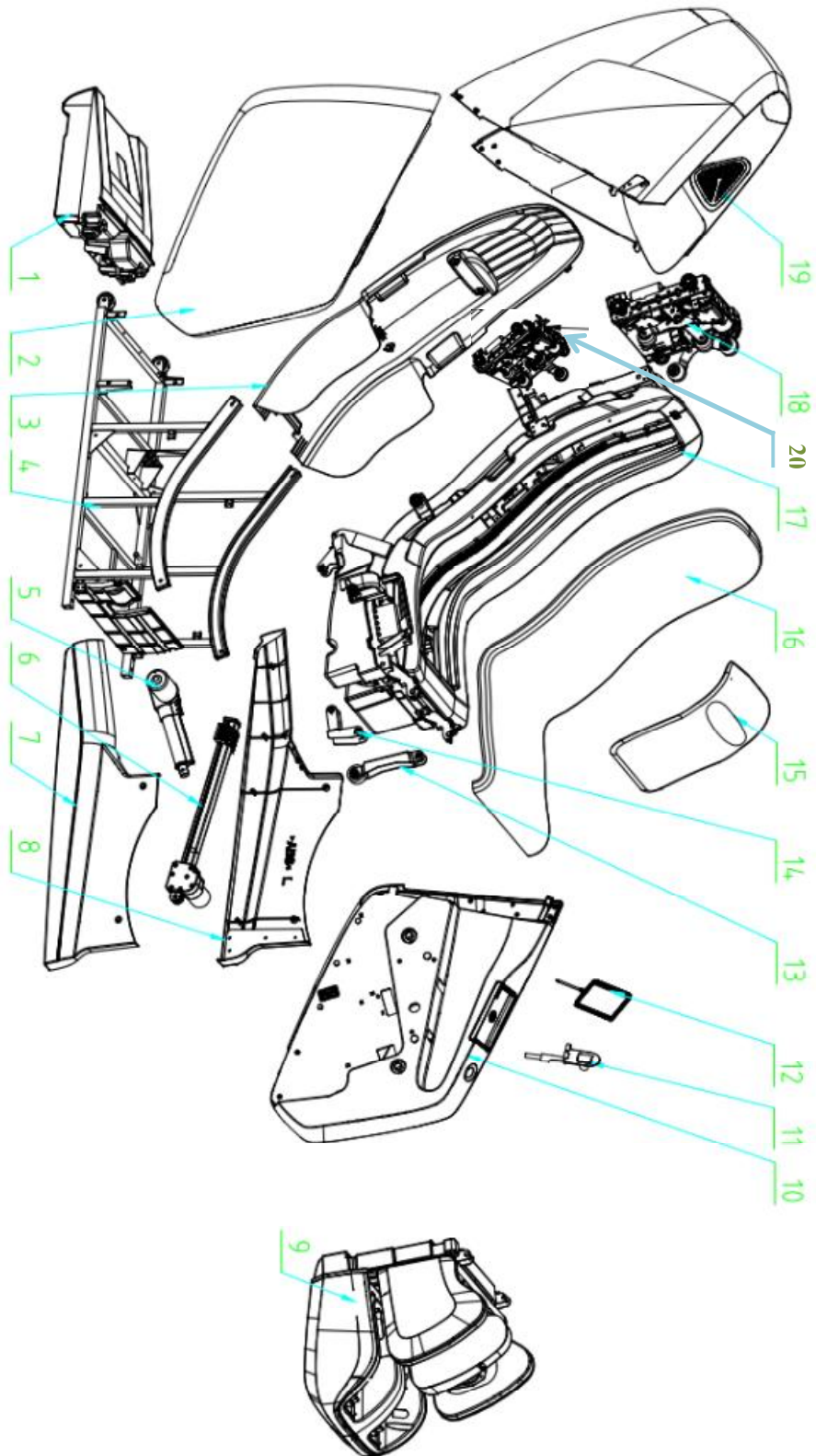

S.N	Code	Item	Qty
1	RK7602.1.3	Power Box	1
2	RK7602.4	Right Armrest	1
3	RK7601.5.3-1	Back Cover	1
4	RK7602.1	Frame	1
5	30723059	Leg Actuator	1
6	30723063	Back Actuator	1
7	RK7601.1-3	Right Fender	1
8	RK7601.1-2	Left Fender	1
9	RK7602.2	Legrest	1
10	RK7602.3	Left Armrest	1
11	RK7602.3.8	Remote supporter	1
12	RK7602EA@001.CMC.0	CMC Remote	1
13	RK7601.5.3-7	Connect Rod	1
14	RK7601.5.1-6	Actuator Support Component	1
15	RK7602.7.10	Shoulder Cushion	1
16	RK7602.7.11	Back Cushion	1
17	RK7602.5	Back Pad	1
18	RK11SM.0	Upper Roller	1
19	RK7602.7	Shoulder Assembly	1
20	RK11SGA.0	Lower Roller	1

## 2.Key Parts

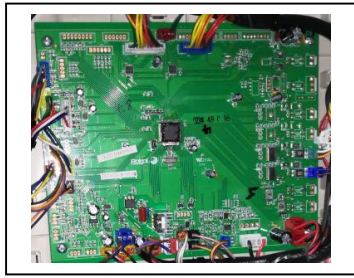

PCB

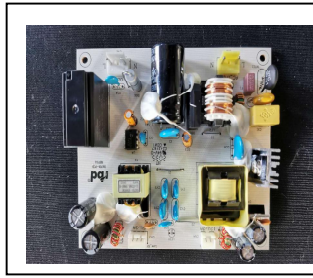

Power PCB

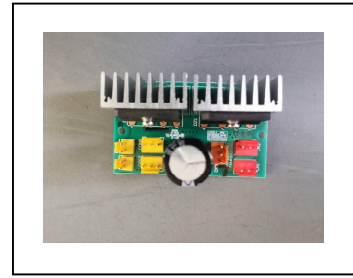

Rectifier Board



Filter

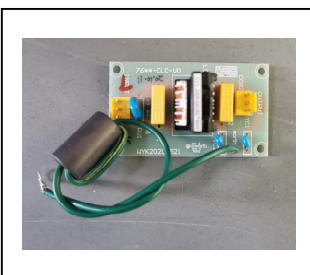

Filter Board

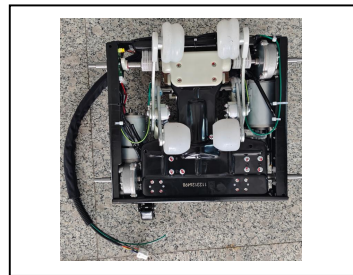

Upper Roller

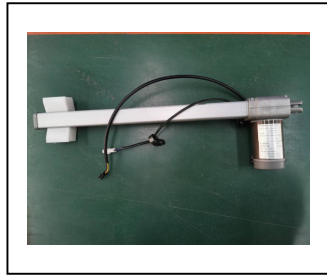

Back Actuator



Leg Actuator

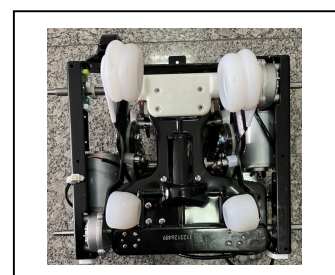

Lower Roller

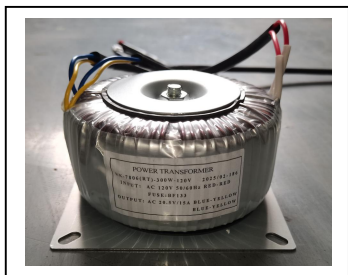

Transformer

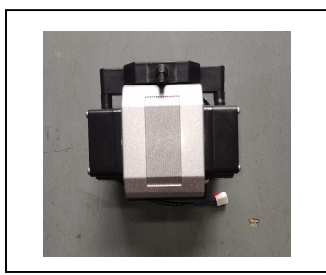

Air Pump



Remote

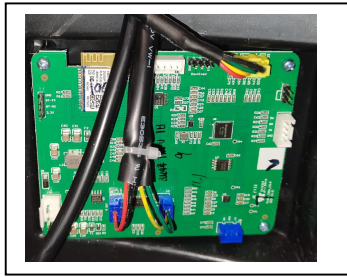

Voice Board

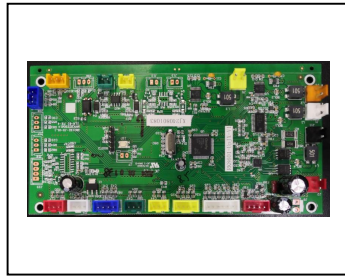

Upper roller Board

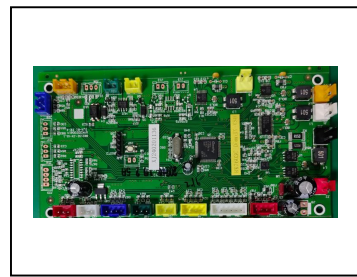

Lower Roller Board



Quick Button

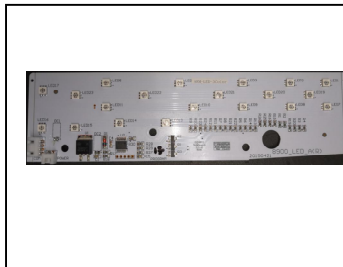

LED light

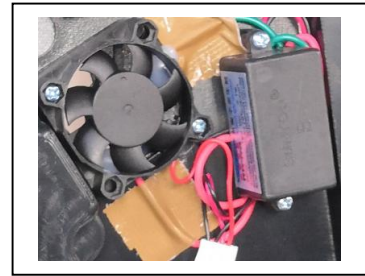

Anion Assembly

## II.Common Faults and Troubleshooting Methods

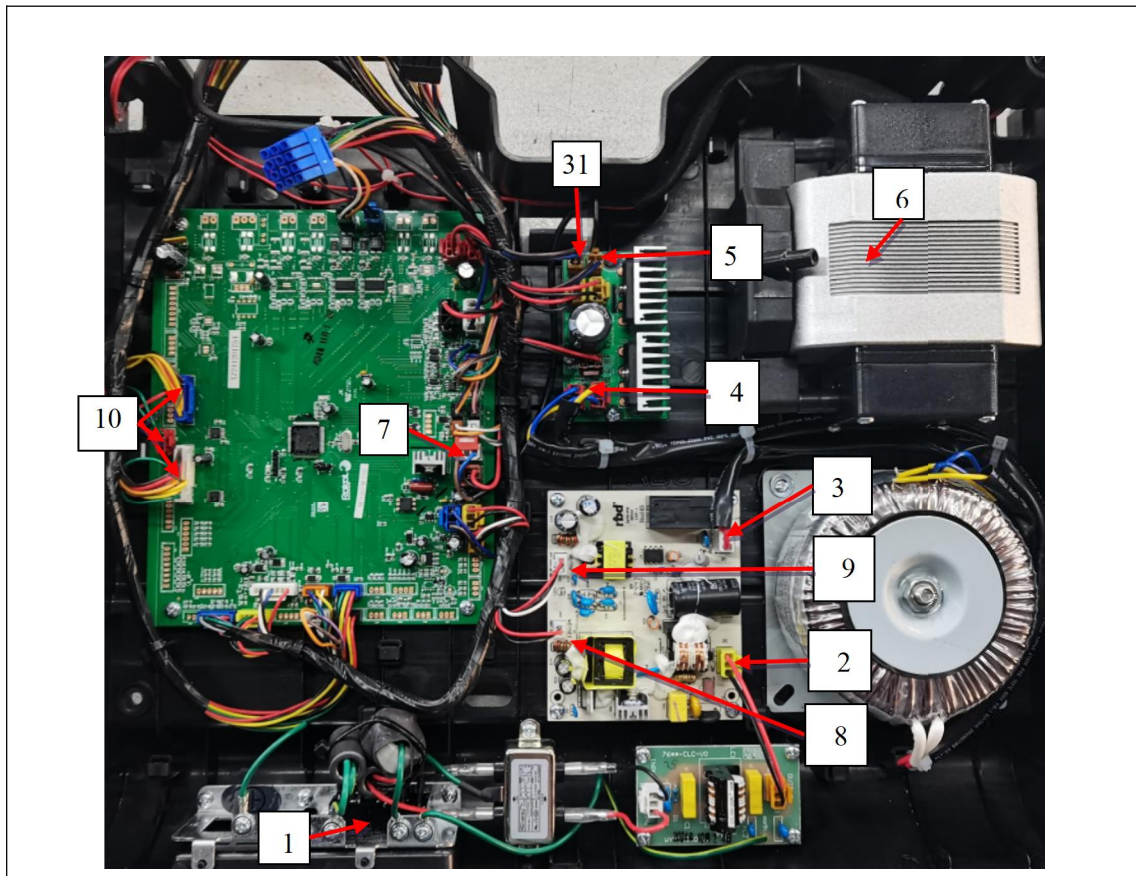

电器连接图

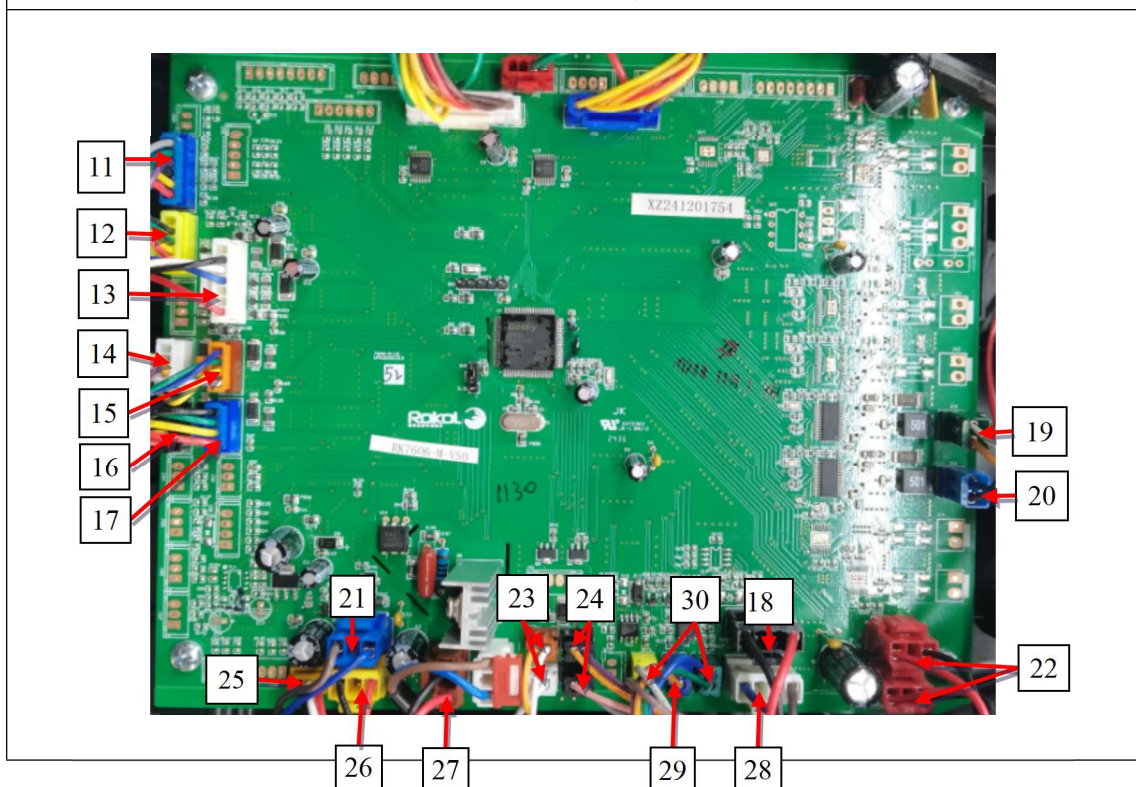

S.N	Port Function	S.N	Port Function	S.N	Port Function	S.N	Port Function
1	3in1 Switch	9	Standby DC5V	17	Lower roller port	25	Standby 5V
2	Power input(120V)	10	Solenoid Valve	18	Leg power	26	DC12V
3	Transformer input(120V)	11	Actuator counter signal	19	Leg Actuator	27	AC24V
4	Transformer output(20.5V)	12	Quick Button	20	Back Actuator	28	Lower roller power
5	Charge input(DC24V)	13	Remote	21	Bluetooth power	29	Shawl Heat
6	Air pump	14	Voice Board Port	22	DC24V input	30	Light Board
7	Air pump power	15	Leg Board Port	23	LED	31	Upper roller power
8	DC12V output	16	Upper roller port	24	Anion	32	

Upper,Lower roller board PCB Chart (Lower roller with no heat)

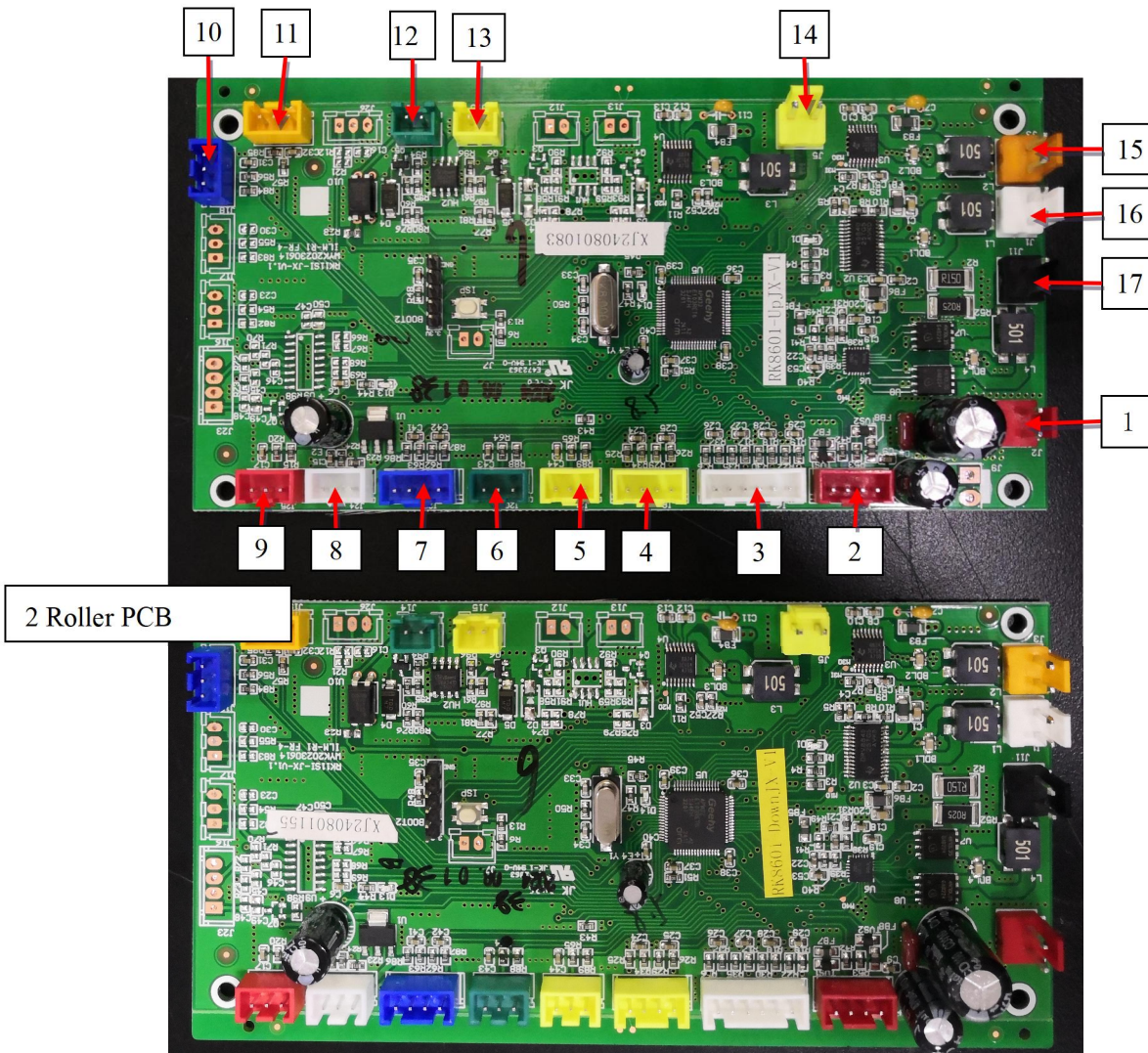

S.N	Port Function	S.N	Port Function	S.N	Port Function
1	Roller power	7	lift limit	13	Left Roller heat
2	Port signal	8	Anti collision signal	14	Forward Motor
3	Width signal	9	Kneading Counting	15	Lift Motor
4	Forward limit	10	Right roller arm signal	16	Tapping motor
5	Lift counting	11	Left roller arm signal	17	Kneading Motor
6	Forward counting	12	Right Roller Heat	18	

## 1. Massage chair inoperable, remote controller no display

1.1 First, check if the socket has power. Turn on the 3-in-1 switch. Check if the fuse of the 3-in-1 switch (marked as 1 in the diagram) is blown. If the fuse is blown, replace it and the device should work normally.

1.2 Use the AC voltage mode of a multimeter to measure the voltage at 2 Power Input (AC220V). If the voltage is abnormal, check if the filter is faulty or if the connection is abnormal.

1.3 Use the DC voltage mode of a multimeter to measure whether the voltage at 9 Standby DC5V (DC5V) is normal. If there is no voltage, check if the connecting wire between the power board and main board has proper connection. If there is no problem, the power board is faulty and shall be replaced. Measure whether the standby voltage (white and black wires) is at a high level. If it remains unchanged, the main board is faulty.

1.4 Use the AC voltage mode of a multimeter to measure the voltage at 3 Transformer Input (AC220V) and 4 Transformer Output (AC20.5V). If the voltage at 3 is normal but there is no voltage at 4, the transformer is faulty and shall be replaced.

1.5 Use the DC voltage mode of a multimeter to measure whether the voltage at the flat connector is normal. If not, replace the main board. Check if the connecting wire of the hand controller has poor contact. If not, replace remote controller. Simple Hand Controller Inspection Method: Follow the above steps.

## 2. Actuator inoperative; other functions normal, remote controller displays normally

2.1 Use the DC voltage mode of a multimeter to measure whether the voltage at 22 DC24V Input (DC24V) is normal. If there is no voltage,

measure whether there is DC24V output at 5 Rectifier Board Output. If there is no output, use the AC mode to measure 4 Transformer Output (AC20.5V). If there is voltage, the rectifier board is faulty and shall be replaced.

### 3.Abnormal lifting of massage mechanism

3.1 When massage machine operates in the up and down state, the lifting and lowering functions of the massage mechanism fails to work;

3.1.1 Turn on remote controller to manually operate the massage machine run entire process. Use a multimeter in the DC voltage mode to measure whether there is voltage output at the connector marked as 15 in Figure 2 of the roller board. If no voltage is detected, the roller board is faulty and should be replaced.

3.1.2 If the voltage is normal, disconnect the connector and use a multimeter in buzzer mode to measure the continuity of the red and black wires from the roller board to the white three-core 450B connector of the lifting motor. Check whether the mating connector is securely fastened and whether the terminals are in good contact. If both wires are connected properly, it indicates that the lifting motor is faulty and requires replacement or the mechanism. If there is a disconnection in either wire, the mating wiring harness must be replaced

3.1.3 To determine whether the lifting motor is damaged, set the multimeter to the resistance mode and measure the resistance between both ends of the lifting motor connector. If there is no resistance or the resistance is too high, the motor is damaged.

3.2 When the massage machine is working in the up and down mode, if there is a phenomenon of top or bottom stuck (exceeding the limit); The upper and lower limit signals of the lifting motor are faulty.

3.2.1 Check whether the connector at the 7 lifting limit position in Figure 2 of roller board is detached from the connector on the upper and lower limit board in the red box on the right, and whether the connector terminals are detached.



3.2.2 Measure whether there is DC5V at both ends of the red box connector in the right figure. If it is normal, check whether there is a high or low level change in the lifting limit Hall element (use magnetic steel to approach or leave the Hall element, measure the upper or lower limit connector pins 2 and 3 in the red box). If there is no level change in pins 2 and 3, replace the lifting limit board.

3.2.3 Disconnect the connectors at 7 in Figure 2 and use a multimeter buzzer to measure the continuity of the wiring harness between the roller board and the upper and lower limit boards. If both are connected, it indicates that the roller board is damaged and can be replaced; If it doesn't work, replace the corresponding lifting limit harness.

3.3 If the massage machine does not work in a certain area of the shoulder, back or waist, the massage machine run through the entire process; There is a signal fault at the 5 up and down counting points in Figure 2 of roller board.

3.3.1 Check if the connector between the roller board and the forward tilt motor limit board has come loose, and if the terminals have come loose. Unplug the signal input wire from the limit board of the forward tilt motor in the figure on the right, and measure the on/off status of the corresponding roller boards 4, 5, and 6 (red, brown, orange, yellow, blue, and black) for red, yellow, orange, blue, and black. If they do not work, replace the forward tilt signal harness.

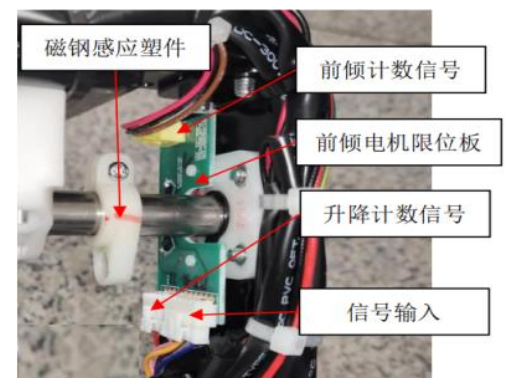

3.3.2 If both are connected, make the massage machine work in the up and down states. Use a multimeter DC voltage range to measure whether there is DC5V voltage on the red and black wires of the forward tilt limit board signal input in the above figure. If not, the roller board is damaged. If there is, measure whether there is a high or low level change between the brown and black wires of the lift counting signal. If not, the lift motor counting is damaged and shall be replaced; During the maintenance process, do not adjust the position of the magnetic steel induction plastic part and the Hall element of the forward tilt motor limit plate, otherwise it may also cause counting faults in the up and down movement or forward tilt of the movement

3.4 Upon startup, the program initiates the shoulder height detection process. If the massage machine stops immediately upon slight movement at the upper limit, it indicates a shoulder height detection malfunction. Inspect the lifting motor and replace it if necessary, then test the shoulder height function. If the issue persists, replace the roller board. Follow the abnormal shoulder height detection troubleshooting steps to inspect the lifting motor. If the massage machine fails to detect the shoulder during downward

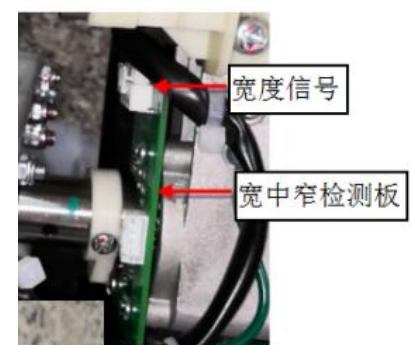

movement, first check whether the mechanism is in the wide position. If not and the magnet is installed correctly, replace the width detection board (following the abnormal tapping width troubleshooting steps). Next, verify whether the forward tilt motor extends properly. If it does not extend, proceed with the forward tilt motor malfunction troubleshooting steps to test the forward tilt function.

3.5 Abnormal collision prevention switch. Between the upper and lower limit positions, after the mechanism collides, the lifting motor fails to stop, indicating an abnormal collision prevention switch.

3.5.1 Inspect whether the connector is securely plugged in and the terminals are loose or not, disconnect the 8 anti-collision switch, and use the buzzer function of a multimeter to measure the continuity of the wiring harness. If abnormal, replace the corresponding wiring harness assembly.

3.5.2 Use the buzzer function of a multimeter to measure the red and black wires of the anti-collision switch. Press and release the anti-collision switch to verify whether the switch conducts and disconnects properly. If abnormal, replace the anti-collision switch wiring harness assembly. Otherwise, replace the roller board

3.6 If the lower mechanism remains stationary at the lower limit position and the signals and circuits are checked to be normal, inspect whether the upper mechanism's anti-collision switch is open-circuited or the connector is disconnected. Conversely, if the upper mechanism remains stationary at the upper limit position and the signals and circuits are checked to be normal, also inspect whether the lower mechanism's anti-collision switch is open-circuited or the connector is disconnected.

#### **4.The massage machine kneading abnormal.**

4.1 Massage machine has no kneading action

4.1.1 Turn on remote and manually control the massage machine to give kneading commands. Use a multimeter in DC voltage mode to measure whether there is a DC9-20V voltage output at the terminal of the connector at the kneading motor on roller board 17. If there is no voltage output, roller board is damaged and shall be replaced

4.1.2 If there is voltage output, check if the 17 to kneading motor harness connectors are secured and if the terminals are in good contact. If everything is normal, unplug the connector and use a multimeter buzzer to measure the continuity of the red and black wires from connector 17 on the roller board to both ends of the black two core 450B connector. If both are connected, it indicates that the kneading

motor is broken and the roller needs to be replaced; If it doesn't work, the kneading motor harness assembly needs to be replaced; The method for determining whether the kneading motor is damaged is the same as the method for determining the lifting motor in section 3.1.3.

4.2 Once the massage chair is turned on, the kneading function will run. If it cannot be turned off through tablet operation, the roller board is damaged and shall be replaced.

## 5. Abnormal tapping function of the massage machine

5.1 The massage machine has no tapping action

5.1.1 Turn on the manual control to give tapping commands. Use the DC voltage mode of the multimeter to measure whether there is a DC9-20V voltage output at both ends of the 16 tapping motor connector on the roller board. If there is no voltage, the roller board is damaged and shall be replaced.

5.1.2 If the voltage of the roller board is normal, check whether the mating connector from the roller board to the tapping motor is secure and whether the terminals are in good contact. If everything is normal, unplug the connector and use a multimeter buzzer to measure the continuity of the red and black wires from connector 16 on the core board to the white two core 450B connector. If both wires are connected, it indicates that the tapping motor is broken and the mechanism needs to be replaced. If the two wires are not connected, the tapping motor harness assembly needs to be replaced; The method for determining whether the tapping motor is damaged is the same as the method for determining the lifting motor in section 3.1.3

5.2 Once the massage chair is turned on, the tapping function starts running. If it cannot be turned off through tablet operation, the roller board is damaged and needs to be replaced.

5.3 Open the tablet to operate in tapping mode. If the width cannot be selected or are incorrect, then the roller's width signal is faulty. Measure the red and black wires of

the connector at the 3-wide, medium, and narrow signal positions on the roller board with a multimeter in DC

voltage range to see if there is 5V/DC output. If there is no output, the roller board is damaged. After replacement, it returns to normal. If there is voltage output, check if the connector for the width signal of the roller from point 3 of the roller board to the right is securely plugged in and if there is any terminal detachment. If everything is normal,

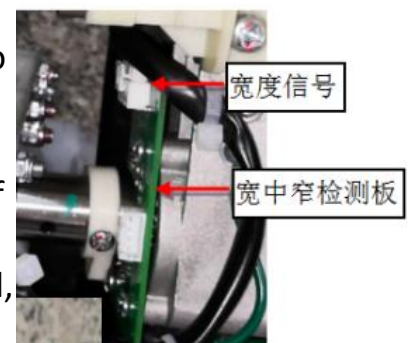

use a multimeter buzzer to measure the on/off status of the red, brown, yellow, and black signals at three locations up to the width signal end shown in the right figure. If it doesn't work, replace the wide, medium, and narrow detection signal harness assembly. If both are connected, use a magnet to approach and move away from the Hall element, and measure whether there is a voltage change between the brown, black, yellow, and black lines. If there is no change, it means that the wide, medium, and narrow detection board is damaged. After replacement, it works normally. Otherwise, replace the roller board.

If you choose the width, keep kneading. Use a multimeter to measure the DC voltage range to see if there is a DC5V voltage on the red and black lines at the counting point on the roller board 9. If not, replace the roller board; Measure whether there is a high or low level change between the yellow and black lines, and replace the core board if there is. Use the same method to test whether the voltage between the red, yellow, and black lines of the kneading counting board is normal. If there is no voltage, replace the kneading counting harness; If the voltage is normal, replace the kneading counting board. As shown in the figure on the right.



## 6. Massage machine tilts forward abnormal.

6.1 The massage machine tilts forward not work. Turn on the manual control to give the massage machine a forward tilt command, set the multimeter to the DC voltage range, and measure whether the voltage output at both ends of the connector at the forward tilt motor of the 14 roller board is normal. If there is no voltage, the roller board is broken, and it is normal after replacement. If the voltage is normal, check whether the connector between the roller board and the forward tilt motor harness is secure, and whether the terminals are in good contact. Then use a multimeter to measure the continuity of the 14 red and black wires on the roller board to the black three core 450B connector of the forward tilt motor harness. If they are all connected, it indicates that the forward motor is damaged and needs to be replaced. If it does not work, the forward tilt motor harness assembly needs to be replaced; The method for determining whether the forward motor is damaged is the same as the



method for determining the lifting motor in section 3.1.3.

6.2 The massage machine tilts forward improperly or exceeds its limit. It shows forward tilt counting malfunction. There are two types of this situation. One is a malfunction of the forward tilt counting board, which returned to normal after replacement (see 6.3). One is that the position of the "magnetic steel induction plastic part" in Figure 4 has changed. The solution is as follows: 1. As shown in Figure 6, ensure that the gear is fully meshed with the second tooth of the rack. If it is not fully engaged, adjust the forward tilt motor shaft until it is engaged. Align the plastic magnet with the lower Hall element and fix it.

6.3 Forward towards the top or bottom. Place the multimeter in the DC voltage range, use a magnet to approach and move away from the Hall element, and measure whether the voltage output between the brown, orange, and black wires of the connector at the forward limit of the roller board 4 is normal. If there is voltage, the roller board is damaged, and it is normal after replacement. If there is no voltage, check whether the wire harness between the roller board and the forward tilt limit board is connected normally. If it is connected normally, replace the forward tilt motor limit board; Otherwise, replace the forward tilt signal harness assembly.

### **7.If the whole machine is not inflated or one of the channels is not inflated, the massage mechanism is working normally**

7.1 If the whole machine is not inflated, use a multimeter in AC voltage range after starting up to measure whether there is a voltage of around AC24V at connector 7 of the main board. If there is, the air pump is broken. If there is no voltage output and the voltage at 4 points is normal, the main board is broken.

7.2 If above have no defects. Check if the main trachea or corresponding airway has fallen off.

7.3 If a certain circuit is not inflated, use a multimeter DC voltage range to measure whether there is a DC24V voltage output from the corresponding port of this circuit, or turn off the machine and use a multimeter ohm range to measure whether there is a resistance value of  $165 (\pm 10\%) \Omega$  for the corresponding solenoid valve of this circuit.

### **8.Back Actuator Abnormal Operation**

8.1 Electric actuator Does Not Operate. ① Set the multimeter to the DC Voltage Range, insert the two test leads into the terminals of the blue connector at the 20 back actuator, operate the backrest lifting button, and observe if the multimeter displays a DC24V output. If there is no voltage, the Main Board is faulty; replace it to restore normal operation.

② Check if the wiring harness between the 20 position and the mating connector of the actuator is firmly plugged in and if there is any terminal disengagement. Inspect the on-off status of the wiring harness; if broken, replace the corresponding Wiring Harness Assembly. Unplug the mating connector of the actuator and measure the resistance between the two wires of the actuator. If the actuator is at the upper or lower limit, use the Diode Range for forward and reverse testing—one-way conduction indicates the actuator is in good condition. At other positions, a resistance of 3-20Ω indicates it is normal; other cases prove that the electric actuator motor is faulty, and simply replace the electric actuator.

#### 8.2 Electric Actuator Fails to Stop at the Initial Massage Position.

① Set the multimeter to the DC Voltage Range, insert the two test leads between the green and gray wires of the connector at the 11 actuator counting signal, operate the backrest lifting button on the hand controller, and observe if the multimeter displays high and low level outputs. If there are high and low levels, the Main Board is faulty; replace it to restore normal operation. ② Check the on-off status of the wiring harness to the actuator and whether the connector is firmly plugged in. If normal, the actuator is faulty; replace it to restore normal operation. Otherwise, replace the corresponding wiring harness assembly.

### 9. Leg Actuator Not Moving

9.1 Electric Actuator Does Not Operate. ① Set the multimeter to the DC Voltage Range, insert the two test leads into the terminals of the green connector at the 19 leg Actuator, operate the backrest lifting or leg lifting button on the hand controller, and observe if the multimeter displays a DC24V output. If there is no voltage, the Main Board is faulty; replace it to restore normal operation. ② Check if the wiring harness between the 19th position and the mating connector of the actuator is firmly plugged in and if there is any terminal disengagement. Inspect the on-off status of the wiring harness; if broken, replace the corresponding Wiring Harness Assembly. Unplug the mating connector of the actuator and measure the resistance between the two wires of the actuator. If the actuator is at the upper or lower limit, use the Diode Range for forward and reverse testing—one-way conduction indicates the actuator is in good condition. At other positions, a resistance of 3-20Ω indicates it is normal; other cases prove that the electric actuator motor is faulty, and simply replace the electric actuator.

9.2 Electric Actuator Fails to Stop at the Initial Massage Position. ① Set

the multimeter to the DC Voltage Range, insert the two test leads between the yellow and black wires of the connector at the 11th Actuator counting signal, operate the backrest lifting button on the hand controller, and observe if the multimeter displays high and low level outputs. If there are high and low levels, the Main Board is faulty; replace it to restore normal operation. ② Check the on-off status of the wiring harness to the Actuator and whether the connector is firmly plugged in. If normal, the Actuator is faulty; replace it to restore normal operation. Otherwise, replace the corresponding Wiring Harness Assembly.

## 10. Remote Screen Abnormality, But Button Operation Function Is Normal

10.1 Abnormal Screen Display. Press and hold the Power On/Off Button to restart, then observe if it returns to normal. If not, replace the remote assembly.

## 11. Foot Roller Not Working

11.1 Activate the Foot Roller Function (Leg and Foot Air Pressure). If it does not work, set the multimeter to the DC Voltage Range, insert the two test leads into the terminals of the Roller Motor Connector at photo 1, and check if the output voltage is normal. If there is no voltage, the Leg Foot Board is faulty. If there is voltage output, use the multimeter to measure whether the voltage between the red and black wires of the 450 Connector at the other end of this Wiring Harness is 24V. If there is no voltage, replace this Wiring Harness Assembly; otherwise, the Roller Motor is faulty, and need to be replaced.

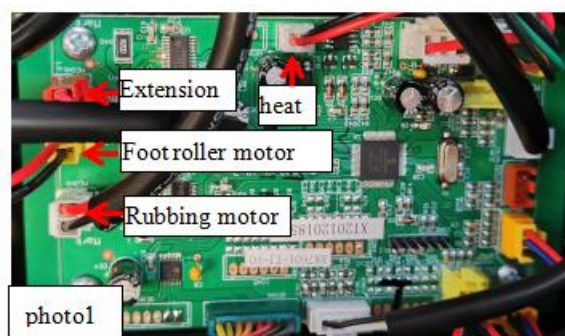

## 12. Leg Rubbing Motor Not Working

12.1 Activate the Leg Roller Function (Leg and Foot Air Pressure). If it does not work, set the multimeter to the DC Voltage Range, insert the two test leads into the terminals of the Leg Rubbing Motor Connector at Figure 1, and check if the output voltage is normal. If there is no voltage, the Leg Foot Board is faulty. If there is voltage output, use the

multimeter to measure whether the voltage between the brown and blue wires of the 450 Connector at the other end of this Wiring Harness is 24V. If there is no voltage, replace this Wiring Harness Assembly; otherwise, the Leg Rubbing Motor is faulty and need to be replaced.

### **13. Telescopic Motor Operation Abnormality**

#### 13.1 Telescopic Motor Does Not Work

13.1.1 Check if the Motor Connector is firmly plugged in, whether the mating connector is securely connected, and if the terminals are loose or disconnected.

13.1.2 Set the multimeter to the DC Voltage Range, insert the two test leads into the terminals of the Telescopic Motor Connector at Figure 1, operate the leg telescopic button on the Hand Controller, and observe if the multimeter displays a DC24V output. If there is no output, the Leg Foot Board is faulty; replace it to restore normal operation. Unplug the mating Telescopic Wiring Harness and measure if there is DC24V output. If not, the Telescopic Wiring Harness is damaged; simply replace it.

13.1.3 Measure the resistance between the two wires of the Telescopic Motor (normal range: 5-30 Ohms). No resistance or extremely high resistance indicates a motor fault; replace the motor.

13.1.4 Set the multimeter to the DC Range, measure the voltage between the green, yellow, white wires and the black wire of the telescopic counting signal Wiring Harness at CON2 of the Leg Foot Board. Block the Photoelectric Switch of the Counting Board one by one and check for voltage changes. If there are voltage changes, replace the Leg Foot Board. Check if the connecting Wiring Harness is conducting. If not, replace it; otherwise, replace the Counting Board.

13.2 When the device is turned on, the leg and foot section extends. Check if the Foot Detection Board is damaged. If the indicator light stays on, replace the Foot Detection Board. Use the multimeter's Buzzer Range to measure the on-off status of the red, blue, and black wires of the left and right leg length detection Wiring Harness. If the Wiring Harness is disconnected, replace it. Set the multimeter to the DC Range and measure the voltage between the blue and black wires of the orange connector. Press the sole of the foot by hand; if there is a voltage change, the leg and foot section is faulty; replace it. Otherwise, replace the Foot Detection Board.

13.3 The leg section does not extend. After checking according to 13.1, set the multimeter to the DC Range and measure if there is a voltage change between the blue and black wires of SCON4. If not, replace the Ground Detection Assembly; otherwise, replace the Leg Foot Board.

13.4 The leg section does not retract. After checking according to 13.1, check if the Anti-Pinch Detection Board is damaged. If the indicator light stays on, replace the Anti-Pinch Detection Board. Use the multimeter's Buzzer Range to measure the on-off status of the red, blue, and black wires of the Anti-Pinch Wiring Harness. If the Wiring Harness is disconnected, replace it. Set the multimeter to the DC Range and measure if there is a voltage change between the blue and black wires of SCON5 and SCON6. If not, replace the Anti-Pinch Detection Board Assembly; otherwise, replace the Leg Foot Board.

#### **14. Knee Heating Pad Not Working**

14.1 Turn on the Heating Function and measure whether the voltage at the heating position in Figure 1 is DC24V. If there is no voltage output, the Leg and Foot Panel is damaged. If there is voltage output, use a multimeter to measure whether the Heating Wire connector has DC24V. If not, replace the Heating Wire. If there is voltage, replace the Heating Pad.

#### **15. Shawl Heating Pad Not Working**

15.1 Check whether the connector at Position 29 is firmly plugged in and whether the terminals are loose. Check whether the DC plug of the Seat Heating Wiring Harness is firmly connected; check whether the internal heating wire of the Back Cushion is securely fastened.

15.2 Turn on the Heating Function, set the multimeter to the DC Voltage Range, insert the two test leads into the terminals of the blue connector at the 19 Shawl Heating Position\*\*, and measure whether the voltage is DC24V. If there is no voltage output, the Mainboard is damaged and needs to be replaced. Measure whether there is DC24V output at the DC connector of the Seat Heating Wire; if there is no voltage output, the Heating Wiring Harness is faulty. Measure whether there is 24V output at the DC connector of the Shawl Heating Extension Wire inside the Back Cushion; if there is no voltage output, the Heating Extension Wire is damaged and needs to be replaced. If there is voltage output in all the above measurements, the Heating Pad is damaged and needs to be replaced.

#### **16. Speaker No Sound or Abnormal Voice**

16.1 Speaker No Sound. Connect a mobile phone via Bluetooth and play music. Measure the voltage at Connector 21 to see if it is DC12V. If there is no voltage output, the Mainboard is damaged. Check if there is voltage at J1 of the Voice Board; if not, replace the Wiring Harness. If there is voltage output, use a multimeter to measure whether there is voltage at J2 and J3 of the Power Amplifier Board; if not, replace the Power

Amplifier Board. If there is voltage, check that the Wiring Harness is in good condition, then replace the Speaker.

16.2 If no issues are found in the check according to 16.1, inspect whether the connector is firmly plugged in. If it is normal, replace the Microphone Assembly.

### **17. Anion Function Not Working**

17.1 Turn on the Anion Function. Measure the voltage at the 24 Anion Connector to check if it is DC12V. If there is no voltage output, the Mainboard is damaged. Check whether there is voltage between the Shoulder Connectors; if not, replace the Wiring Harness. If there is voltage output, replace the Anion-related Components.

### **18. Charging Abnormality**

18.1 Wireless Charging Abnormality. ① Use the DC Voltage Range of a multimeter to measure whether there is DC24V output between the brown and blue wires of the 5 Output (DC24V). If there is no voltage output, replace the Rectifier Board. ② Measure whether there is DC24V input voltage at the Armrest Charging Board. If not, check whether all connectors between the Armrest Charging Board and the Mainboard are firmly plugged in and whether the Wiring Harness is unobstructed. If the Wiring Harness is disconnected, replace the corresponding Wiring Harness. ③ Measure whether there is DC24V output at the \*\*3.96 Connector\*\* of the Charging Board. If not, replace the Charging Board. Measure whether there is DC24V input at the Wireless Charging Board. If not, replace the Connecting Wiring Harness. Otherwise, replace the Wireless Charging Board.

18.2 USB Charging Abnormality. Use the DC Voltage Range of a multimeter to measure whether there is DC5V output between the red and black wires at both ends of the red connector of the Charging Board output. If not, replace the Charging Board. Check whether the USB Wiring Harness is unobstructed. If it is disconnected, replace the Wiring Harness; otherwise, replace the USB Board.

### **19. LED Light Board and LED Strip Abnormality**

19.1 Check whether the connectors between the Mainboard and the LED Light Board are firmly plugged in and the on-off status of the Wiring Harness. If the Wiring Harness is disconnected, replace the corresponding LED Light Board Wiring Harness Assembly.

19.2 Turn on the Tablet. Use the DC Voltage Range of a multimeter to measure whether there is DC24V voltage output at the left and right Light Board Connectors (Position 31) of the Mainboard. If there is no voltage output, replace the Mainboard Assembly.

19.3 Open the Armrest. Use the DC Voltage Range of a multimeter to measure whether there is DC24V voltage at both ends of the Light Board Connector. If there is voltage, replace the LED Light Board.

Follow this sequence to detect LED Strip faults, with the required voltage being DC12V.

## **20. Shoulder Height Detection Abnormality**

20.1 During Shoulder Height Detection, the Lifting Motor stops as soon as it moves downward after reaching the top of the backrest. This phenomenon is caused by excessive or fluctuating current of the Lifting Motor. Connect the DC Current Range of a multimeter in series to the control circuit of the Lifting Motor (or clamp the red or black electronic wire with a clamp meter) to measure whether the no-load current of the Lifting Motor is between DC0.3-0.45A. If the current is too high (above DC0.6A), replace the Lifting Motor; otherwise, replace the Movement Board.

20.2 During Shoulder Height Detection, the Movement stops near the waist area. This phenomenon is caused by insufficient current of the Lifting Motor. Measure the current according to the steps in 20.1. If the current is low when the shoulder press is activated, replace the Lifting Motor; otherwise, replace the Movement Board.

## **21. Mech Heating Abnormality**

21.1 Check if the Connectors are loose or disconnected. Use the Resistance Range of a multimeter to measure the resistance of the \*\*45 Left Upper Wheel Signal Sensor\*\* and \*\*46 Right Upper Wheel Signal Sensor\*\*. The normal resistance is around 10K $\Omega$  (at 25 $^{\circ}$ C). If there is no resistance (or extremely high resistance) or extremely low resistance, replace the corresponding Temperature Sensor.

21.2 If the sensors are normal, turn on the power and activate the heating function. If there is no DC24V output from the heating output of the Mech Board, it indicates a fault in the sensor detection circuit of the Mech Board; simply replace the Mech Board.

21.3 Turn on the power and activate the heating function. Use a multimeter to measure whether there is DC24V voltage output at the 43 Left Upper Wheel Heating Connector and 44 Right Upper Wheel Heating Connector. If there is no voltage output, replace the Mech Board.

21.4 Use the resistance range of a multimeter to measure the resistance values of the heating elements of Heating Unit 43 (Upper Left Wheel) and Heating Unit 44 (Upper Right Wheel). Replace the corresponding heating element if an open circuit is detected.

### III Mechanical Faults and Solutions

#### 1. Replace the Massage Mech

1.1 As shown in Figure 1, use a Phillips Screwdriver to remove 4 pieces of ST4.2\*16 Screws and take off the Backrest Rear Shield.

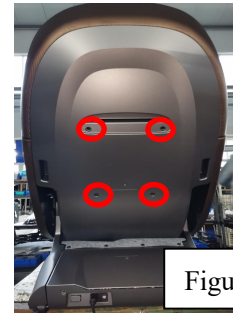

Figure 1

1.2 As shown in Figure 2, use a Phillips Screwdriver to remove 6 pieces of 4\*10 Phillips S-Type Head Self-Tapping Screws.

1.3 Pull out the mechanism Wiring Harness Connector, then disassemble and remove the Mechanism Assembly.

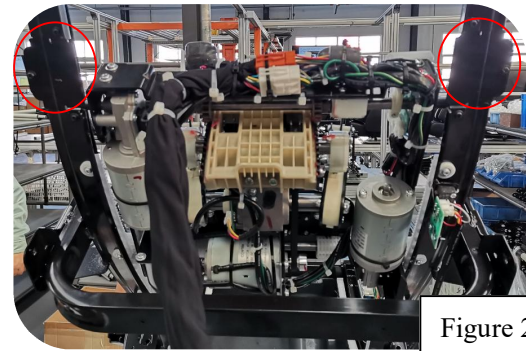

Figure 2

#### 2. Remove the Armrest Assembly and Shoulder Assembly

2.1 Remove the Armrest Assembly

2.1.1 As shown in Figures 1, 2, and 3, first remove the M6\*16 Phillips Pan Head Screws, then pull out the connecting parts and air tube between the Armrest and the Main Unit, and detach the Armrest.



Figure 1

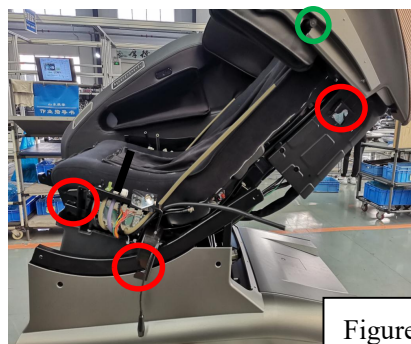

Figure 2



Figure 3

2.1.2 Remove the armrest

2.1.2.1 As shown in the figure, use a tool to remove the 18 screws on the Armrest Plastic Body and disassemble the Armrest Inner and Outer Casings.

2.1.3 Remove the Armrest Arm Airbag

2.1.3.1 Use a tool to remove the 2 screws, pull out the air tube of the Armrest Arm Airbag, and disassemble the Arm Airbag.



**2.2 Remove the Shoulder Assembly**  
 As shown in the figure, remove the 6 screws above the Shoulder Assembly, then pull out the connected Air Tube, and replace the Shoulder Assembly.

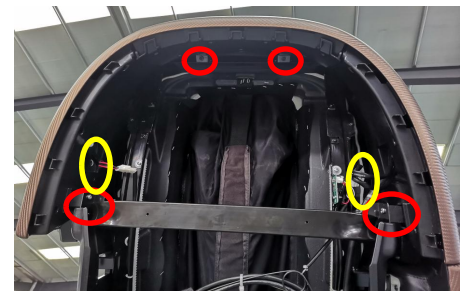

**2.2.1 Remove the Shoulder Speaker**

As shown in the figure below, pry off the Speaker Cover from the edge forcefully, then remove the 2 screws securing the Speaker Housing, and replace the Speaker.

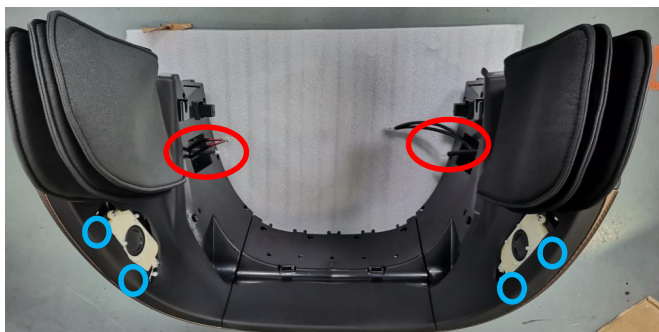

**2.2.2 Remove the Shoulder Airbag**

As shown in the figure, first remove the screws under the Shoulder Airbag, then pull out the air tube connected to the Airbag, and replace the Shoulder Airbag.



### 2.2.3 Remove the Shoulder Inner and Outer Casings

As shown in the figure, after removing the 6 screws under the Shoulder Airbag, then remove the 26 screws on the Shoulder Assembly at the positions shown in the figure, disassemble the Shoulder Inner and Outer Casings, and replace the internal wiring harness and components.

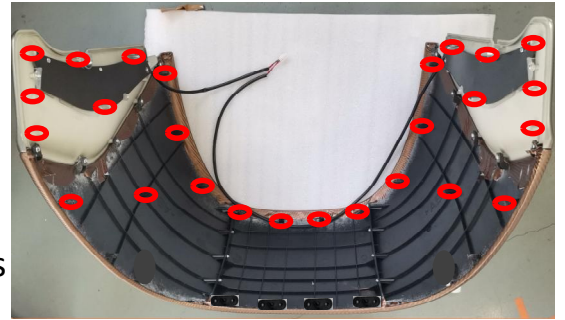

### 3. Remove the Front Backrest Plastic Body Assembly.

As shown in the figure, after removing the Rear Shield, remove the screws on both sides at the indicated positions, and remove the 2 screws at the front end, and replace the Front Backrest Plastic Body Assembly.



### 4. Remove the Power Box Assembly.

4.1 As shown in the figure, remove the 2 screws at the positions shown in the figure, then take off the Power Box Upper Cover and replace the internal components.

4.2 As shown in the figure, remove the screws at the positions shown in the figure inside the Power Box, then pull out the wiring harness connector, and replace the Power Box Assembly.

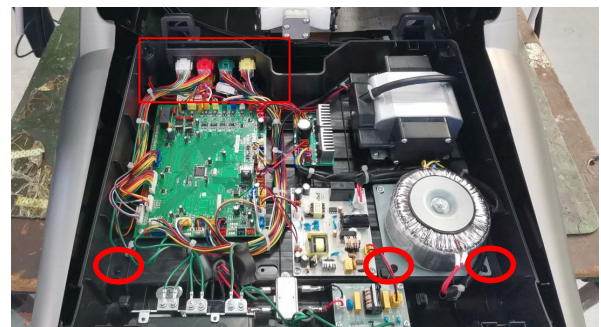

## 5. Remove the Leg and Foot

As shown in the figure on the right, use a tool to remove the 2 screws connecting the leg and foot, lift the leg and



foot, then pull out the air tube and wiring harness connector, and replace the Leg and Foot Assembly.

### 5.1 Remove the Foot Assembly

5.1.1 As shown in the figure below, use a tool to remove the screws at the positions shown in the figure, then take off the Leg and Foot Rear Shield, replace the Shield Component and repair the internal structure.

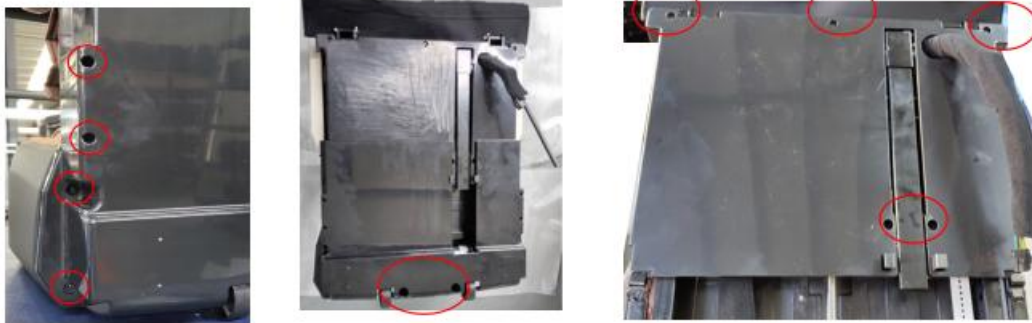

### 5.2 Replace the Foot Assembly and Solenoid Valve.

5.2.1 As shown in the figure below, first use a screwdriver to remove the screws shown in the figure, then pull out the wiring harness and air tube in sequence, and replace the Foot Assembly and Solenoid Valve Assembly.

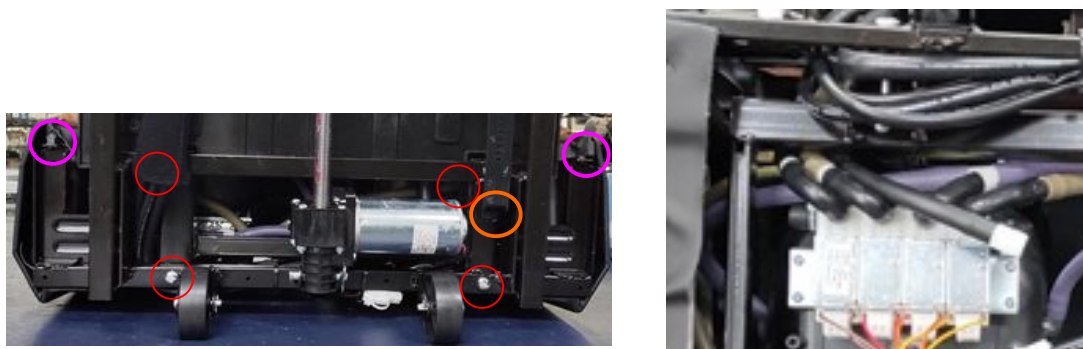

### 5.3 Replace the Leg and Foot Telescopic Support Rod.

5.3.1 As shown in the figure, use a tool to remove the 2 hexagon socket M6\*12 screws in the figure, then remove the cotter pin + B8\*40 pin shaft, pull out the connecting wiring harness connector, and replace the Leg and Foot Telescopic actuator.

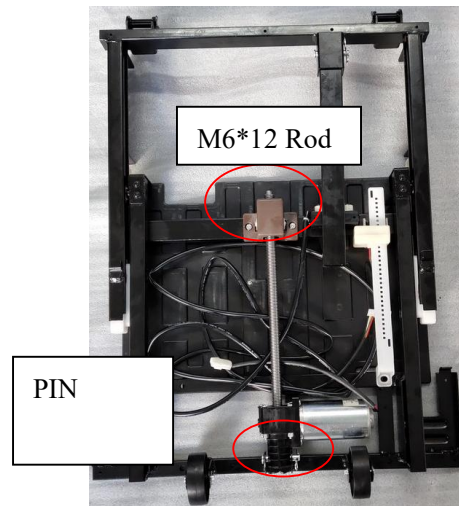

### 5.4 Remove the Leg Frame.

5.4.1 As shown in the figure below, first unzip the zipper of the seam product, then remove the Airbag, take the Airbag out of the seam product cover, then remove the screws at the positions shown in the figure, and replace the Leg Frame and Leg Massage Assembly.



5.4.2 Remove the Leg Motor  
Remove the screws and connectors at the positions shown in the figure, then replace the Leg Massage Motor.

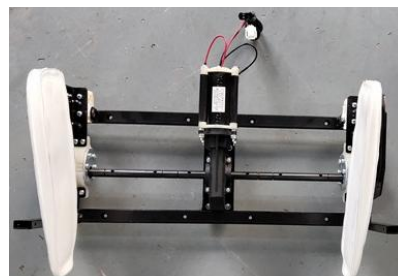

5.5 Remove the Foot Roller  
 As shown in the figure, use a tool to remove the screws in the figure, pull out the wiring harness connector, then remove the Foot Massage Assembly, and replace the Foot Roller.



5.6 Remove the Foot Circuit Board and Solenoid Valve  
 As shown in the figure, remove the 4 screws on the circuit board and replace the Circuit Board; remove the 4 screws of the solenoid valve and replace the Solenoid Valve Assembly.



5.7 Replace the Foot Anti-Pinch Device.

According to the positions shown in the figure, remove the Foot Upper and Lower Casings first, then take out and replace the Foot Anti-Pinch Detection board.

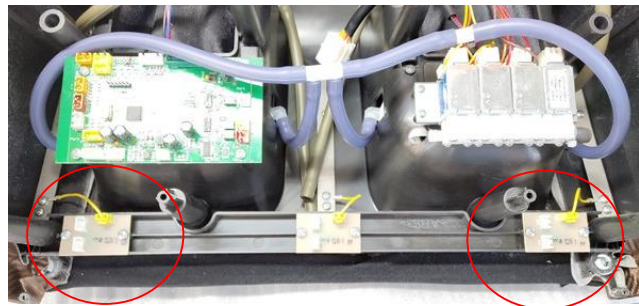
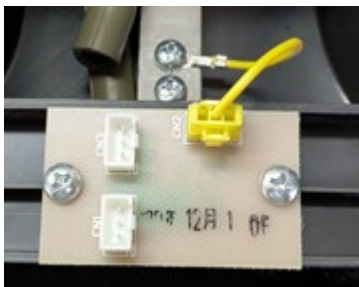

5.8 Replace the Foot Massage Unit.

As shown in the figure, remove the screws at each indicated position and replace the Foot Massage Unit Assembly.

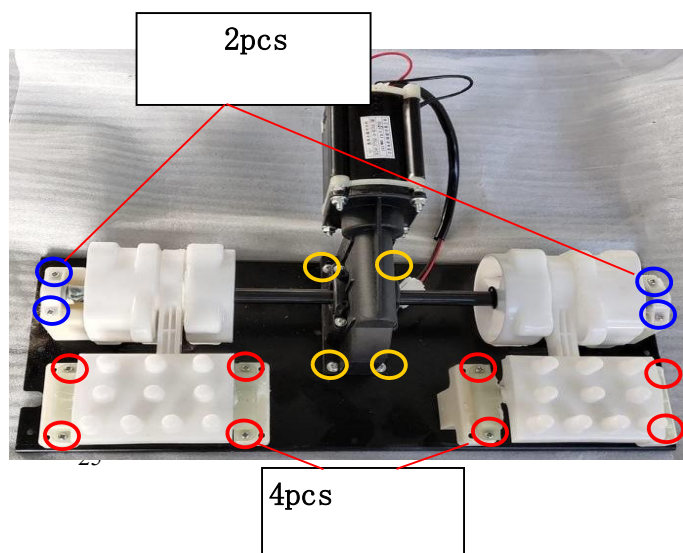

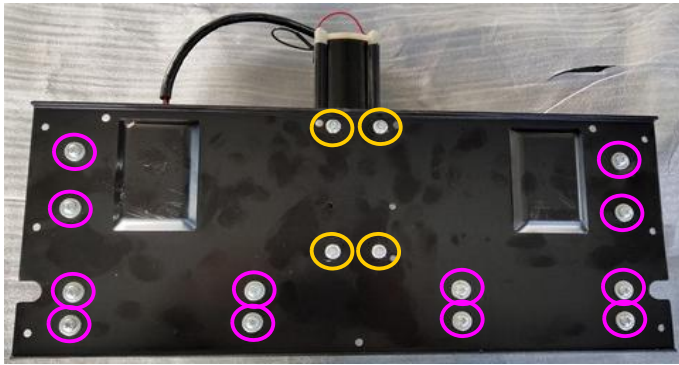

### 5.9 Replace Foot Detection board

As shown in the figure, first remove the Foot Cover, then take out the 2 fixing screws of the Foot Base Gasket, and finally replace the Foot Detection board.



## IV. System Connection Diagram

### Main PCB

