

ROTAI

荣泰



**ROTAI S80 Massage Chair
Maintenance Manual**

Shanghai Rongtai Health Technology Co., Ltd.



S80 Parameters

Product Parameters

Picture		Specifications	
		Model	S80
		Rated Voltage	220V~
		Power Consumption	160W
		Upright Size	(1680*775*1190mm)
		Reclined Size	(1865*775*1050mm)
		Package Dimension	Chair body: 1370*860*1290mm
			Footrest: 515*545*620mm
		Loading Qty	42PCS/40HC
		N.W.	120KG
		G.W.	143KG
Neck Mechanism	No	Music	<input checked="" type="checkbox"/> Yes <input type="checkbox"/> No
Back Mechanism	58C# Pressure sensitive mechanism	Bluetooth	<input checked="" type="checkbox"/> Yes <input type="checkbox"/> No
Shoulder Scan	<input checked="" type="checkbox"/> Yes Hall sensing <input type="checkbox"/> No	Heating	<input checked="" type="checkbox"/> Back cushion (Carbon fiber) <input type="checkbox"/> leg <input checked="" type="checkbox"/> foot
Mechanism Width Coverage	Kneading width ranges 4~15.5cm, Mechanism travel length reaches 820mm (to thigh)	Ambient Light	<input checked="" type="checkbox"/> Yes <input type="checkbox"/> No
Track	L-style track/travel length reaches 820mm	Sync music	<input checked="" type="checkbox"/> Yes <input type="checkbox"/> No

S80 Parameters

Forward Sliding	Recline while sliding	Controller memory function	<input checked="" type="checkbox"/> Yes <input type="checkbox"/> No
Shoulder Width	580mm	Controller memory function	<input checked="" type="checkbox"/> Yes <input type="checkbox"/> No
Seat Width	510mm	Voice Control	Offline voice control
Backrest Recline	Reclining by 130-155°	Charging for Mobiles	<input checked="" type="checkbox"/> Yes/power 5 V 2 A
Product Reclined Size	1865mm	Program Version	
Controller	Tablet controller	Auto massage	28 Auto Massage Programs: Chair Yoga,Slim Massage,High Heels,Womb Care,Sports Refresh,CEO Comfort,Tummy Care,Deep Release,Refreshing Nap,Extension,Energy Restore,Immune Boost,Growth Promotion,Intelligence Growth,Sports Refresh,Exams Relaxation, Brainwave Massage,Mindfulness Meditation,Breathing Improvement,Soul Trip,Binge Watching,Sweet Dreams,Long Sitting,Fatigue Recovery,Sore Relief,Neck & Shoulder,Back & Spine,Waist & Hip
Controller Organizer	<input type="checkbox"/> Pouch <input checked="" type="checkbox"/> Slot organizer		
Phone Stand	<input type="checkbox"/> Yes <input checked="" type="checkbox"/> No		
Foot Extension	<input checked="" type="checkbox"/> Electric <input type="checkbox"/> Spring		
	Legrest auto extension by 70mm Footrest auto extension by 180mm		
Foot Roller	<input type="checkbox"/> one row <input checked="" type="checkbox"/> 2 rows <input type="checkbox"/> 3 rows		
Airbags	Shoulder: 4PCS, 1PCS at each side (2 layer)	Manual massage	15 Massage Techniques: Kneading (Clockwise Kneading, Lightly Kneading, Interval Kneading) , Sync (Clockwise, Circular, Interval) ; Tapping (Continuous, Rhythmic, Variable-frequency) , Shiatsu (Regular,Tui Na,bone cracking) Knocking (Short, Medium, Long)
	Arm: 24PCS, 12PCS at each side (2 layer)		
	Hips: 4PCS, 1PCS at each side (2 layer)		
	Legs: 20PCS (2 layer)		
	Feet: 12PCS, 4PCS at foot side (2 layer) , 4PCS at heel (single layer)	Part: Whole,partial,point Width: wide,medium,narrow	
Solenoid Valves	1 for seat,1 for shoulder,2 for armrest(a 3-way air valve at each side), Legrest: 2-way air valves, footrest: 2-way air valves, total 13 air valves	Configure List	Airbag QTY: 40PCS
Air compressor	Power box:2PCS YN250A/24V		Air Valve QTY: 13PCS
Leather	CXP series PU leather		Motor QTY: 7PCS
APP Control	<input checked="" type="checkbox"/> Yes <input type="checkbox"/> No		Air compressor: 2PCS
			Actuator: 2PCS

S80 How to Enter Engineering Mode



Click into
Settings



Click on
About

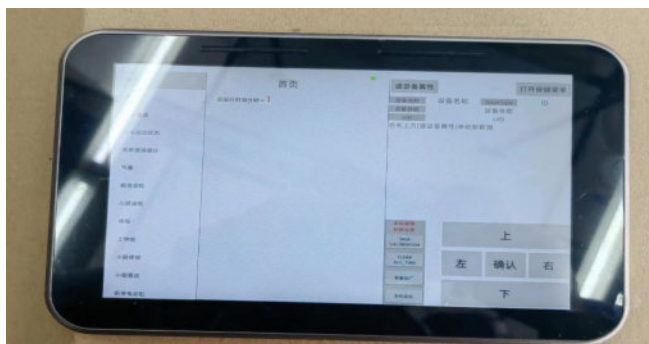

Engineering
Mode
Homepage

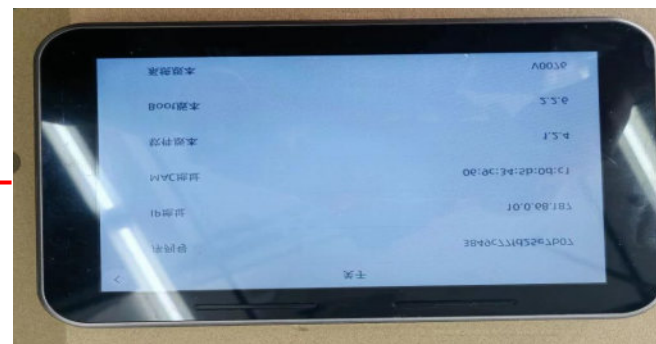

Select MAC address
and click 5 times to
enter Engineering
Mode

Troubleshooting Example



Click on Read Device Properties to obtain device information



Click on Current Errors; machine faults will display, 0 indicates normal function, 1 indicates a fault



Click on Open Keypad Menu to individually troubleshoot and repair faults

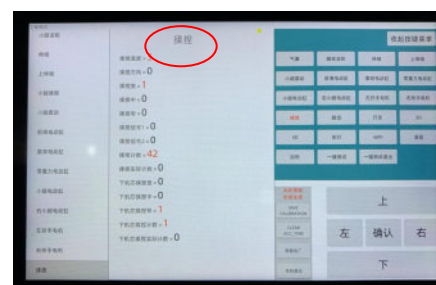

For example, with kneading motor: manually activate the kneading motor, count the rotations to confirm functionality; if there are changes in the width values, it indicates they are functioning well.



For example, with forward sliding actuator: changes in forward sliding speed indicate functionality; no changes indicate malfunction



Fig. 1

Pull open the marked red zipper as in Fig. 1



Fig. 2

Remove the marked blue buckle as in Fig. 2



Fig. 3

Unplug the marked purple component and air hose as in Fig. 3

Armrest Outer Cover Disassembly



Fig. 1

Remove the rear cover's marked red 4 screws, and take off the rear cover as in Fig. 1



Fig. 2

Pry open the upper cover from under the red marked buckle as in Fig. 2

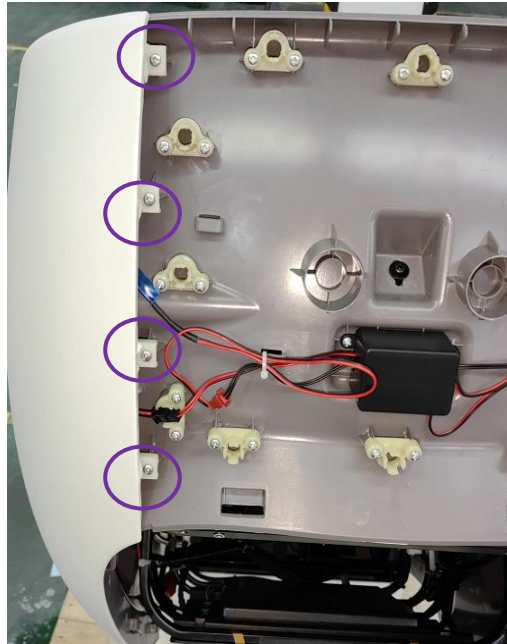

Fig. 3

Remove the upper inner cover's marked purple 4 screws as in Fig. 3



Fig. 4

Remove the 7 screws of the inner cover of the armrest marked with blue as in Fig. 4



Fig. 5

Remove the 2 screws at the front end of the armrest marked green as in Fig. 5 to remove the outer cover

Armrest Upper Inner Cover Disassembly

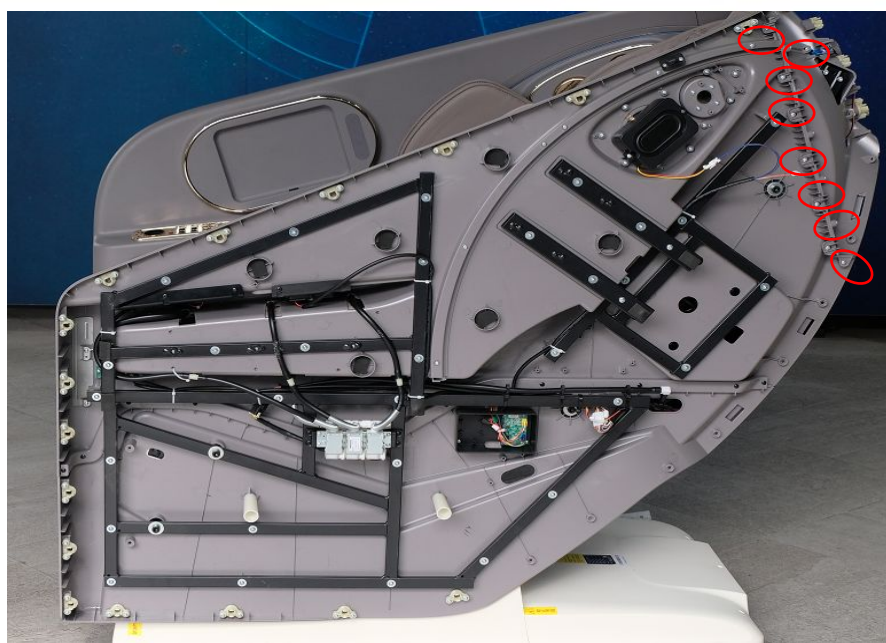

Fig. 1

Remove 14 screws each marked red on the left and right sides, and one in the middle; cut the blue tie, unplug the connector, remove the purple marked screw to remove the upper inner cover

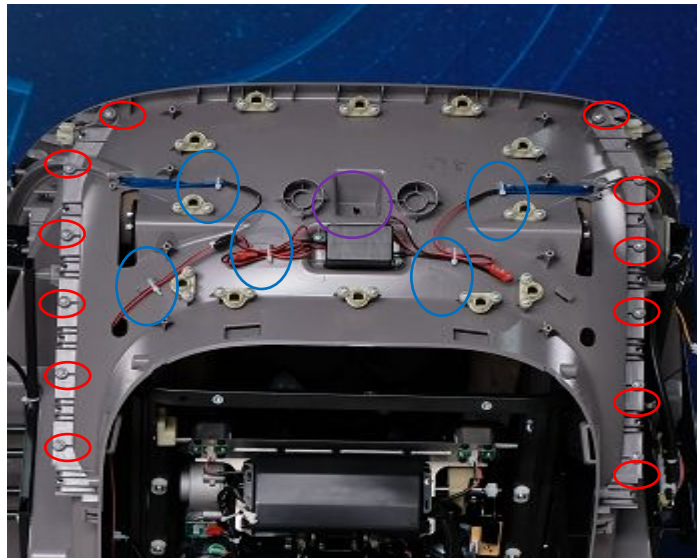

Fig.
3



Fig. 2



Fig. 1

Remove the red marked three screws on top of the rear footrest cover as in Fig. 1



Fig. 2

Remove the red marked two screws on top of the power box; slightly push forward the red marked buckle on the power box cover, then remove the cover as in Fig. 2

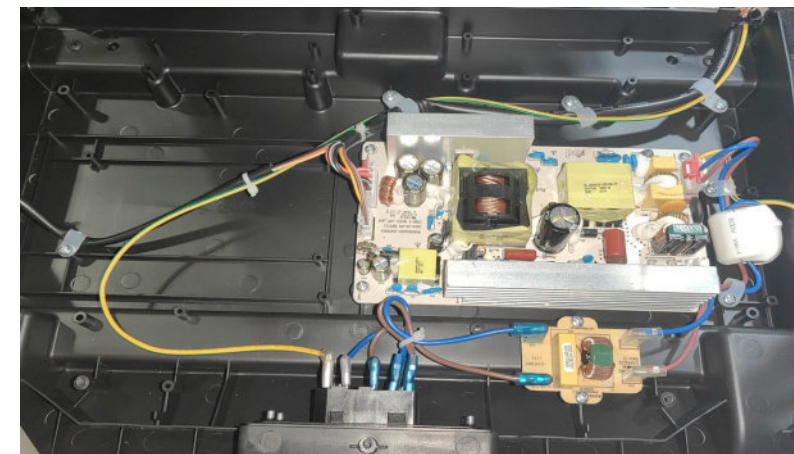

Fig. 3

Inside the power box are switch components, power board, filter board as in Fig. 3



Fig. 1

Remove the two screws outside of the footrest cover as in Fig. 1

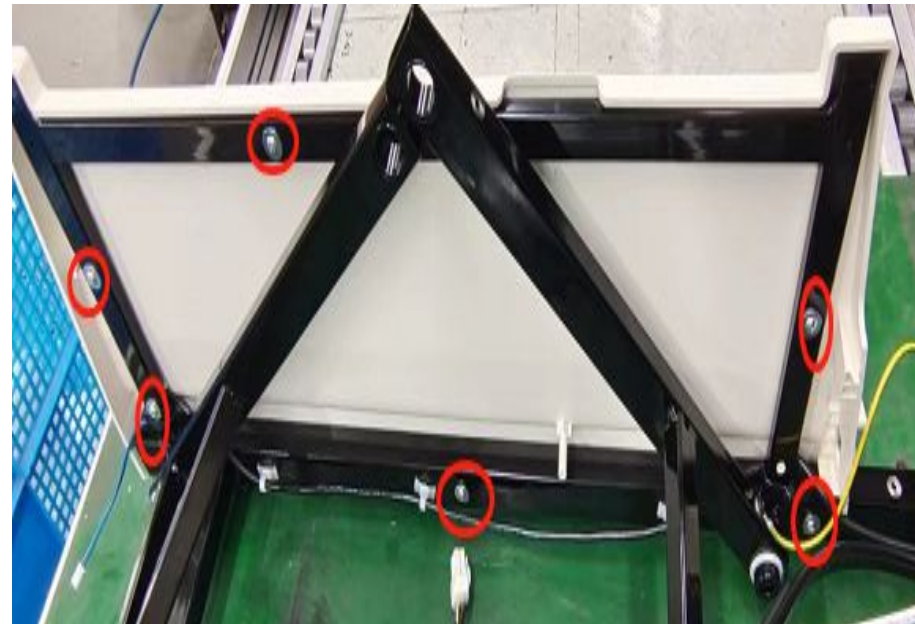

Fig. 2

Remove the six inner screws of the footrest cover; then, remove the footrest cover as in Fig. 2



Fig. 1

First, remove the upper cover's marked red 4 fixed screws as in Fig. 1

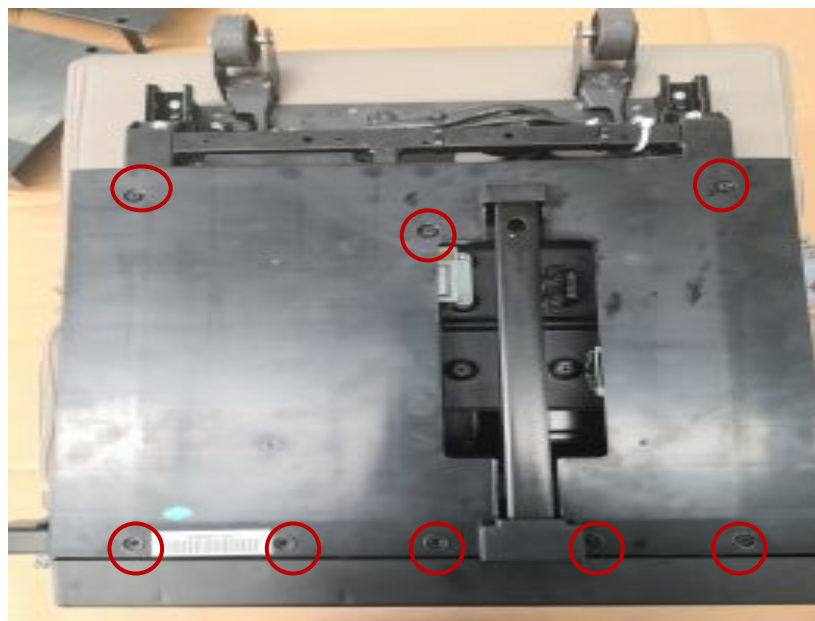

Fig. 2

Remove the lower cover's marked red 8 fixed screws as in Fig. 2

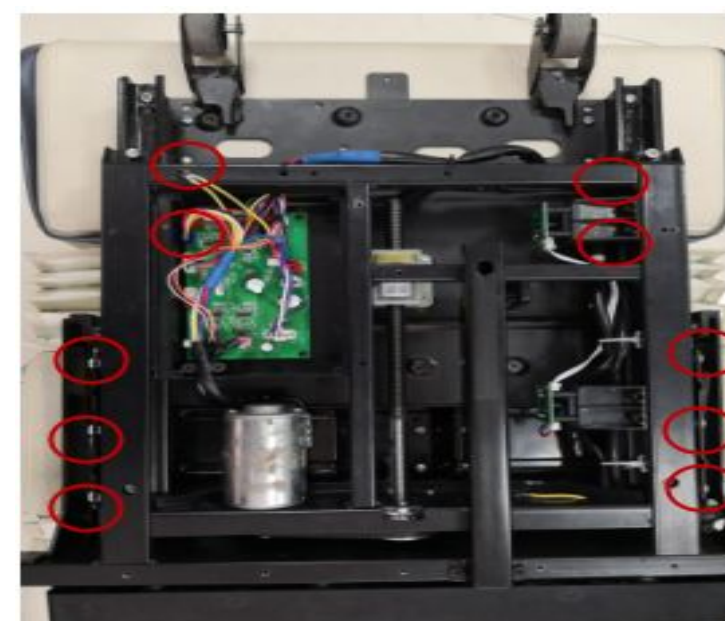

Fig. 3

First, remove 6 screws fixing the legrest extension unit, turn the extension belt, and remove the 4 fixed screws of the lower legrest as in Fig. 3

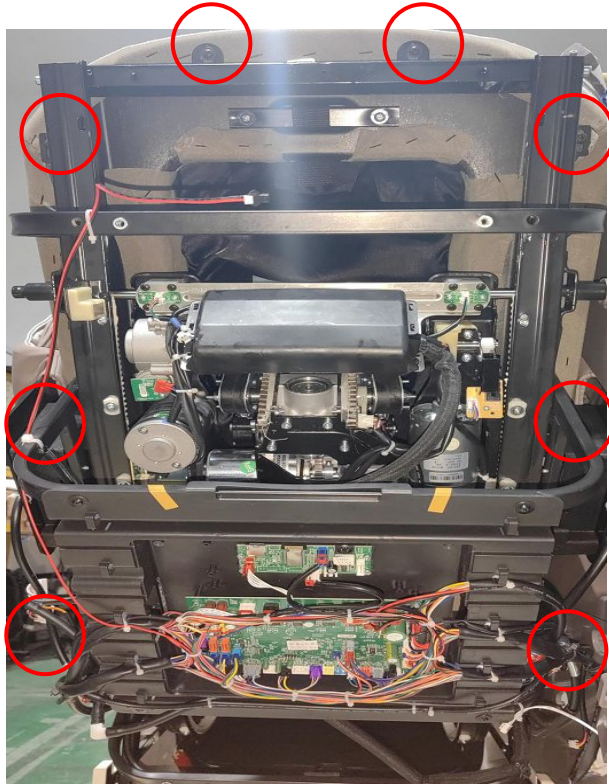

Fig. 1

Remove the 8 red-marked screws at the back of the backrest as shown in Fig. 1.



Fig. 2

Remove the 2 blue-marked screws at the front end of the backrest as shown in Fig. 2.



Fig. 1

Remove the 4 red-marked screws on both sides of the backrest crossbar clamp as shown in Fig. 1.



Fig. 2

Remove the magnet on top of the backrest frame as shown in Fig. 2.

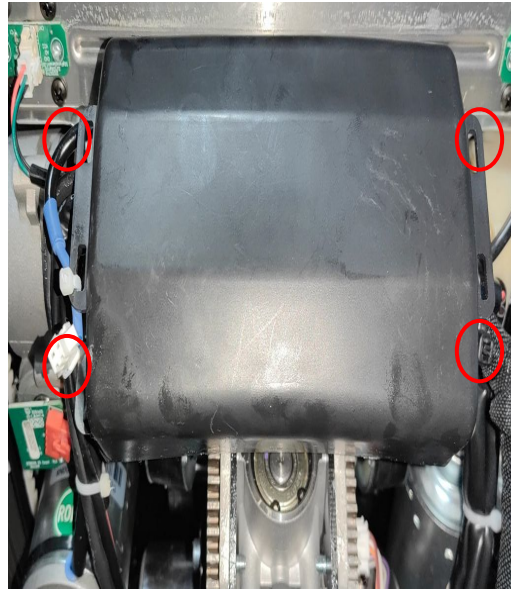

Fig. 3

Remove the 4 red-marked screws on the mechanism cover as shown in Fig. 3.

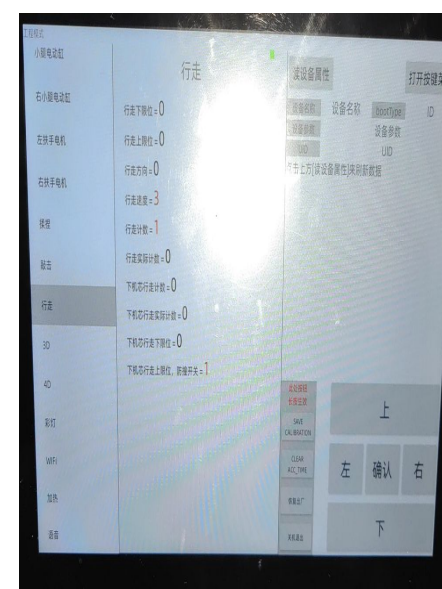

Fig. 4

Enter the engineering mode, navigate to the walking section, and move the mechanism upwards as shown in Fig. 4.

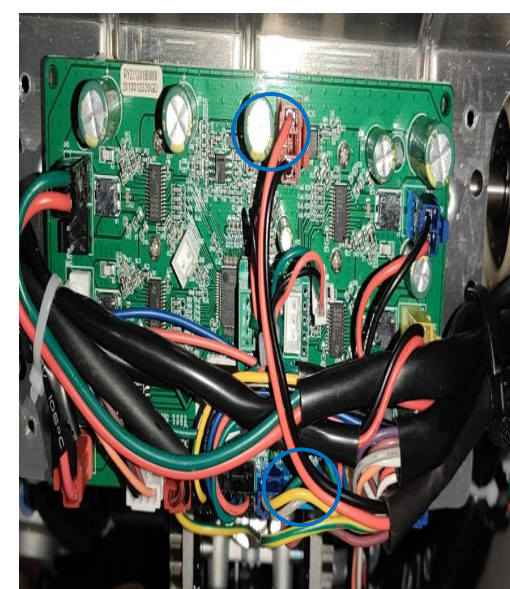

Fig. 5

Cut the zip ties, unplug the blue-marked connector, and remove the mechanism as shown in Fig. 5.

Armrest Button Pad Disassembly



Fig. 1

Peel off the two red-marked stickers as shown in Fig. 1.



Fig. 2

Remove the 4 red-marked screws as shown in Fig. 2.

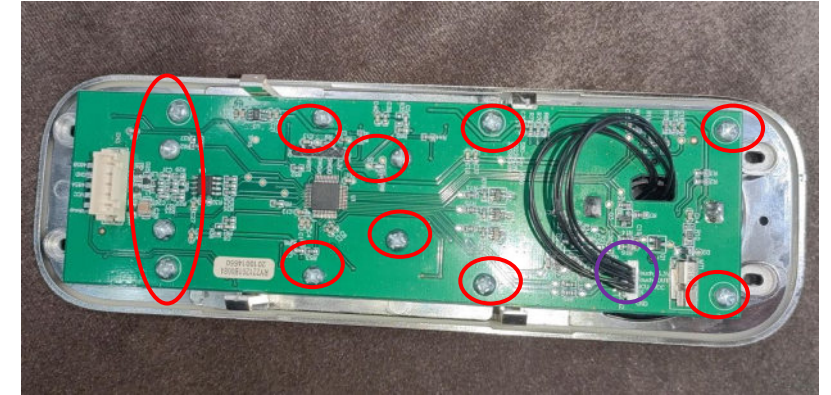

Fig. 3

Remove the 12 red-marked screws, unplug the purple-marked connector as shown in Fig. 3.

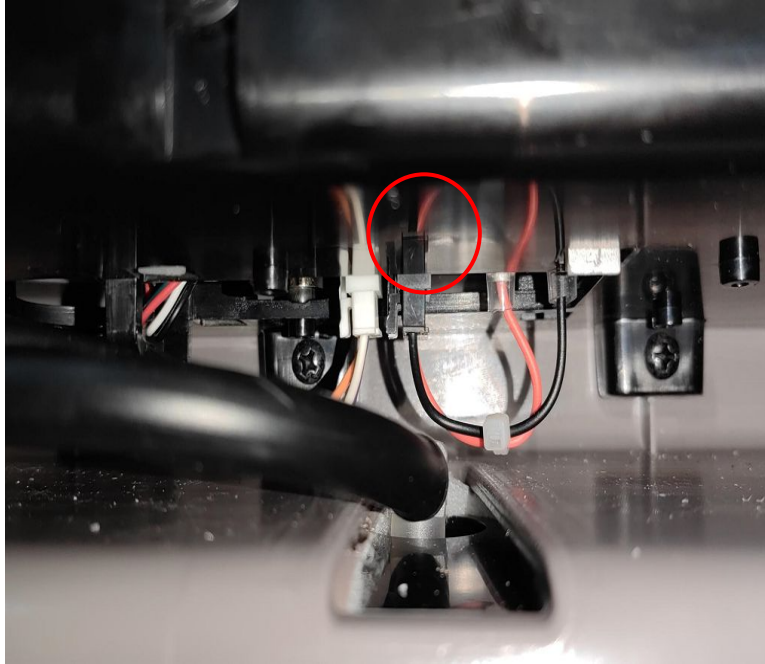

Fig. 1

In the state of the armrest outer cover removed, use a tool to push up the red-marked buckle as shown in Fig. 1.

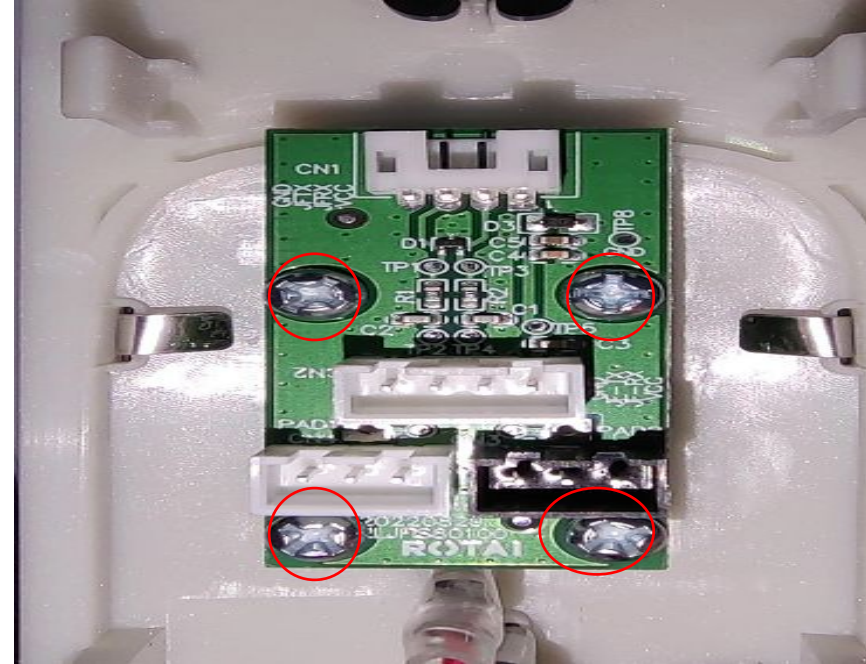

Fig. 2

Remove the 4 red-marked screws and unplug the connector as shown in Fig. 2.



Fig. 1

Remove the aroma container from the red-marked right speaker position as shown in Fig. 1.



Fig. 2



Fig. 3

Take out the aroma, find the corresponding number, and open the rubber pad to place it inside as shown in Fig. 2 and Fig. 3.

S80 mechanism board connectors

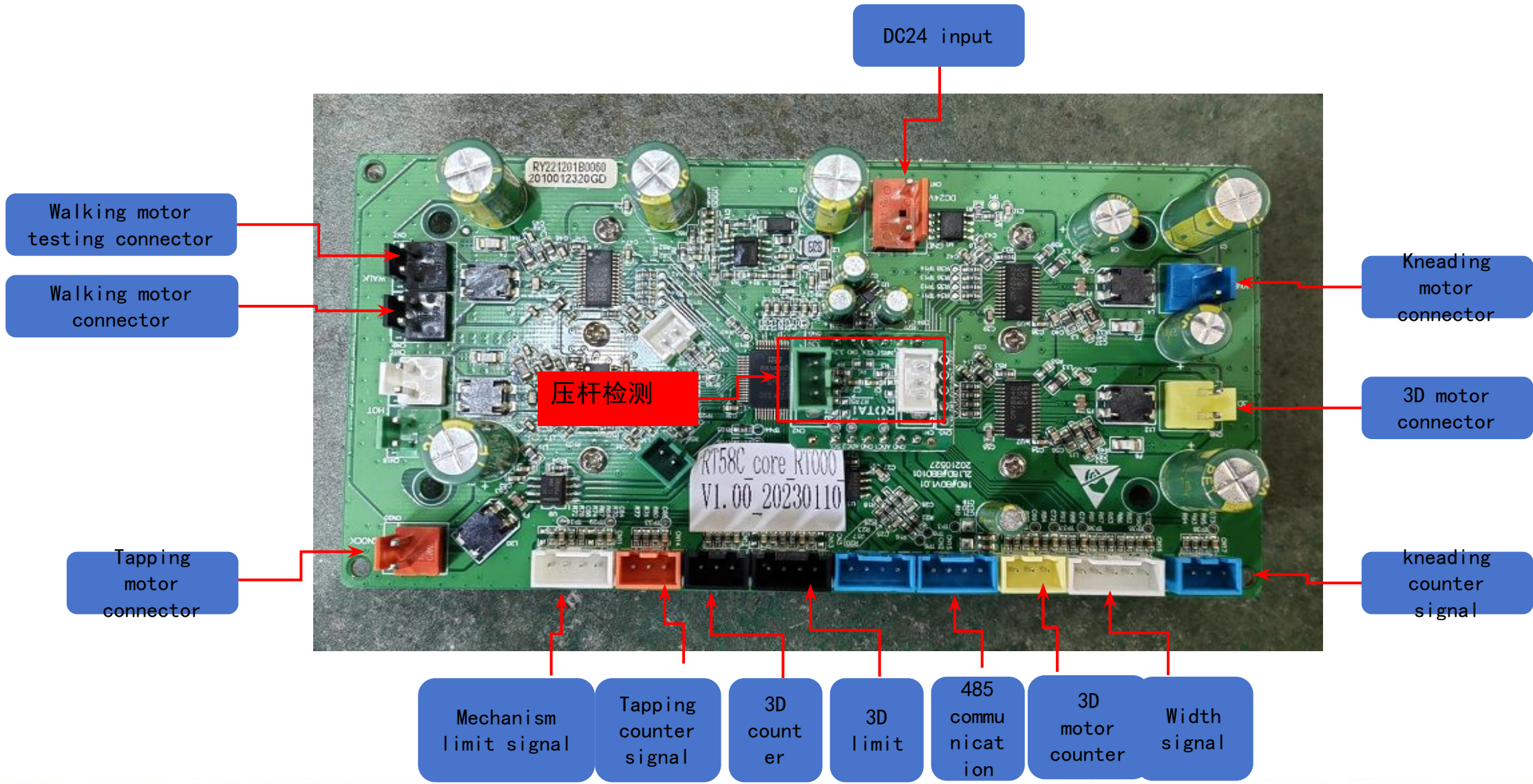

Bluetooth board, power board

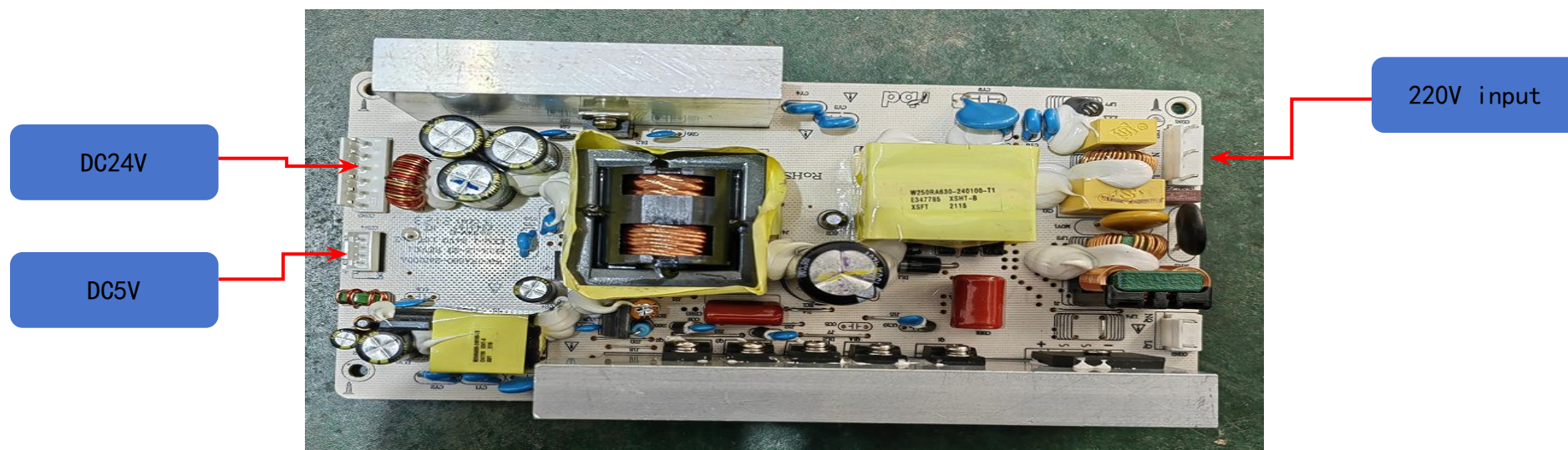
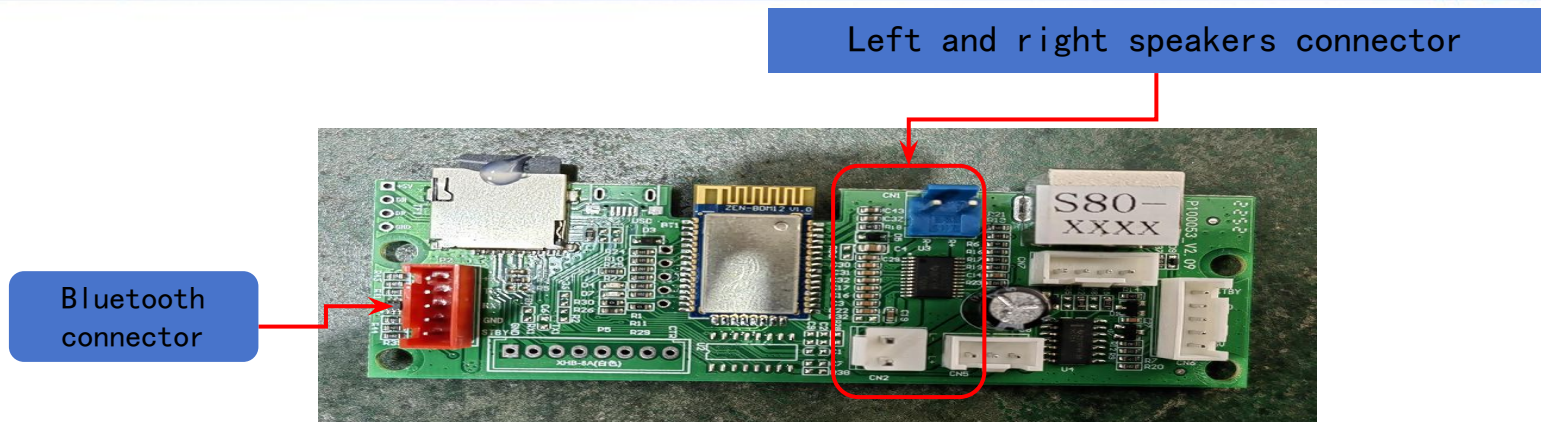

Width sensor board

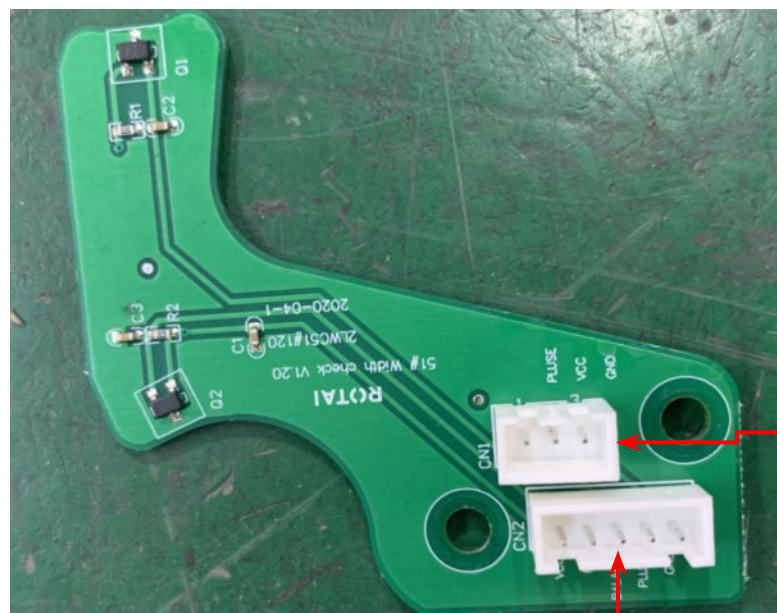

walking motor counter signal connector

mechanism width sensor board

S80 3D counter board, push rod sensor board, button pad, charging board

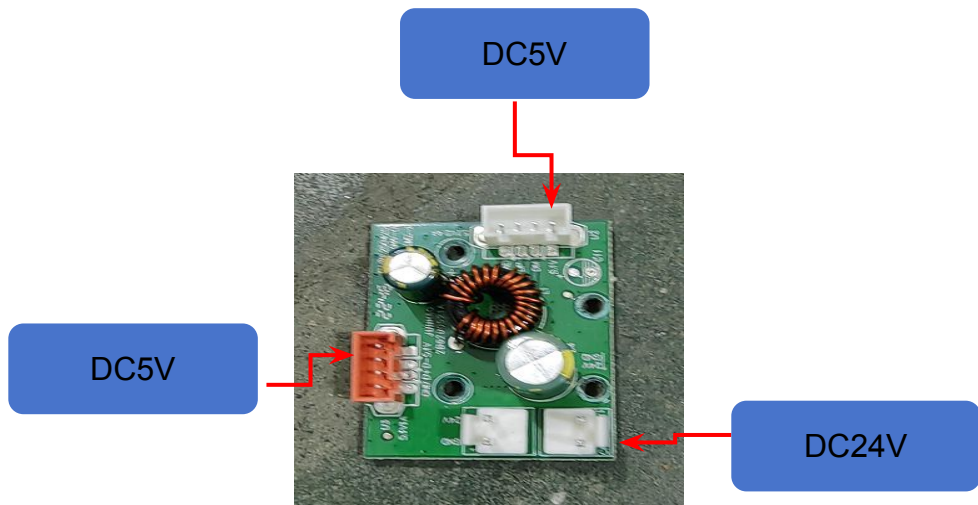

DC5V

DC5V

DC24V

charging board

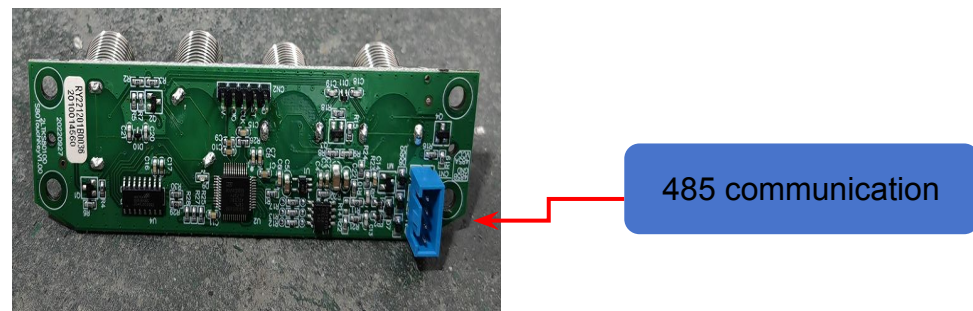

485 communication

button pad

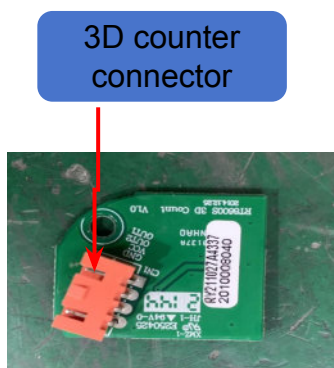

3D counter connector

3D counter board

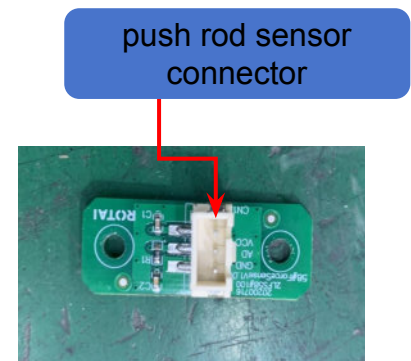

push rod sensor connector

push rod sensor board

S80 upper legrest drive board

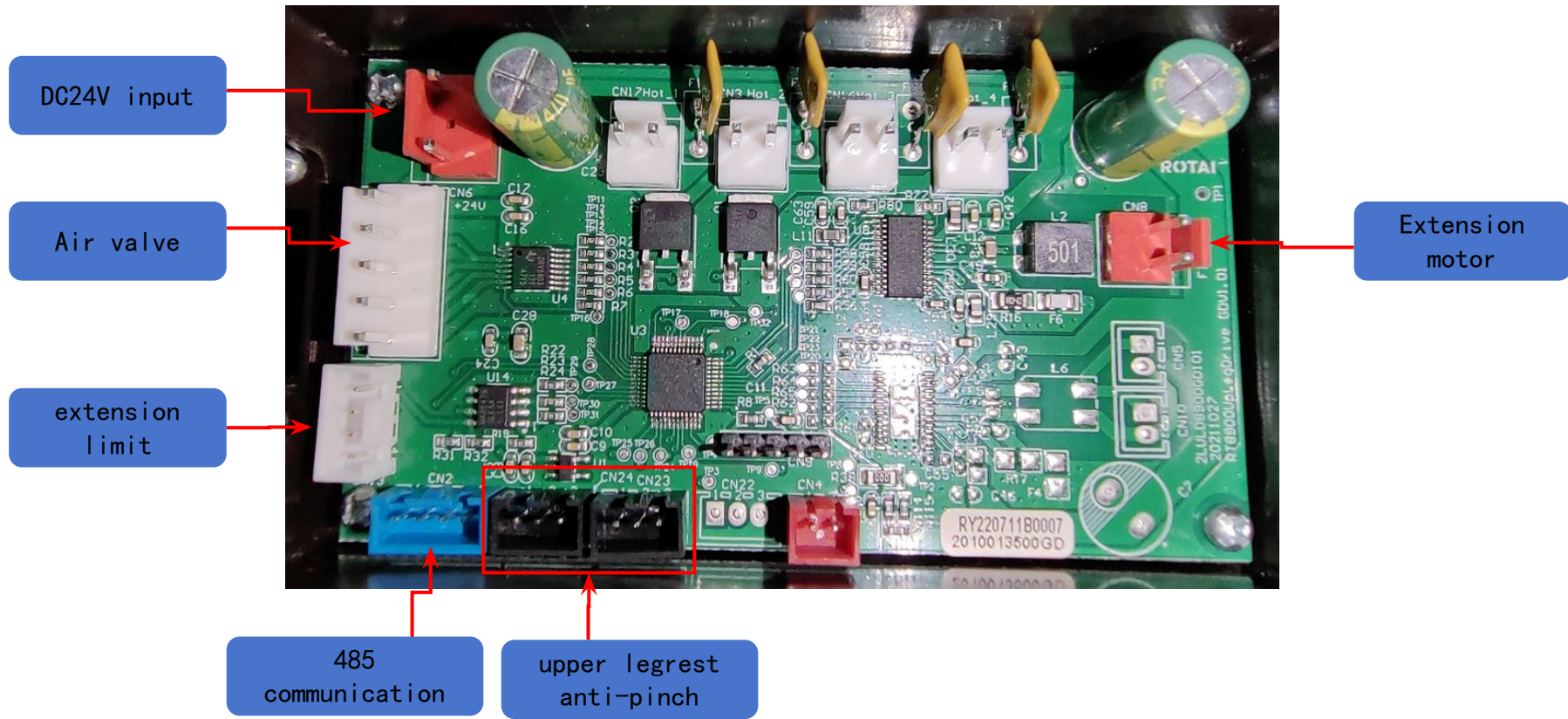

S80 lower legrest drive board

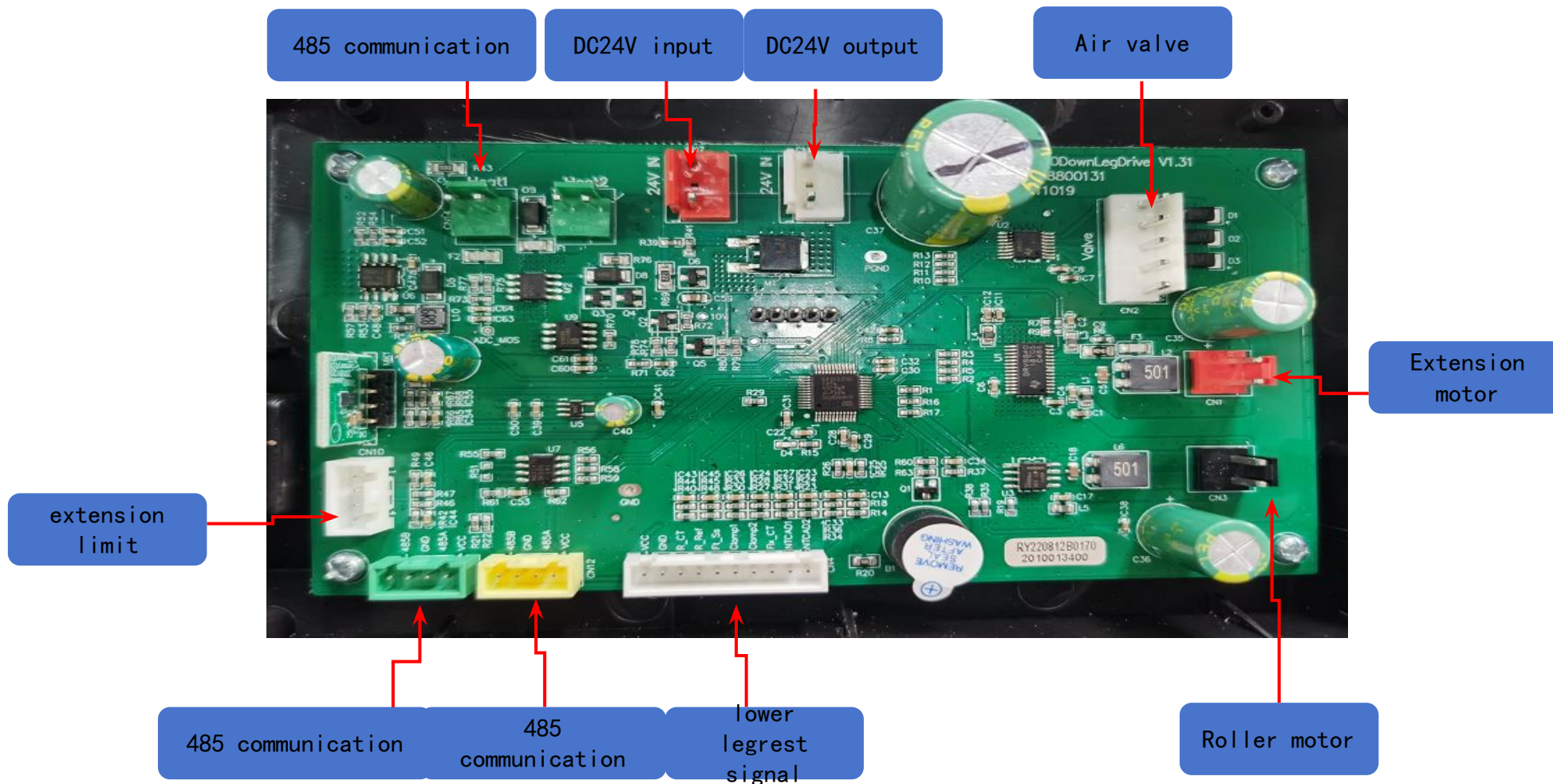

Footrest transfer board

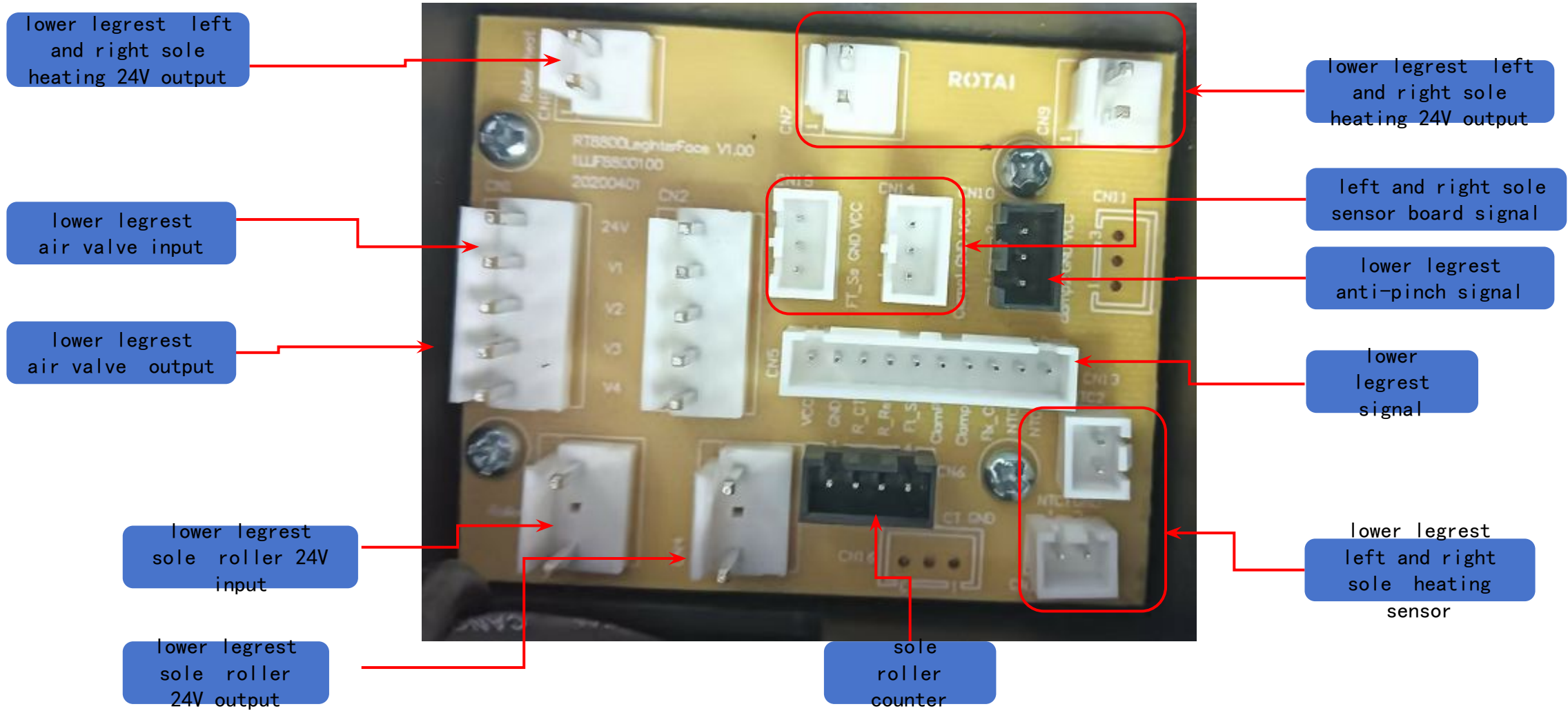

485 communication



armrest button pad

anti-pinch signal

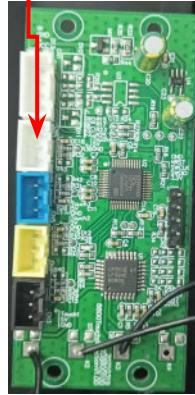

anti-pinch sensor board

485 communication

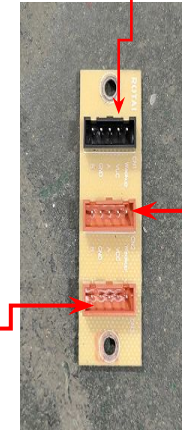

Button board and transfer board

armrest button communication connector

armrest touch communication connector

485 Huawei HarmonyOS WIFI communication

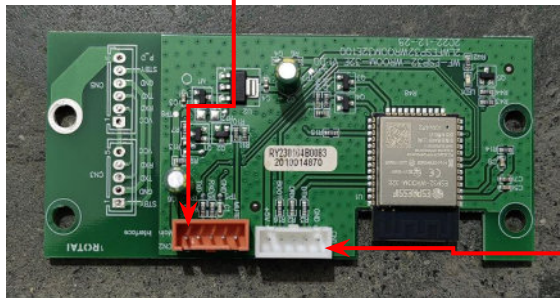

Huawei HarmonyOS WIFI board

485 communication connector

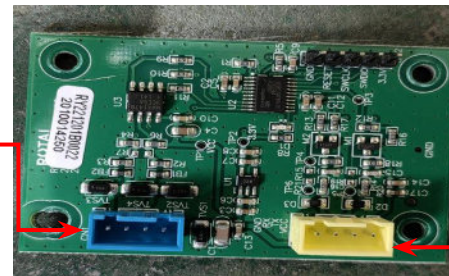

armrest health detection communication transfer board

Reserved connector

armrest health detection communication connector

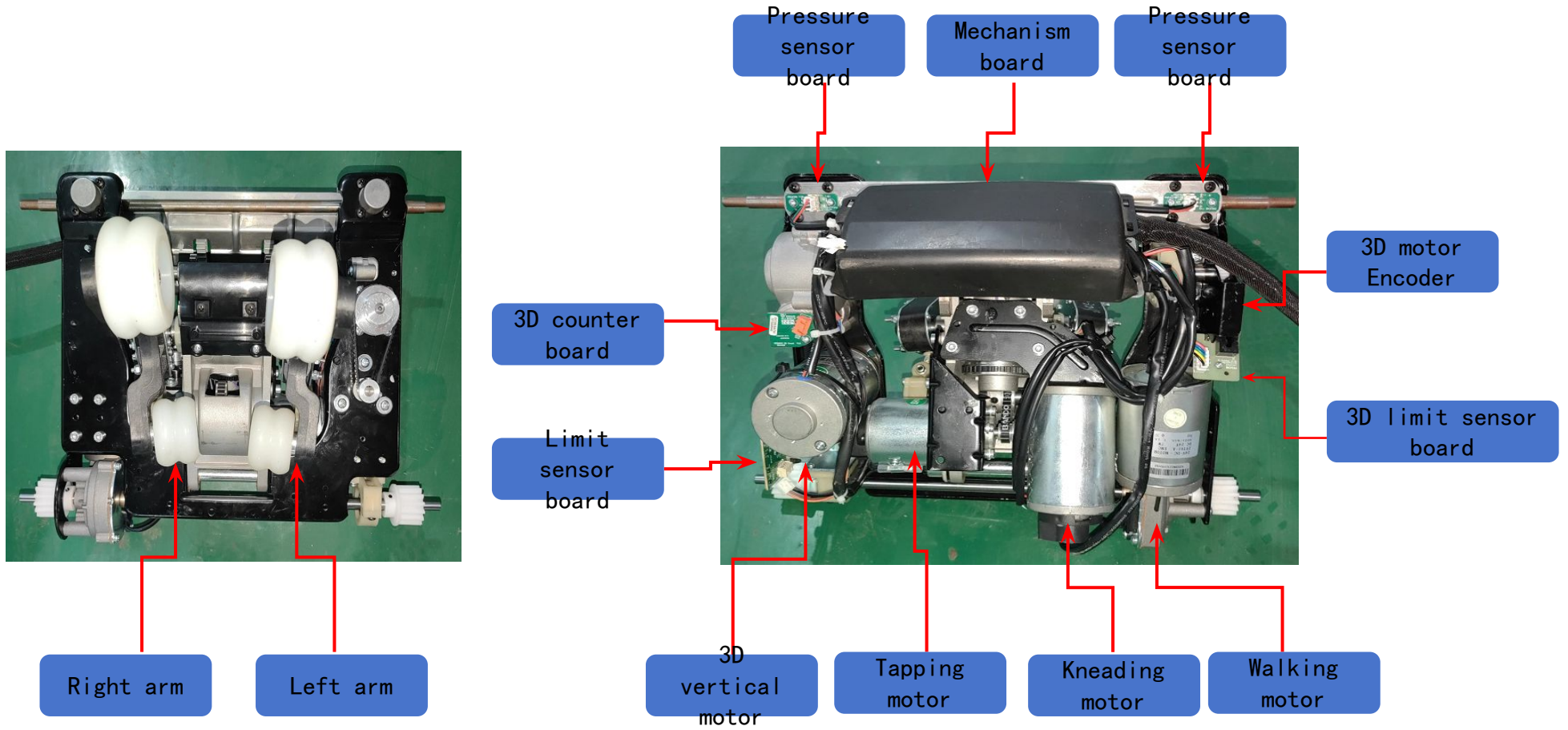

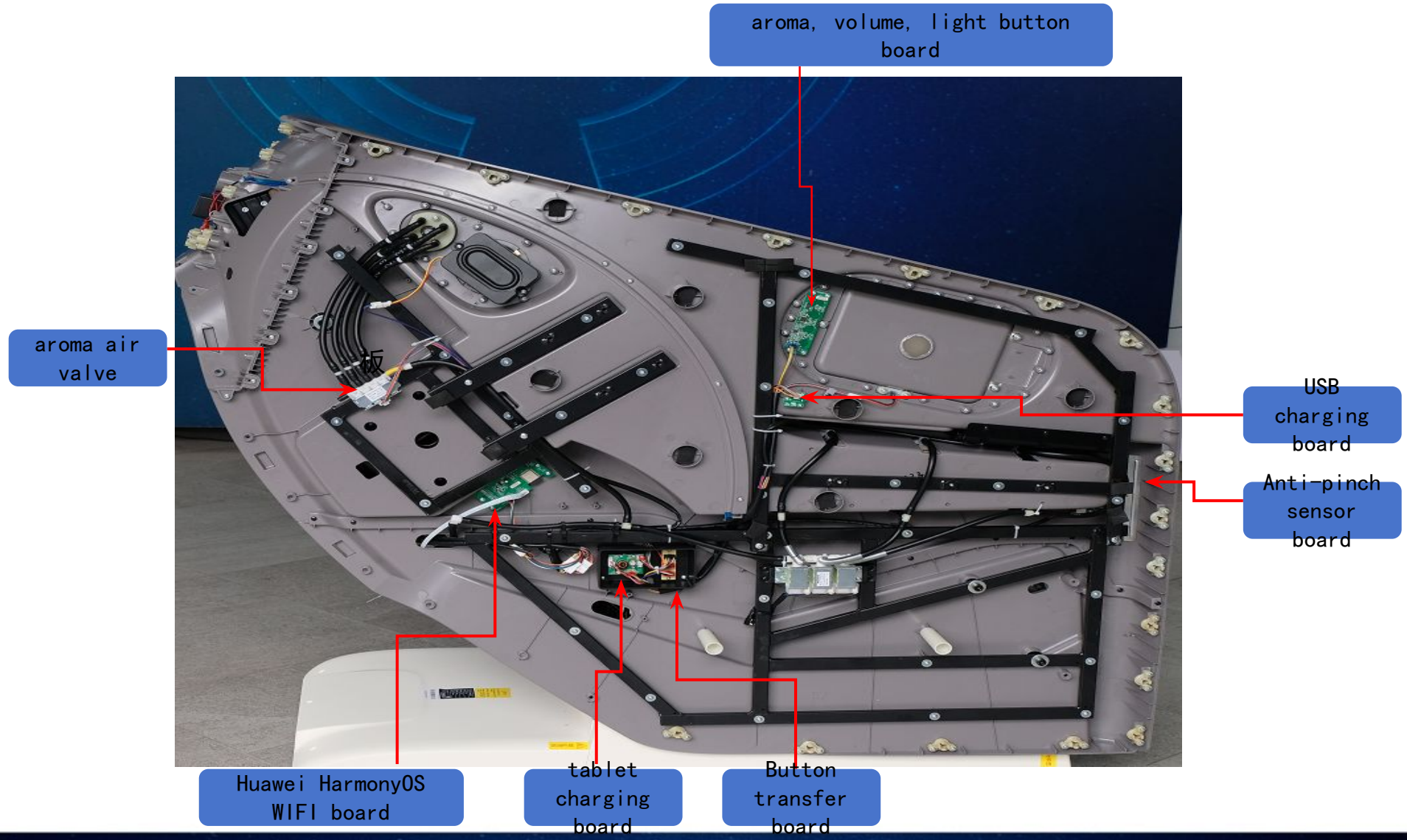

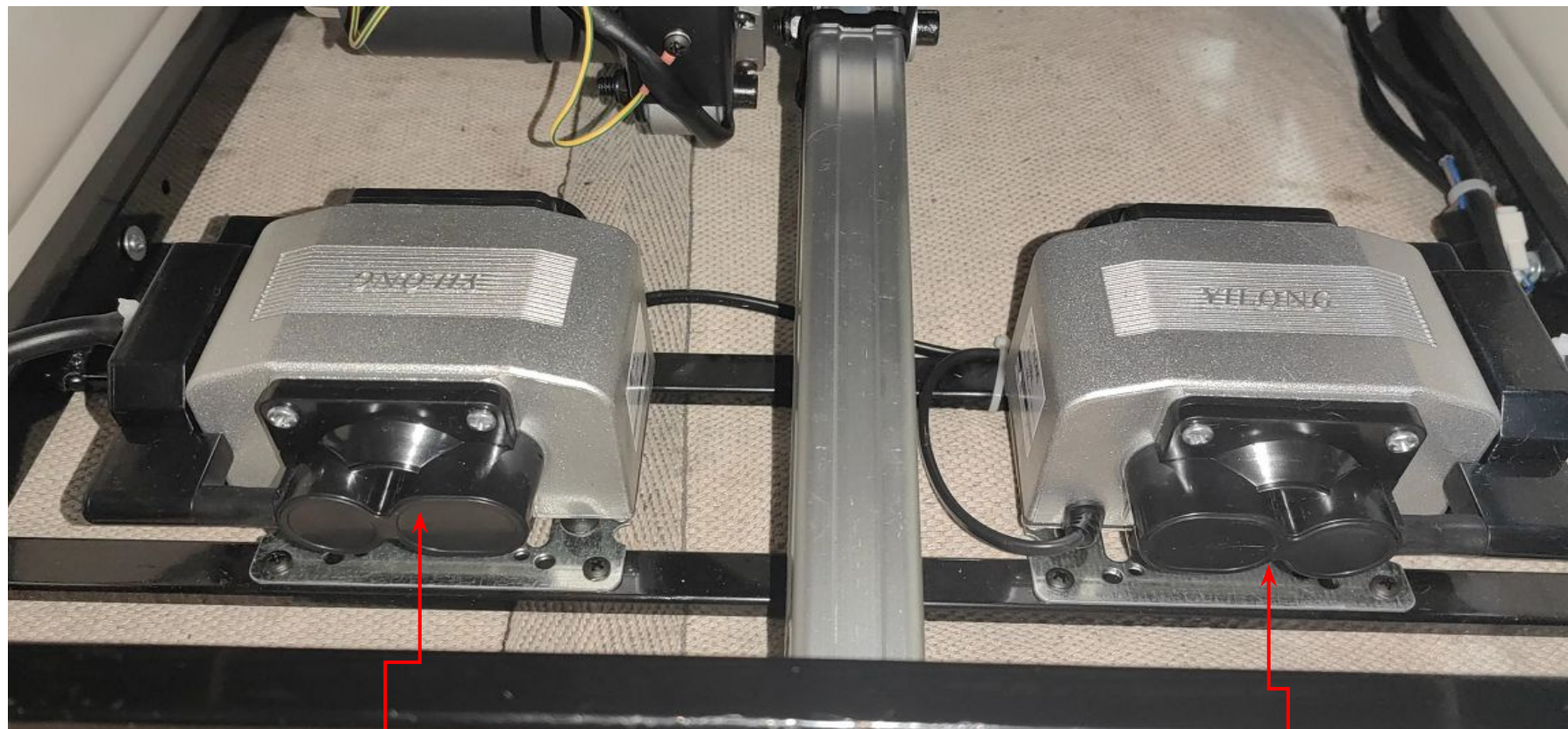

Legrest air
pump

Main chair
air pump

1. The touchscreen cannot control the massage chair

2. Burnt fuse

3. Kneading motor not working

5. Tapping motor not working

6. Walking motor not working

4. Mechanism cannot detect width

4. 3D vertical motor not working

8. Legrest actuator not working

9. Backrest actuator not working

10. Upper legrest extension not working

10. Lower legrest extension not working

11. Foot roller not working

12. Airbags not working

13. Massage chair error alert

15. Button pad not working

16. Health detection no results

17. Wireless charger not working

18. Aroma not working

19. Ambient light not working

20. Main chair heating not working

21. Leg heating not working

22. Body scan no results

1.S80 touchscreen cannot control the massage chair

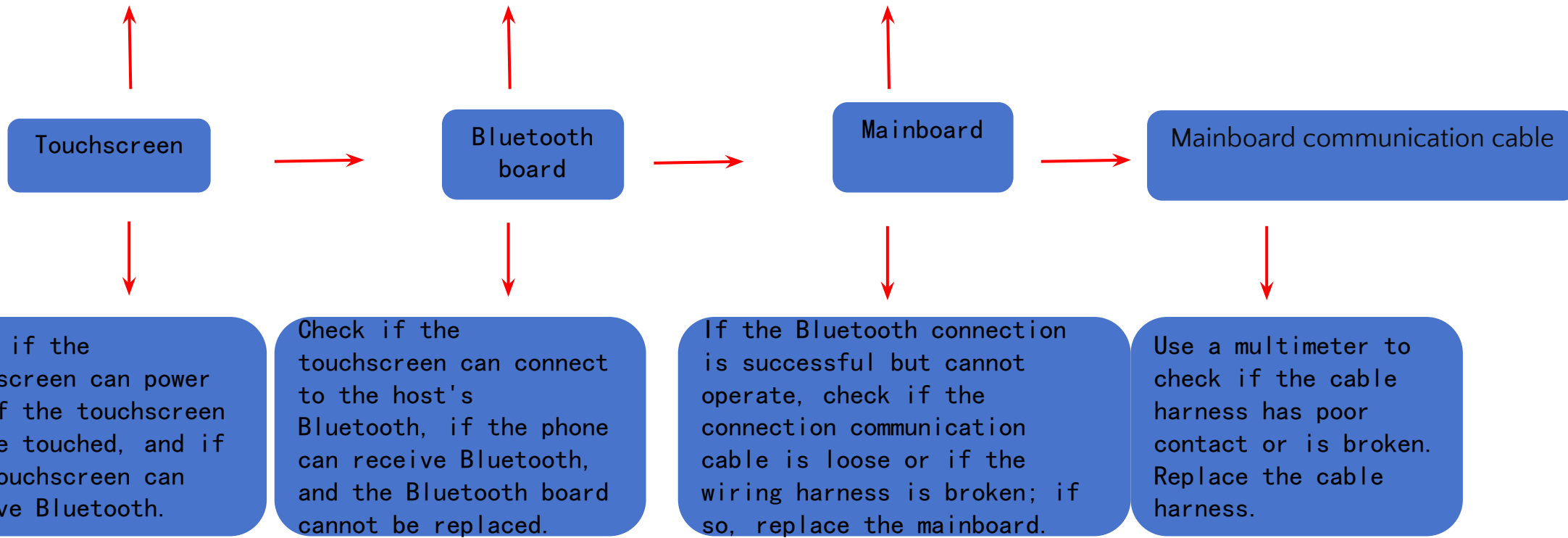
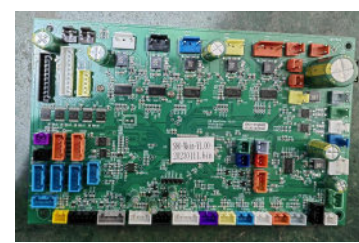

2. Burnt fuse



Burnt fuse

filter board is short circuited

Power board is short circuited

Drive board is short circuited

A certain load is short circuited

1. Replace the fuse with the same type if the voltage fluctuations cause the fuse to blow out.

2. If the fuse is blown again, unplug the red marker connector on the power supply board and power on, if fuse is blown again then replace a filter board.

If the fuse blows, power off and reset the electrical plug-in. Then, unplug the 220V primary plug from the power board, power on again, and if the fuse blows, it indicates a short circuit in the power board. Replace the power board.

Reset the 24V input plug on the mainboard, unplug all other plugs on the mainboard, and power on again. If the fuse blows, it indicates a short circuit in the mainboard. Replace the mainboard.

If not, re-plug all connectors one by one to check which connected part short circuited. Replace with a new part upon confirmation of the short circuited parts.

3. Kneading motor not working



Kneading motor malfunctions

Mainboard malfunctions

Loose/broken connection cable

1. Use controller to power on the chair, select MANUAL mode -SYNC Massage. Connect kneading motor to tapping motor connector port on the mechanism mainboard, and check if the kneading motor works. If not, replace the kneading motor.

2. If it works, the mainboard is faulty. Replace the mechanism mainboard.

3. Use a multimeter to check if the cable harness has poor contact or is broken. Replace the cable harness.

4.S80 Tapping motor not working



Knocking motor malfunctions

Mainboard malfunctions

Loose/broken connection cable

1. Use controller to power on the chair, select MANUAL mode -SYNC Massage. Connect tapping motor to kneading motor connector port on the mechanism mainboard, and check if the knocking motor works. If not, replace the knocking motor.

2. If it works, the mechanism mainboard is faulty. Replace the mechanism mainboard.

3. Use a multimeter to check if the cable harness has poor contact or is broken. Replace the cable harness.

5. S80 Walking motor not working



Distance limit sensor board is damaged

Walking motor malfunctions

Mainboard malfunctions

Loose/broken connection cable

1. Switch on the controller and power on the chair, select MANUAL mode-SYNC message, then choose POINT message, press the "UP" or "DOWN" button to check if it double beeps. If there are fast beeping sounds, distance limit detection board is damaged and replace with a new one if needed.

2. If both have slow single beeping sound, the limit sensor signal is good, then unplug mechanism walking motor connector (black color) and plug it into tapping motor connector socket (red color) to check if walking motor works. If no, the motor is damaged and needs to be replaced.

3. Plug the motor back to its original position, exchange walking motor connector and kneading motor connector to check if the walking motor functions. If motor moves then replace the mainboard, if motor fails to move, the motor cable is loose or broken, replace with a new cable.

3. Use a multimeter to check if the cable harness has poor contact or is broken. Replace the cable harness.

6.S80 Mechanism cannot detect width

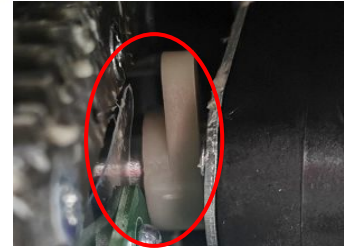
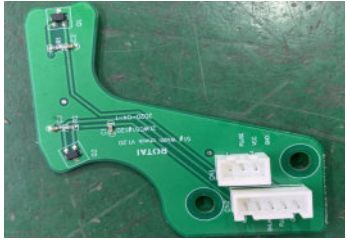

Width board

Kneading motor counter board

Magnet stand

Loose/broken connection cable

1. Enter engineering mode, activate kneading, and check for changes in width values. If none, replace the width board.

2. In engineering mode, activate kneading, check if kneading counter is normal. If not, replace the kneading motor.

3. Check if the magnet stand is normal or damaged. If damaged, replace it.

4. Use a multimeter to check if the cable harness has poor contact or is broken. Replace the cable harness.

7.S80 3D vertical motor not working

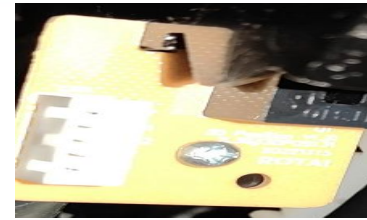

3D vertical motor malfunctions

Mechanism mainboard malfunctions

3D limit sensor board malfunctions

Loose/broken connection cable

1. Select MANUAL mode, KNEADING massage. Switch 3D motor connector with kneading motor connector on the mechanism mainboard. If motor does not work, replace with a new motor.

2. If it's good, the connection wire or connection pin is damaged (use multimeter to test); If all are good, replace the mainboard.

3. If it works, then check the 3D motor 5V voltage (red yellow wire around 5V, yellow blue wire around 4.5V, yellow green around 4.5V). If output voltage is normal, then replace limit sensor board.

4. Use a multimeter to check if the cable harness has poor contact or is broken. Replace the cable harness.

8.S80 Legrest actuator not working

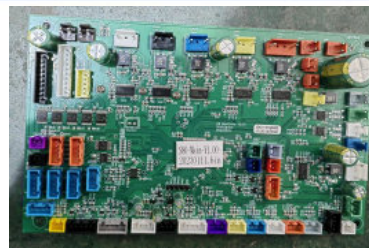
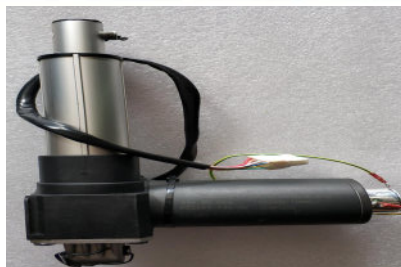

Actuator
malfunctions

Loose/broken
connection
cable

Mainboard
malfunctions

Power on, press the leg rest up/down button, and use a multimeter to check if the actuator has resistance. If there is no resistance, actuator is faulty and needs to be replaced.

Use a multimeter to check if the cable harness has poor contact or is broken. Replace the cable harness.

If the cable is good, replace the mainboard

9.S80 Backrest actuator not working

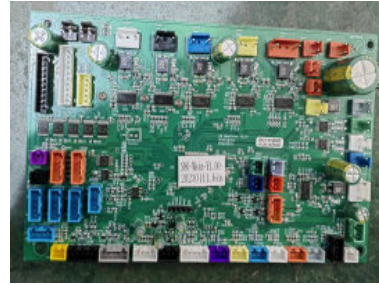

Actuator malfunctions

Loose/broken connection cable

Mainboard malfunctions

Power on, press the backrest up/down button, and use a multimeter to check if the actuator has resistance. If there is no resistance, actuator is faulty and needs to be replaced.

Use a multimeter to check if the cable harness has poor contact or is broken. Replace the cable harness.

If the cable is good, replace the mainboard

10.S80 lower legrest extension motor not working



Legrest extension
limit sensor board
malfunctions

Lower legrest
mainboard
malfunctions

Extension motor
malfunctions

Loose/broken
connection
cable

1. Adjust the lower legrest extension using the hand controller, listen to the sound. If the legrest stops in the reset position and there is a fast sound, it indicates an issue with limit sensor, and needs to replace the limit sensor board or checking if the limit detection board connection wire is open. If there is a slow sound, it suggests a motor or legrest mainboard issue with no motor working voltage output.

2. Switch on the leg extension function, use the multimeter to test legrest mainboard for DC24V voltage output, if there is no voltage output, replace the mainboard.

3. If there is, then replace the extension motor.

4. Use a multimeter to check if the cable harness has poor contact or is broken. Replace the cable harness.

11.S80 upper legrest extension motor not working

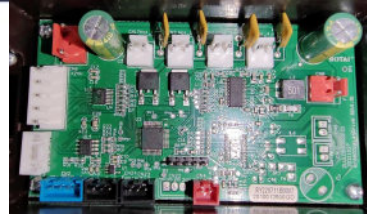

Upper legrest extension limit sensor board malfunctions

Upper legrest mainboard malfunctions

Extension motor malfunctions

Loose/broken connection cable

1. Adjust the upper legrest extension using the hand controller, listen to the sound. If the legrest stops in the reset position and there is a fast sound, it indicates an issue with limit sensor, and needs to replace the limit sensor board or checking if the limit detection board connection wire is open. If there is a slow sound, it suggests a motor or legrest mainboard issue with no motor working voltage output.

2. Switch on the leg extension function, use the multimeter to test legrest mainboard for DC24V voltage output, if there is no voltage output, replace the mainboard.

3. If there is, then replace the extension motor.

4. Use a multimeter to check if the cable harness has poor contact or is broken. Replace the cable harness.

12.S80 Foot roller motor does not work



Legrest mainboard malfunctions

Roller motor malfunctions

Loose/broken connection cable

1. Switch on the foot roller function, use the multimeter to test the connector plug of legrest mainboard for DC24V voltage output, if no, replace the legrest mainboard.

2. If yes, replace the roller motor.

3. Use a multimeter to check if the cable harness has poor contact or is broken. Replace the cable harness.

13. S80 Airbags not working

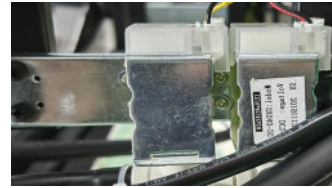
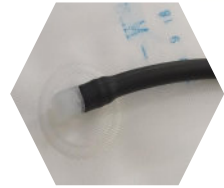

Air hose

Air valve

Mainboard

Air pump

1. If part of the airbags fail to inflate, check the air hoses in that area to see if they are folded or fell off.

2. If air hose and airbags are good, use a multimeter to test air valve connector, if the black probe and yellow probe read between 160-170, air valve is good, otherwise the air valve is damaged.

3. If the air pump vibrates, check if the mainboard air valve has AC24V output. Replace the mainboard if not.

4. If all airbags fail to work, check if the air pump is functioning. If the air pump is not working, check if the mainboard has an output of AC24V. If there is an output, replace the air pump; if not, replace the mainboard.

14. S80 Error Alert

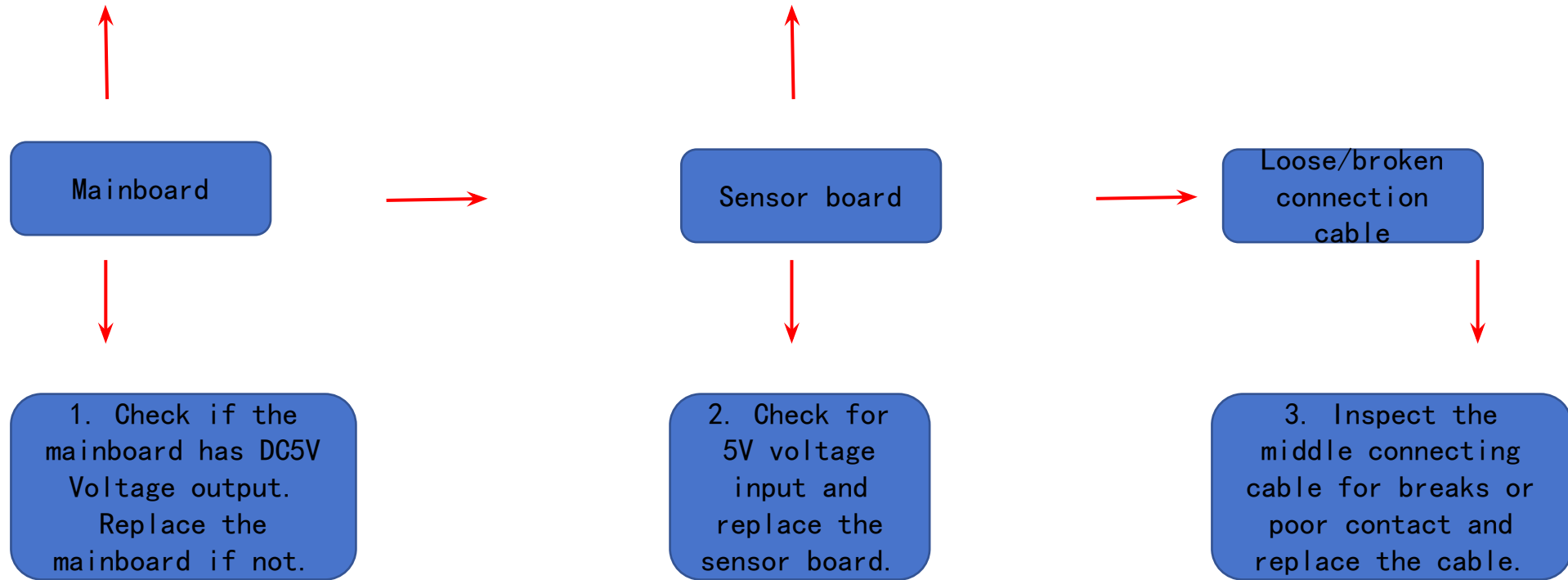

15.S80 Button pad not working

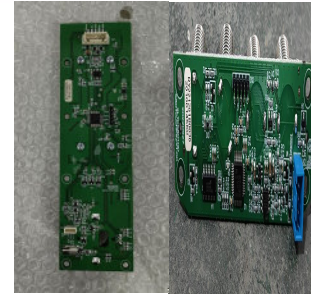
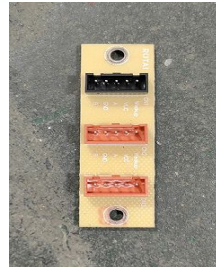

Mainboard

485 Communication transfer board

button pad

Loose/broken connection cable

Check if there is 5V voltage or signal output on the mainboard. If there is no voltage or signal output, replace the mainboard.

Check if the 5V power supply on the 485 communication board is normal.

If the 5V power supply is normal on the mainboard and the transfer board, replace the button pad.

Check if the button pad connector is loose, if any pins are disconnected, or if the cable is broken. If any issues are found, replace the cable.

16.S80 Health detection no results

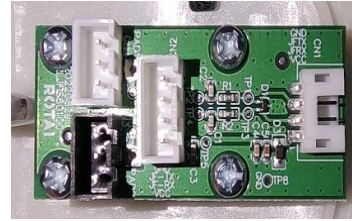

Mainboard

transfer board

Armrest Health Detection Module

Loose/broken connection cable

1. Check if there is a DC5V voltage output on the mainboard. If there is no voltage output, replace the mainboard.

2. Check if the 5V voltage on the transfer board is normal.

3. Check if there is a DC5V voltage output on the health detection board. If there is no voltage output, replace the health detection board.

4. Inspect the middle connecting cable for breaks or poor contact and replace the cable.

17.S80 Wireless charger not working

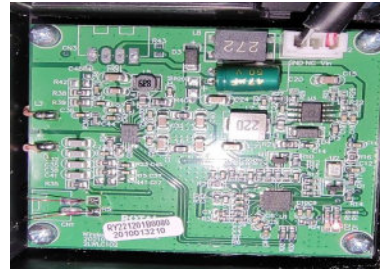

Mainboard

charging board

Loose/broken connection cable

Check if there is a DC24V voltage output on the mainboard. If there is no voltage output, replace the mainboard.

Check if there is a DC24V input on the charging board. If there is voltage input, replace the charging board.

Inspect the middle connecting cable for breaks or poor contact and replace the cable.

18.S80 Aroma not working

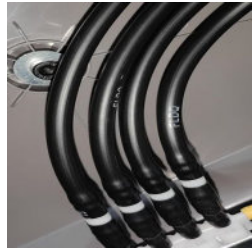

Air hose

Air valve

Mainboard

Loose/broken connection cable

1. check the air hoses in the aroma area to see if they are folded or fell off.

If the air hose is normal, use the multimeter to check air valve. If the red & white probe and the green probe read is not within the range of 155-165, the air valve is faulty and should be replaced.

Check if there is a DC24V voltage output on the mainboard. If there is no voltage output, replace the mainboard.

Inspect the middle connecting cable for breaks or poor contact and replace the cable.

19.S80 Ambient light not working

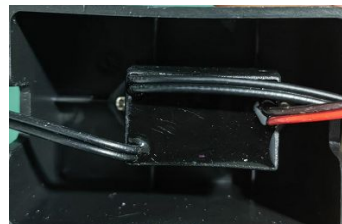

Mainboard

High Voltage Package

Ambient light

Loose/broken connection cable

Check if there is a DC24V voltage output on the mainboard. If there is no voltage output, replace the mainboard.

Check if there is an AC voltage of around 160V on the high voltage package. If there is no voltage output, replace the high voltage package.

If there is a voltage output, replace the ambient light.

4. Inspect the middle connecting cable for breaks or poor contact and replace the cable.

20. S80 Main chair heating not working

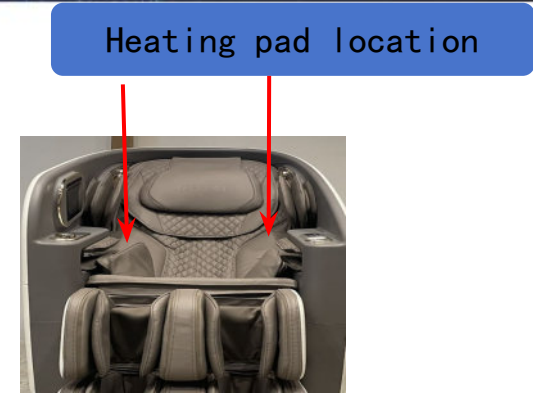

Mainboard

Loose/broken connection cable

Heating pad

Use a multimeter to measure if there is a DC24V output at the heating connector on the mainboard. If there is no output, replace the mainboard

Measure the cable. If the cable is faulty, replace the cable.

If the cable is good, replace the heating pad.

21.S80 Leg heating not working

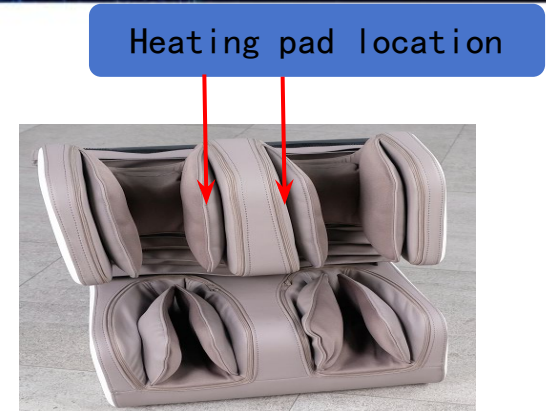

Mainboard

Loose/broken
connection cable

Heating pad

Use a multimeter to measure if there is a DC24V output at the heating connector on the legrest board. If there is no output, replace the board

Measure the cable.
If the cable is faulty,
replace the cable.

If the cable is good,
replace the heating
pad.

22.S80 Body scan no results

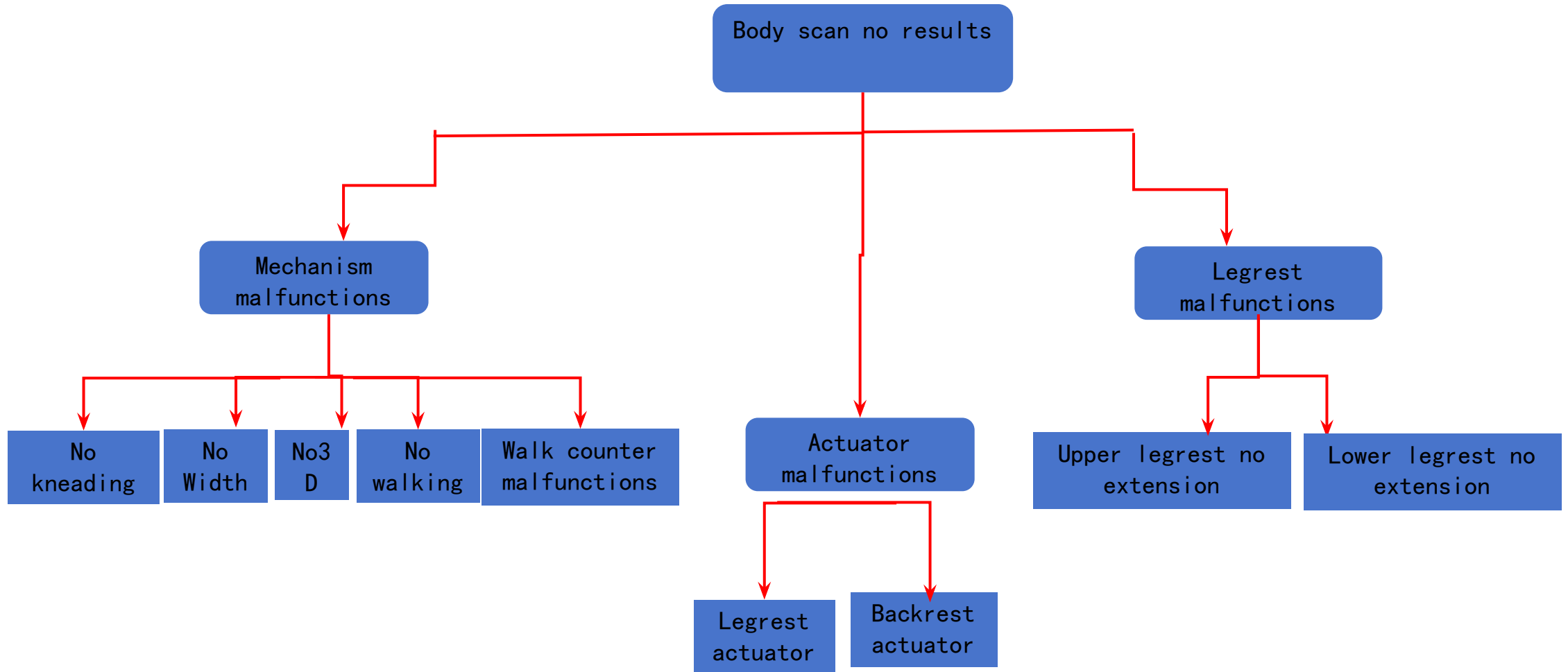

ROTAI
荣泰



ROTAI
More Professional Massage Chairs