

Osaki



OS4000 Maintenance Service Manual

MODEL: OS4000

Voltage specification: 110-120V

By Customer Service Department

Model	OS4000
--------------	---------------

Table of Contents

I.....Specifications	3
II.....Appearance of the chair	4
III.... Name and functions of components (remote controller)	5
IV.....Malfunction catalog.....	6~8
V.....Troubleshooting flow chart.....	9~13
VI.....Maintenance of the back rest	14~19
VII....Maintenance of the seat part	20~25
VIII....Maintenance of the footrest	26~29

I. Specifications

Description	Specifications
Model No.	OS-4000
Rated Voltage	120V AC
Rated Frequency	60HZ
Rated Power Consumption	250W
Timer	5/10/15/25/30 minutes
Max Time Rate	60 minutes
Dimensions(LxWxH)	Product carton: 52.4" X 30.3" X 37.2"
	Side panel carton: 37.8" X 25.6" X 15"
Weight	Product gross weight: 284.4 lbs
	Product net weight: 244.8 lbs
Length of Wire	Controller wire: 1.3m
	Power supply wire: 2.2m
Usage Condition	Environment temperature: 10°-40°
	Contrasting humidity level: 30-85RH
Storage Condition	Storage temperature: 20°-60°
	Storage humidity level: 30-85RH
Safety feature	Equipped with overheated and power surge safety protection
Using benefits	Increasing blood circulation Relieving muscular fatigue

II. Appearance of the chair

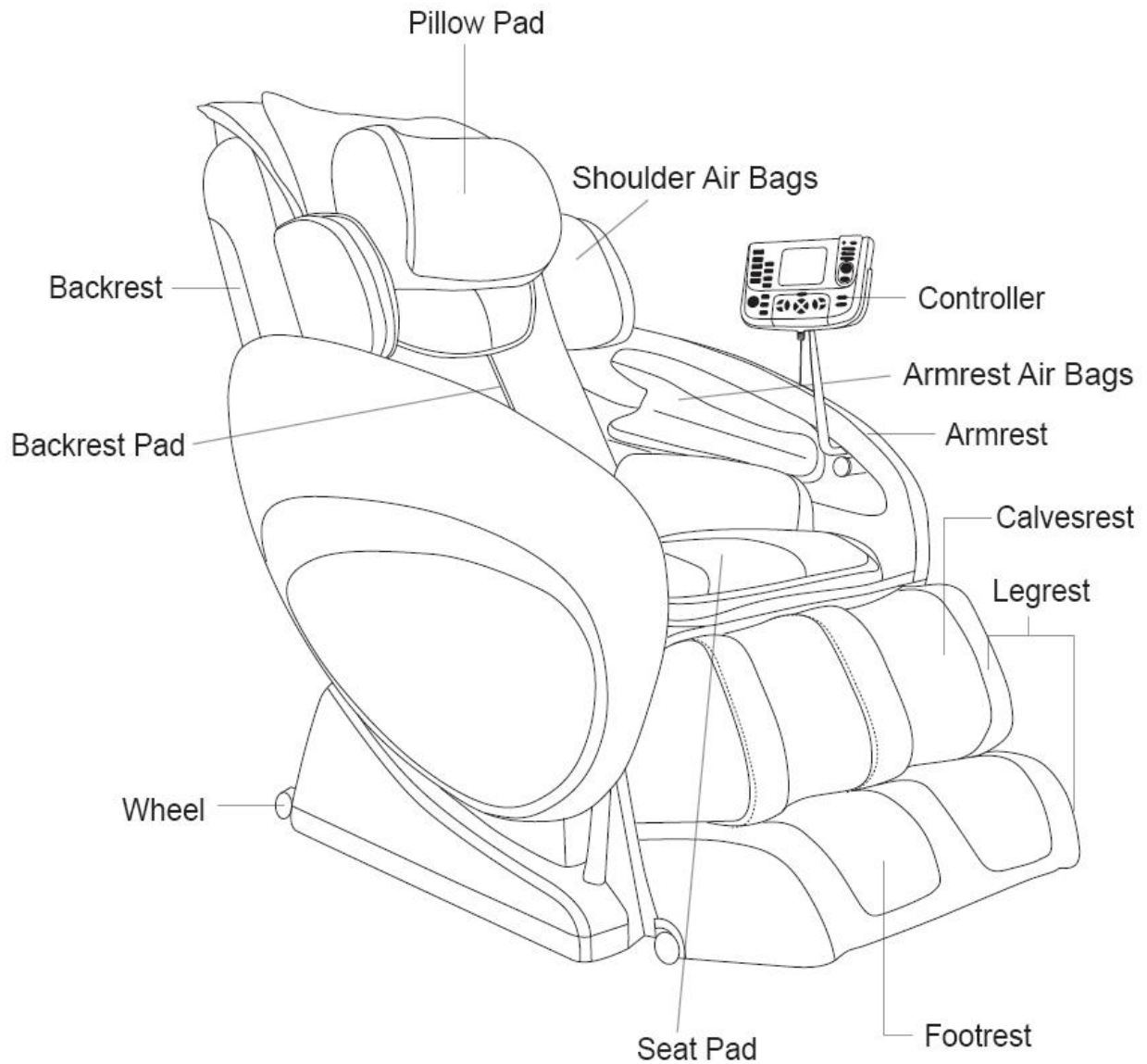

III.Name and functions of components (remote controller)

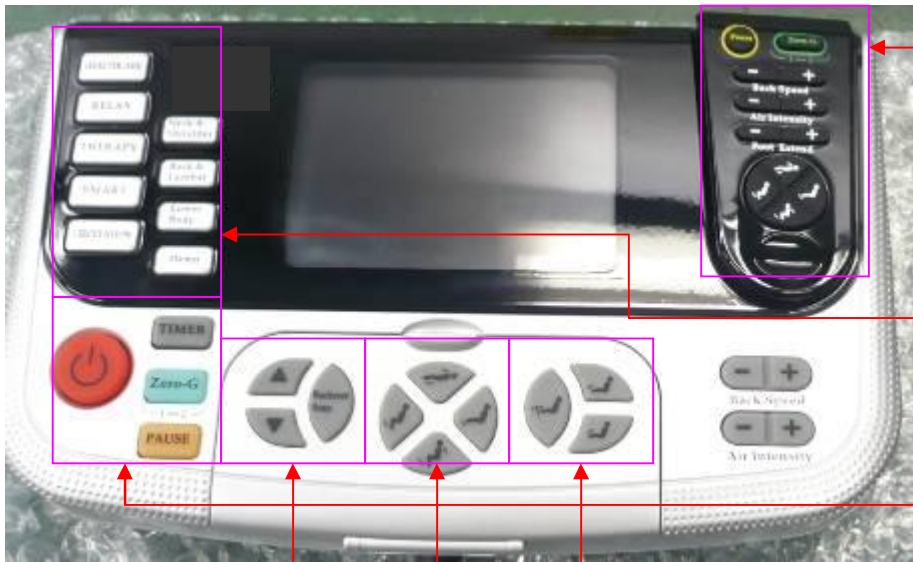

Remote controller

Auto-program buttons

Main control buttons

The adjustment button for back body

Angle adjustment button

Length auto adjustment buttons for legrest



LCD

Sensor receiver

Back speed/Air intensity

Manual back massage programs

IV. Malfunction catalog

Common Troubles and Maintenance Methods are listed as following:

Serial NO.	Phenomenon	Description	Maintenance Methods	Refer to
01	No Function When Starting.	The LCD isn't illuminating: ① Fuse(s) burn out (the one Is in the Power Source Box and the other one on the main PCB). ②Power supply circuit poorly connected. ③EMC Board fails. ④main PCB fails.	① Replace Fuse(s). ② Replace the power supply cord. ③ Replace EMC Board. ④ Replace main PCB.	① Page 25/20 ② (Ellipsis) ③&④ Page 23-24/18
02	No function when starting.	The LCD is illuminating: ① The Up or Down Stroke Photo-electricity fails. Main PCB fails. ②Kneading is on without pressing any key when starting and no response by pressing other keys.	① Replace the Up or Down Stroke Photo-electricity. ②Replace the main PCB. ③Width Inspection Board of PCB fails, replace it.	① Page 19/8 ②Page 23-24/18 ③ Page 18/7.1
03	No Width switchover.	① The terminals of Width Inspection on main PCB and wires are poorly connected. ② The terminals of Width Inspection on massage mechanical and wires are poorly connected. ③ Width Inspection fails. ④ Main PCB fails.	①&②Plug the terminal securely or replace the wires. ③ Replace Width Inspection. ④ Replace the main PCB.	①&②&③ Page 18/7.1 ④Page 23-24/18

04	No Rolling.	<p>①Terminal or Wire Poorly Contacts.</p> <p>②Down-stroke Photo-Electricity Subassembly Fails.</p> <p>③Up-stroke Photo-electricity Subassembly Fails.</p> <p>④Rolling Motor Fails.</p> <p>⑤Main PCB Fails.</p>	<p>①Plug the terminal securely or replace the wires.</p> <p>②Replace Down-Stroke Subassembly.</p> <p>③Replace Up-Stroke Sub-assembly.</p> <p>④Replace Rolling Motor.</p> <p>⑤Replace main PCB.</p>	<p>①Page 23-24/18</p> <p>②&③ Page 19/8</p> <p>④Page 17/6.2</p> <p>⑤Page 23-24/18</p>
05	No kneading.	<p>①The terminals on main PCB and wires are poorly connected.</p> <p>②Kneading motor fails.</p> <p>③Main PCB fails.</p>	<p>①Plug the terminal securely or replace the wires.</p> <p>②Replace the kneading motor.</p> <p>③Replace main PCB.</p>	<p>①&③ Page 23-24/18</p> <p>②Page 16-17/6.1</p>
06	No tapping.	<p>① The terminals on main PCB and wires are poorly connected.</p> <p>② Tapping motor fails.</p> <p>③ Main PCB fails.</p>	<p>①Plug the terminal securely.</p> <p>②Replace the tapping motor.</p> <p>③Replace main PCB.</p>	<p>①&③ Page 23-24/18</p> <p>②Page 18/6.3</p>
07	No response when pressing the keys on the remote controller.	<p>①The terminals and wires are poorly connected.</p> <p>②The PCB in the remote controller fails.</p>	<p>①Plug the terminal securely or replace the wires.</p> <p>②Replace the remote controller.</p>	<p>①Page 20/11</p> <p>②Page 20/10</p>
08	Back rest cannot be reclined or raised	<p>① The terminals of reclining actuator and wires are poorly connected.</p> <p>②The reclining actuator fails.</p> <p>③Main PCB fails.</p>	<p>①Plug the terminal securely.</p> <p>②Replace reclining actuator.</p> <p>③Replace main PCB.</p>	<p>①&②Page 22/15</p> <p>② Page 23-24 /18</p>

09	Foot rest cannot be raised or lowered.	<ul style="list-style-type: none"> ① The terminals of foot rest actuator and wires are poorly connected. ②The foot rest actuator fails. ③Main PCB fails. 	<ul style="list-style-type: none"> ①Plug the terminal securely. ②Replace foot rest actuator. ③Replace main PCB. 	<ul style="list-style-type: none"> ①&②Page 22-23/16 ② Page 23-24 /18
10	No gas charging in the seat-pad.	<ul style="list-style-type: none"> ①The terminal of the snuffle valves and wires are poorly connected. ②The snuffle valves fail. ③The inflator pump fails. ④Main PCB fails. 	<ul style="list-style-type: none"> ①Plug the terminal securely. ②Replace the snuffle valves. ③Replace the inflator pump. ④Replace main PCB. 	<ul style="list-style-type: none"> ①&②&③ Page24/19 ④Page 23-24/18
11	No gas charging in the foot rest.	<ul style="list-style-type: none"> ①The terminal of the snuffle valves and wires are poorly connected. ②The snuffle valves fail. ③The inflator pump fails. ④Main PCB fails. 	<ul style="list-style-type: none"> ①Plug the terminal securely. ②Replace the snuffle valves. ③Replace the inflator pump. ④Replace main PCB. 	<ul style="list-style-type: none"> ①&②&③ Page24/19 ④Page 23-24/18
12	No gas charging in the veil for backrest	<ul style="list-style-type: none"> ①The terminal of the snuffle valves and wires are poorly connected ②The snuffle valves fail ③The inflator pump fails ④Main PCB fails 	<ul style="list-style-type: none"> ①Plug the terminal well ②Replace the snuffle valves ③Replace the inflator pump ④Replace main PCB 	<ul style="list-style-type: none"> ①&②&③ Page24/19 ④Page 23-24/18
13	No extending Or shrinking of the calves-rest	<ul style="list-style-type: none"> ①The terminals and wires are poorly connected ②The output voltage is not 24VAC ③The limit sensor fail ④Motor fails 	<ul style="list-style-type: none"> ①Plug the terminal well ②Replace the main PCB ③Replace the limit sensor ④Replace the motor 	<ul style="list-style-type: none"> ①Page 25/22 ②Page 23-24/18 ③Page 27/24 ④Page 26~27 /23

V. Troubleshooting flow chart

Notes for repairing chair or replacing parts:

- ① Make sure the power is OFF before tearing down the wires, moving terminals or replacing parts.
- ② Semiconductors (such as IC and others) are very easy to be damaged by static, so when you touch the PCB, please make sure your body is grounding (by wearing a girding static ring), or your hands are touching with earthing grip (household electrical appliances putting to earth, such as fridges, washers and so on) to release all static of the body.

1. No function when starting.

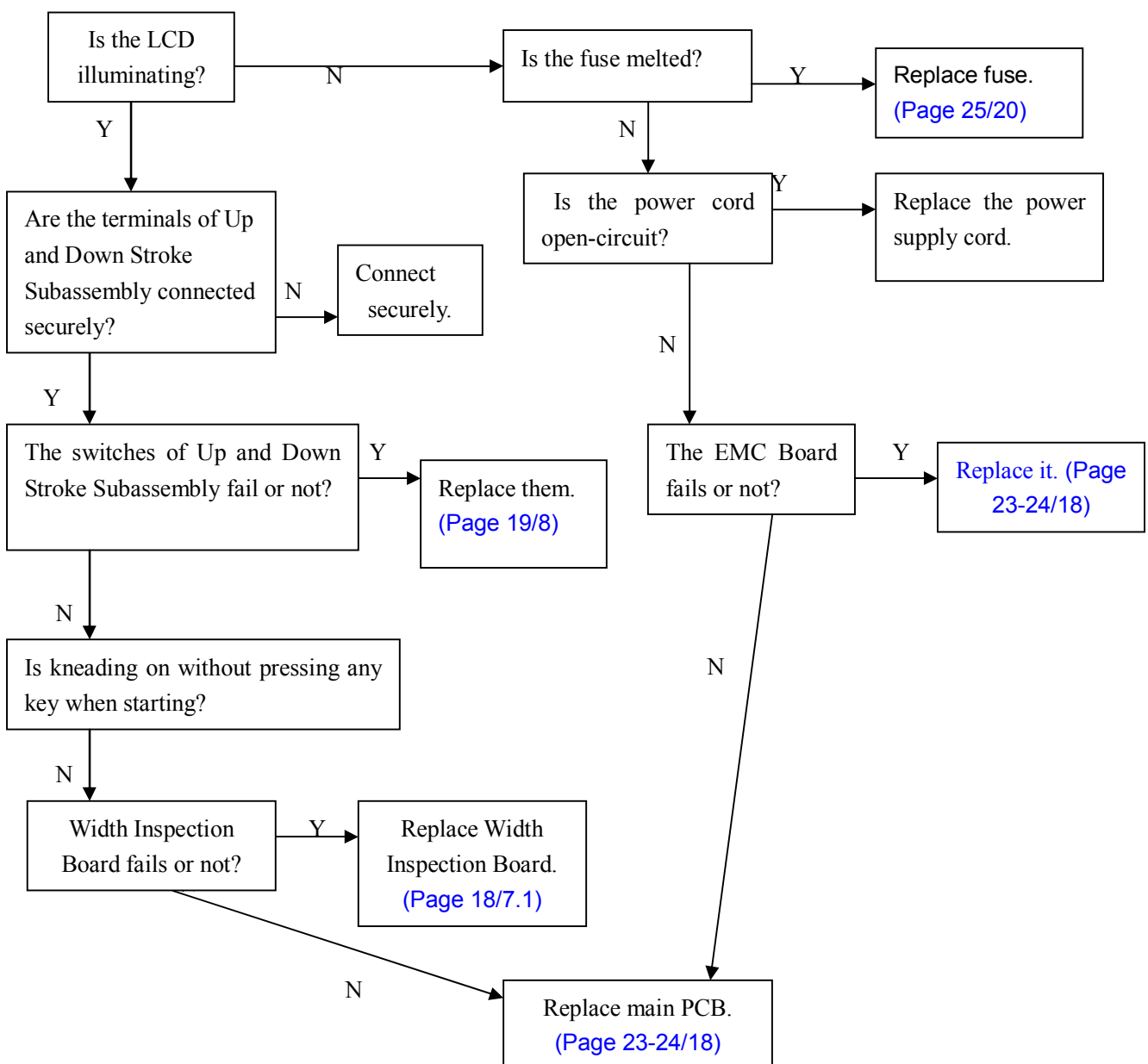

2. No width switchover.

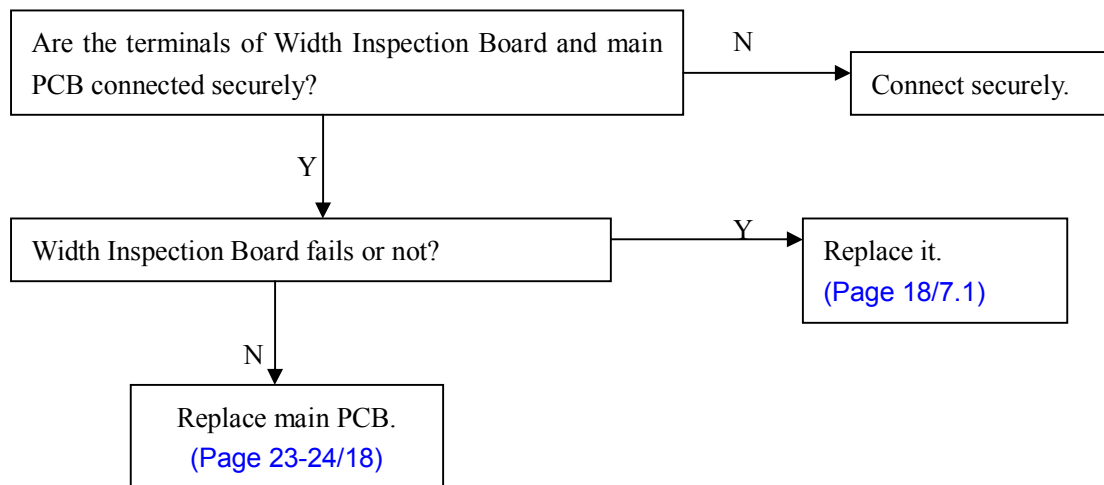

3. No function (fixed-spot or partial)

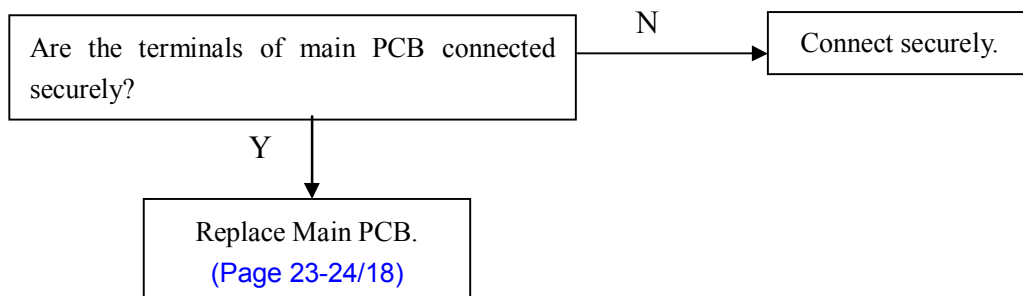

4. No rolling

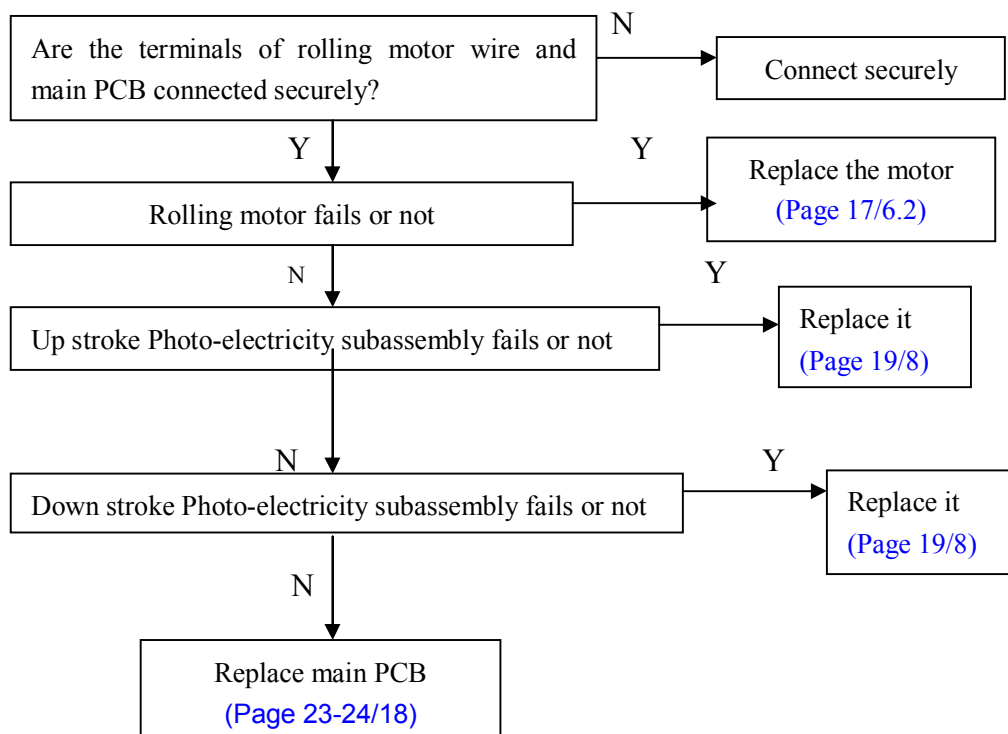

5. No kneading

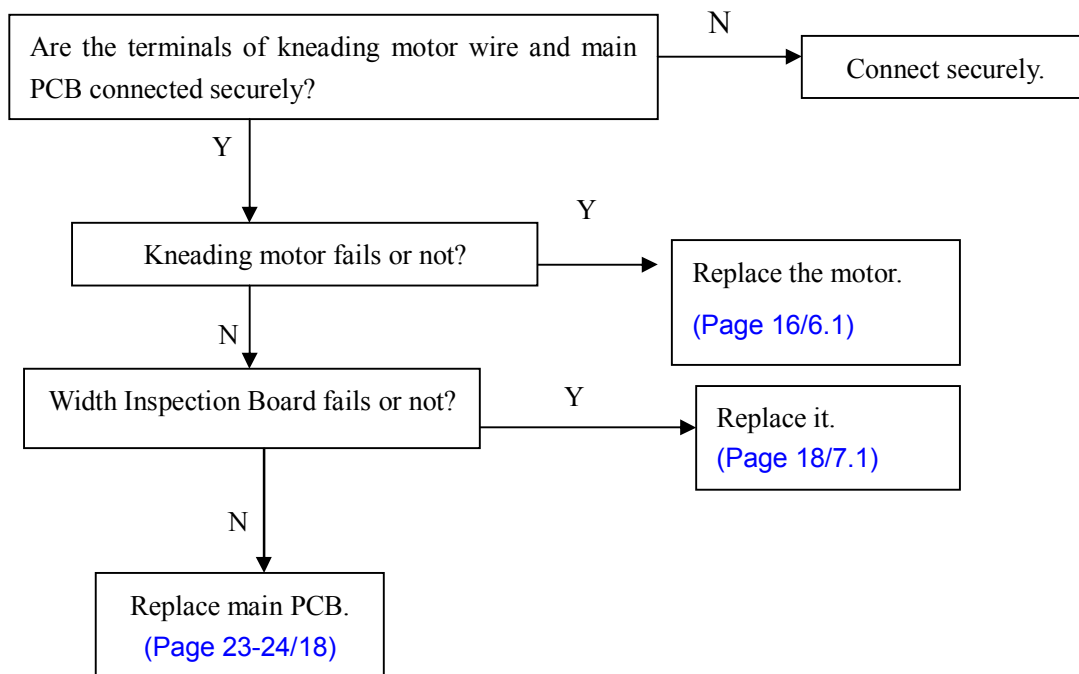

6. No tapping.

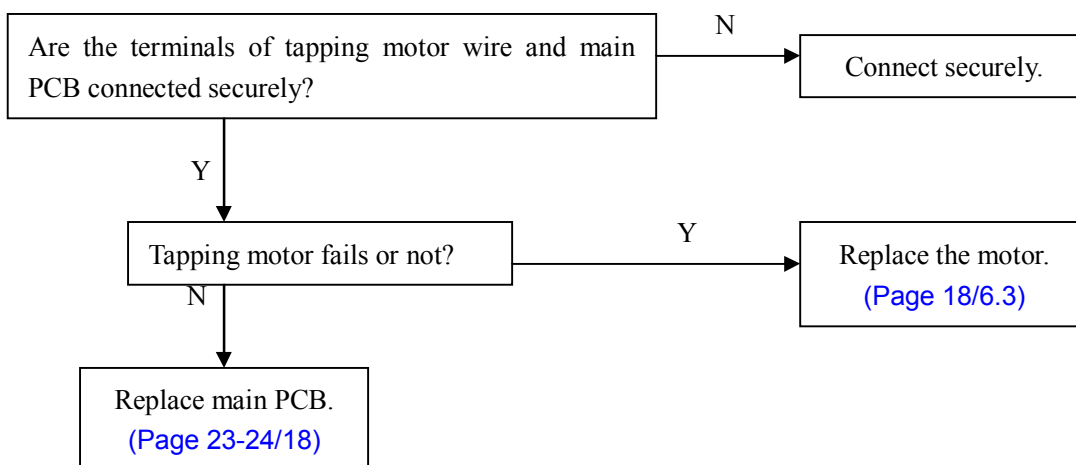

7. Remote controller doesn't work.

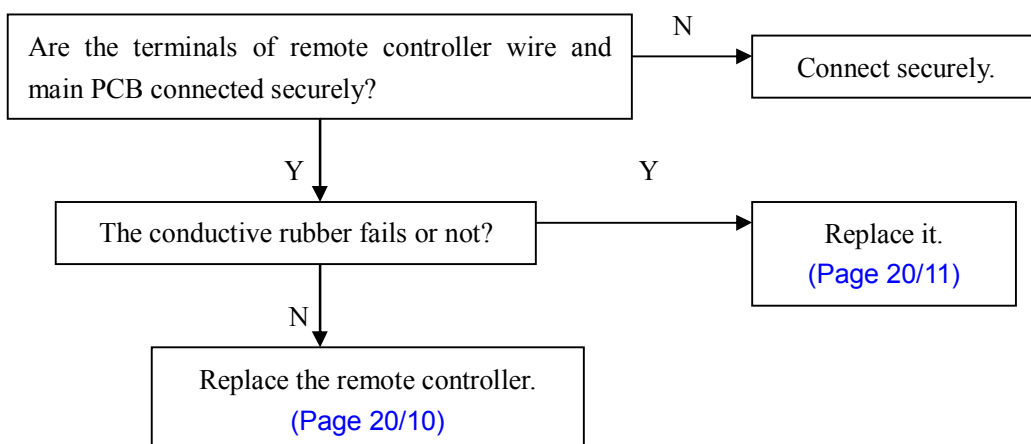

8. Actuator doesn't work.

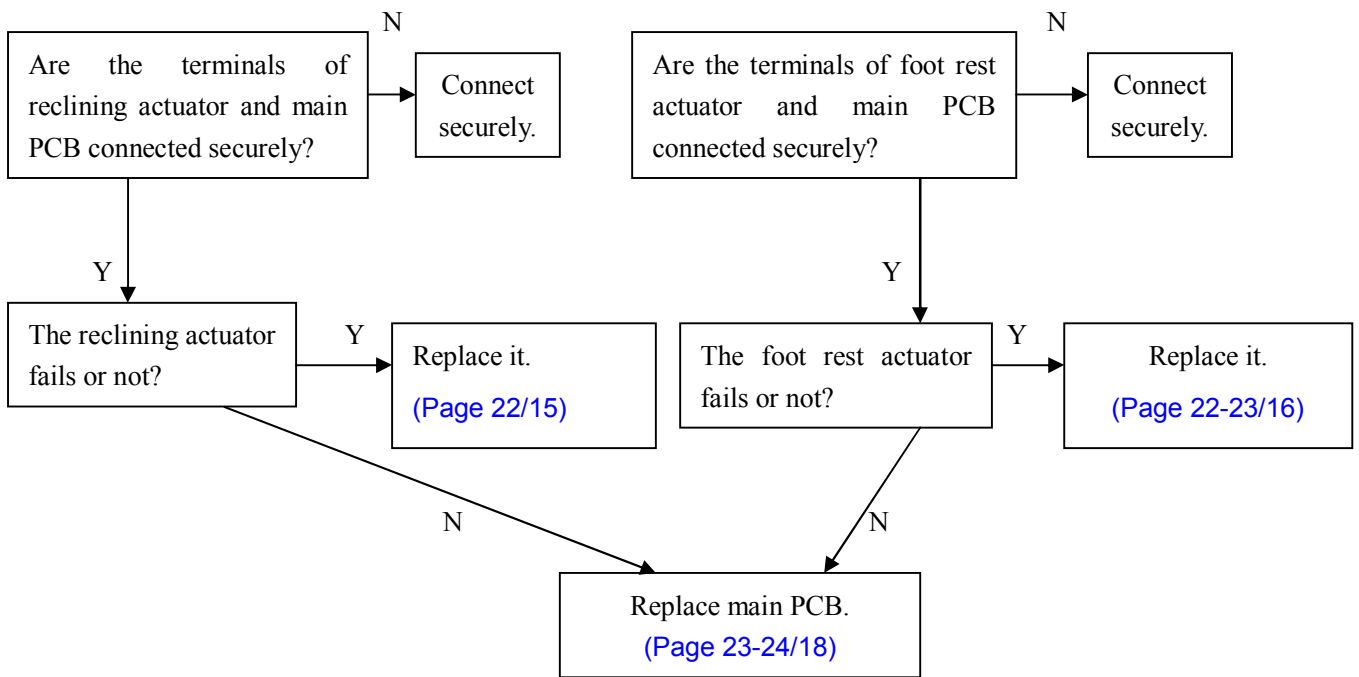

9. No gas charging.

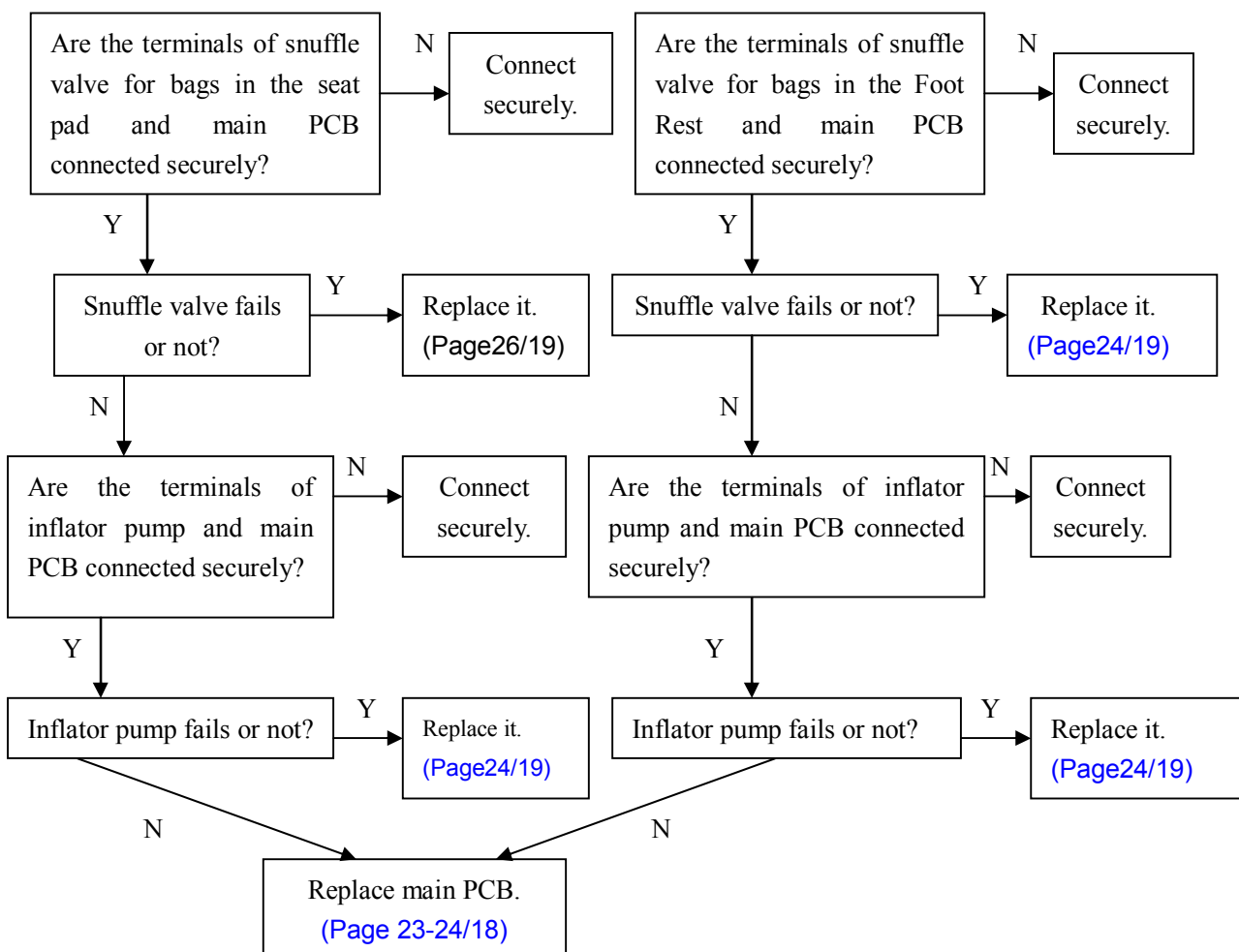

10. No gas charging in the outer coating of backrest

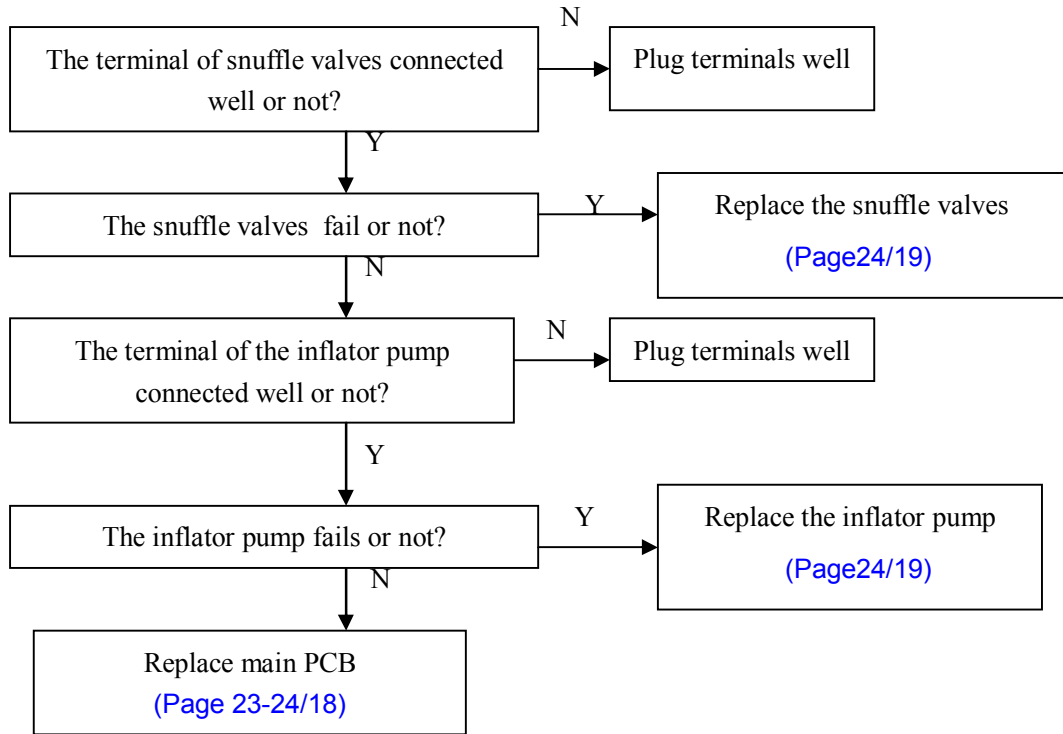

12. No extending or shrinking of the calves-rest

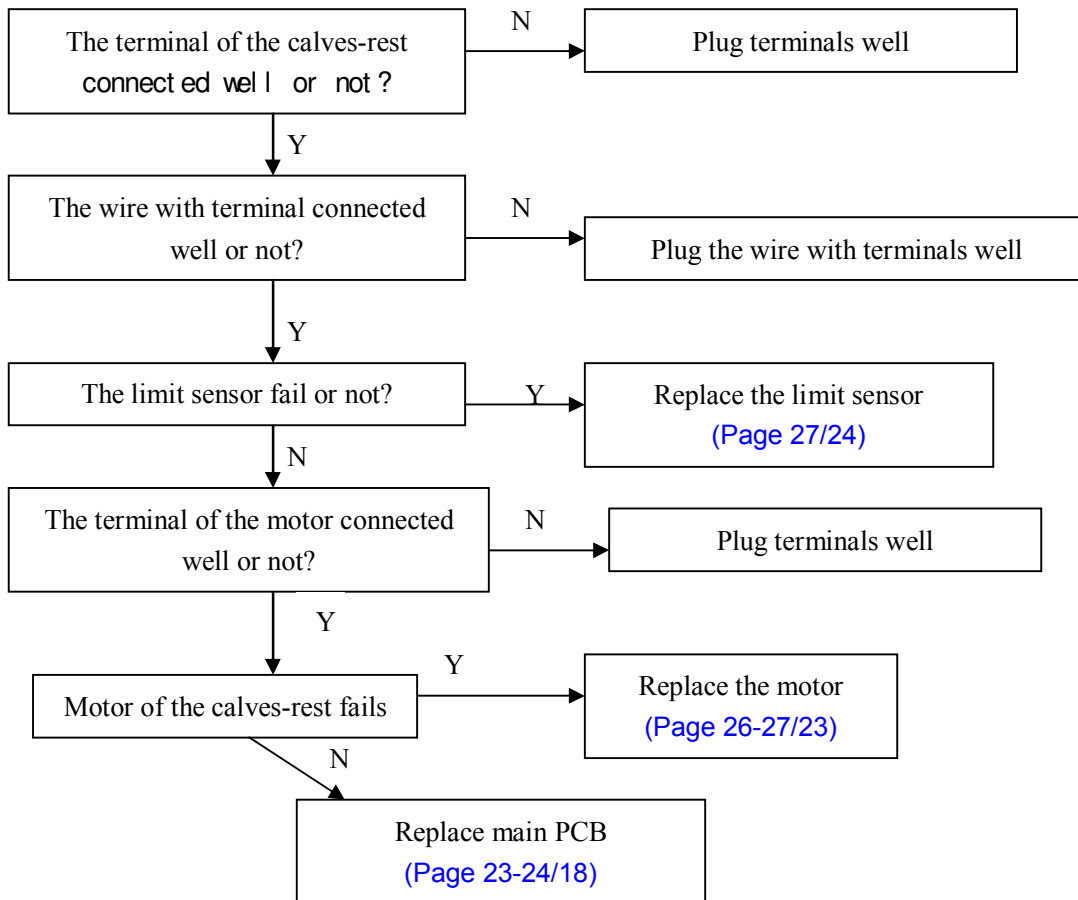

Common trouble about electric control and processing methods of OS4000 are mentioned above. It is for indication only.

VI. Maintenance of the back rest

1. Disassembly and replacement of back pad

- ① Find the zipper on the top of the back rest. Unzip it, then the back pad can be removed.
- ② There are two air hoses at the bottom of the back pad, pull out the connectors if a replacement needed.
- ③ There is a zipper at the bottom of the back pad. Unzip it and lift the sponge, then you can see the air bags there.
- ④ Pull out the connectors of the hoses, then you can replace the air bag(s) if needed.



The zipper on the top of the backrest



The hoses of the back pad



The zipper at the bottom of the backrest



Pull out the hoses

2. Disassembly and replacement of the backrest

If the complete backrest is broken and need to be replaced, please consult the steps as below.

- ① Find the "stopper" under the backrest and press it , then you can fold backrest on seat part
- ② Find the wire plugs and pull out them.

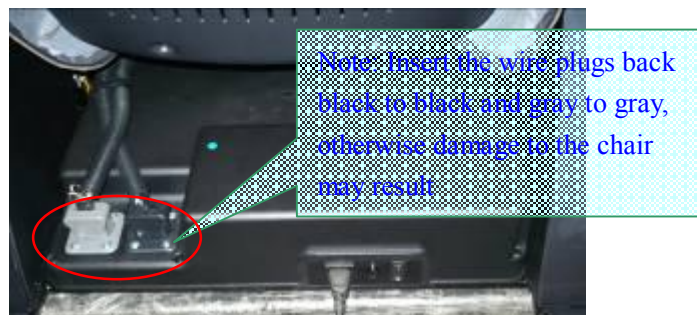

- ⑤ Disconnect the air hose of the backrest.
- ③ Unattach the connecting rod and the U stay fork of the reclining actuator with a flat head rivet, and pull out the split pin.
- ④ Lift the backrest at 90 degrees, then take it away from the chair.

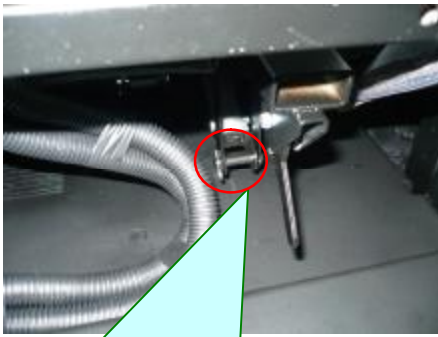

- A. Connecting rod (on the backrest)
- B. U stay fork of reclining actuator (on the seat)
- C. Flat head rivet
- D. Split pin

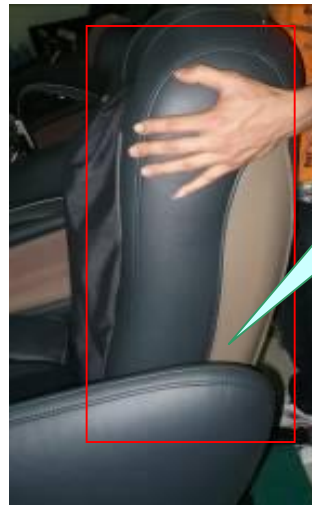

Lift the backrest at 90 degrees.

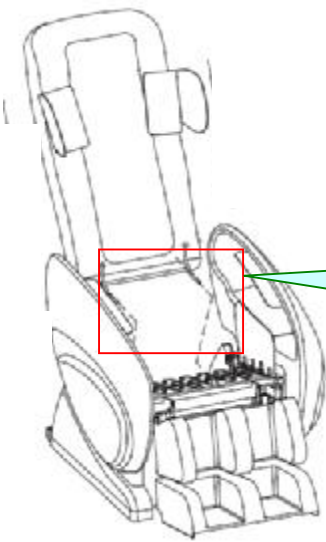

Disconnect the air hose of the backrest

3. Replacement of cloth of the front cover

- ① Unfasten the zipper of the back pad, and lay the back pad on the seat pad.
- ② You can find the zipper of the cloth at the left side. Unzip it and replace the cloth if needed.



Lay the back pad on the seat part



Unfasten the zipper zip

4. Disassembly and replacement of the rear cover

If you find any cracks on the rear cover, you can proceed as follow:

- ① Unfasten the zippers of the outer cloth of the rear cover.
- ② Find 4 pieces of screws fixing the rear cover.
- ③ Remove the screws with a plus screwdriver.
- ④ Then the rear cover can be removed.
- ⑤ If it's damaged, a new one should be replaced.

Attention: Take care not to damage the rear cover to avoid bad external appearance. Proceed in the reverse order of disassembly when assembling the rear cover.

Tool: a plus screwdriver

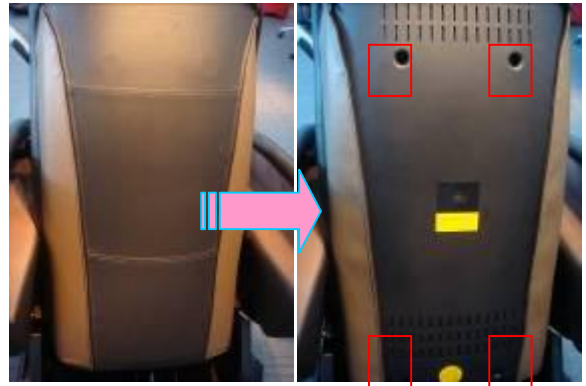

Screws securing the rear cover

5. Disassembly and replacement of the front cover of the back rest

If you find any cracks on the front cover or any rips in the inside cloth, you can proceed as follow:

- ① After disassemble the rear cover, you can find 6 pieces of screws fastening the front cover to back frame.
- ② Remove the screws with a plus screwdriver, then the front cover can be removed.
- ③ Proceed in the reverse order of above operation if replacement needed.

Attention: There are blocks between the front cover and back frame.

Tool: a plus screwdriver

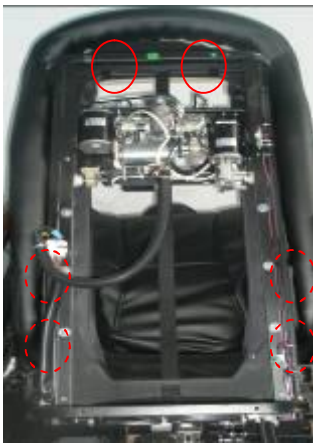

Screws fastening the front cover to the back frame (6 PCS)



6. Replacement of the kneading, tapping and rolling motors

Attention: The voltage of this massage chair is high and the motors are rotating in high speed, so make sure the power is OFF before disassembly. For safety, you should remove plug from outlet.

6.1 Kneading motor (DC -24V)

- ① Disassemble the rear cover of the back rest, and find the belt at top of the massage mechanism, then loosen the belt.
- ② Find the wire of kneading motor, and cut the cable ties tightening the wire with wire cutters.
- ③ Remove the close-end wire connectors covering the wires with



Kneading motor

nipper pliers, then disconnect the wires.

- ④ Find 4 pieces of screws fixing the kneading motor to the sheet-metal, remove the screws with a plus screwdriver.
- ⑤ Replace a new one if it does work.
- ⑥ Proceed in the reverse order of disassembly when replacing a new one.

Note: You should adjust the position of the small belt wheel, so the small and big belt wheels are in the same plane to prolong the life-span of the belt.



Cut the cable ties and remove close-end wire connector



Tools

6.2 Rolling motor (DC -24V)

- ① Disassemble the rear cover of the back rest, find the massage mechanism.
- ② Find the rail on the top of backrest and remove the screws to disassemble it.
- ③ Disassemble the massage mechanism from the chair. (refer to 7.2)
- ④ Remove rolling car take from rack rail, there are 2 ways to choose, but "a" is more convenient than "b".

- a) Make the rolling motor power on, then revolve it until the rolling car take from backrest.
- b) Use tools turn around axletree to revolve until the rolling car take from backrest.

- ⑤ Find 5 pieces of screws fixing the Rolling motor to the sheet-metal, remove the screws with a plus screwdriver.
- ⑥ Replace a new one if it does work.



Rolling motor



Remove the screws (2pcs)

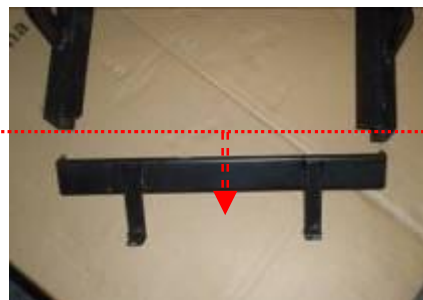

Turn around axletree to revolve until the rolling car take from backrest.



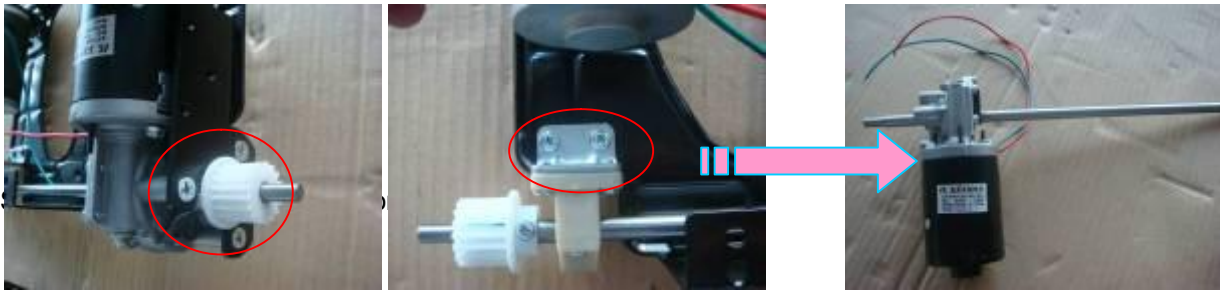

Screws (5pcs) securing the Rolling motor

6.3 Tapping motor (DC -24V):

- ① Disassemble the rear cover, then find the tapping motor.
- ② Cut the cable ties securing the wire on the sheet-metal of EMC.
- ③ Remove the close-end wire connectors of the tapping motor wires, then disconnect them.
- ④ Loosen the belt of tapping motor, then remove the screws securing the tapping motor.
- ⑤ Then the tapping motor can be removed and replaced.
- ⑥ Proceed in the reverse order of disassembly when assembly.



Tapping motor



Close-end wire connector of tapping motor

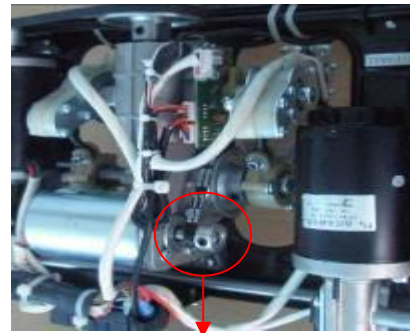

7. Maintenance of the massage mechanism

7.1 Replacement of the Width Inspection Board

Note: ① If the massage mechanism is just kneading but no tapping or rolling, or it doesn't work when power is on, and the main PCB is ok, in this we can think of that the Width Inspection Board fails.

② It's not necessary to disassemble the massage mechanism when replacing the Width Inspection Board, just disassemble the front and rear cover of the back rest.

- ① Disassemble the front and rear cover of the back rest as it is mentioned above.
- ② Pull out the terminal on the board and cut the cable ties fixing the wires.
- ③ Remove the screws securing the board, then a new one can be replaced.
- ④ Proceed in the reverse order of disassembly when assembly.

Tools: a plus screwdriver, wire cutters



1 terminals on the board

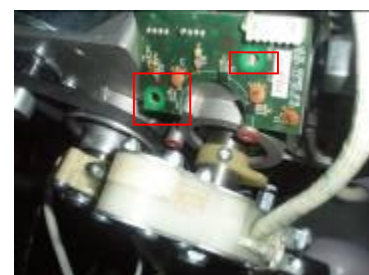

Screws(2pcs)securing the board

7.2 Disassembly and replacement of the massage mechanism

Note: If the swinging arms are broken or it is too noisy, you can try to do something to the massage mechanism. You should disassemble the rear cover and the cloth of the back rest.

- ① Disassemble the rear cover of back rest, remove the back pad, and disassemble the cloth of the back rest, cut all the cable ties tightening the wires.
- ② Remove the close-end wire connectors of tapping motor wires, then disconnect the wires.
- ③ Pull out the terminals of the Width Inspection Board, 3 PCS.
- ④ Take down the belt of tapping motor, then disassemble the tapping motor. Remove the screws securing the massage mechanism on the running frame and the screws securing nylon clamp which fixes wires.
- ⑤ Adjust the position of the massage mechanism and the width of the swinging arms, until the massage mechanism is taken off.

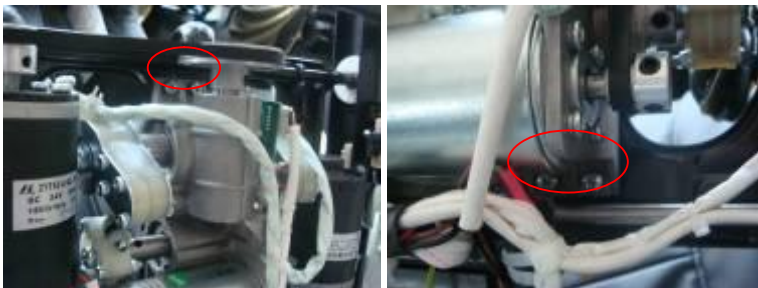

Screws securing the mechanism

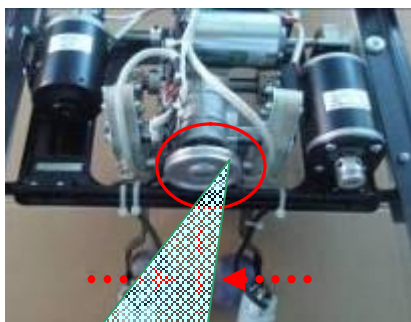

Adjust the position of the massage mechanism and the width of the swinging arms



Massage mechanism taken down

8. Replacement of up or down stroke photo-electricity assembly

- ① Disassemble the rear cover of the back rest.
- ② Pull out the terminal of the wire.
- ③ Remove the screws tightening the PCB of up or down stroke photo-electricity assembly to the sheet-metal with a plus screwdriver and nipper pliers.
- ④ Proceed in the reverse order of disassembly when replacement needed.

Tools: a plus screwdriver and nipper pliers

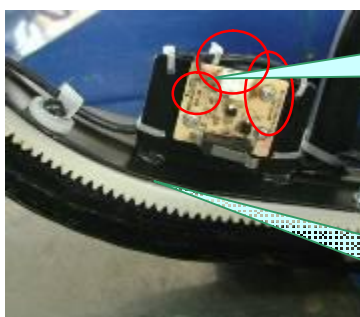

The terminal of the wire



Remove the screws (3pcs)



VII. Maintenance of the seat part

9. Replacement of the remote controller holder

- ① Pull out the remote controller from the holder.
- ② Remove the screw bolt tightening the holder.
- ③ Take away the holder from the support.
- ④ Install a new holder on the support.
- ⑤ Tighten the holder with the screw bolt.

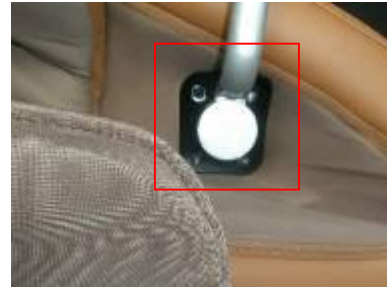

Screw bolt

10. Replacement of the remote controller

- ① Remove the screws (9pcs) on the back cover of the controller
- ② Disconnect the wire terminal of controller PCB; Then remove the screws(2pcs) on the PCB

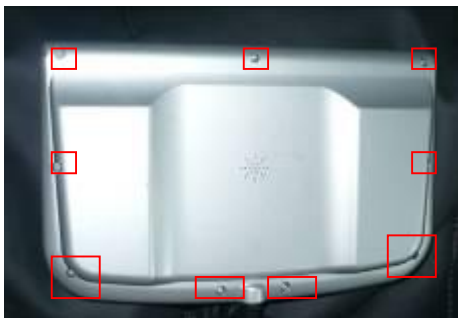

- ③ Then you can replace any parts of the controller including PCB, Front cover and Back cover.

11. Replacement of the remote controller wire

- ④ Along the controller wire and remove the screws(6pcs) fixing the "R" nip and disconnect wire terminal of controller.
- ⑤ Replace the new wire and fix it on the board, then connect the terminal of controller.



Screw bolt

12. Replacement of the front panel of seat part

- ① Turn on the power and raise the foot rest to the highest position.
- ② Operate the Zero-G 2 function to raise the seat-rest,
- ③ Remove the screws(12pcs) securing the front panel.
- ④ Then the front panel can be removed, replace it with a new one, and tighten it with screws.



Raise the foot rest to the highest position



Screws(12pcs) securing the front panel

13. Replacement of the side board

- ① Disassemble the backrest from the chair
- ② Use a cable tie to unfasten the seat pad from the chair by the zippers.
- ③ Remove the screws (4pcs) securing the side board.
- ④ Disconnect the air hose of the side cover.
- ⑤ Lift the side boards at 90 degrees, then disassemble it from the chair.
- ⑥ Proceed in the reverse order of disassembly when replacement needed. But please note that when you fix the side cover make sure the air hose is not pressed by the seat frame.



Zipper

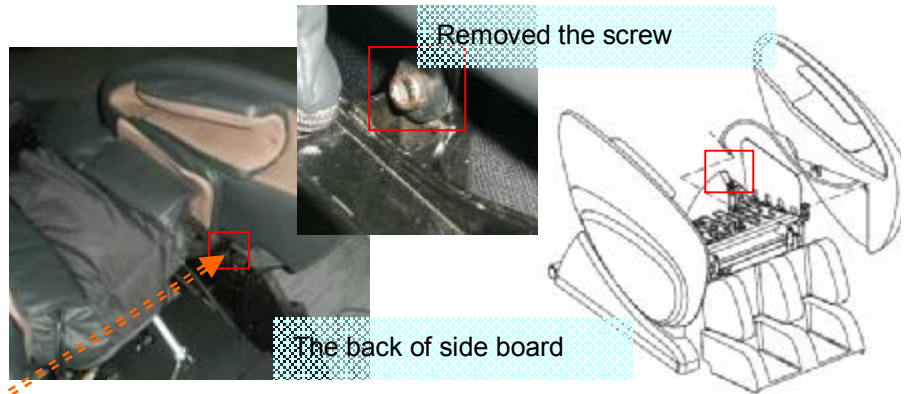

Removed the screw

The back of side board



Screws (2pcs) securing the front panel



Removed the screw

The front of side board



Last, lift up the side board

14. Replacement of the seat pad

- ① Disassemble the backrest from the chair
- ② Use a cable tie to unfasten the seat pad from the chair by the zippers.
- ③ Pull out the air hose Y- connector of the seat pad.
- ④ Find the connector of the vibration motor in the seat pad, cut the cable ties tightening the wire and connector, disconnect the connector.
- ⑤ Then the seat pad can be replaced.
- ⑥ Proceed in the reverse order of disassembly when assembly.

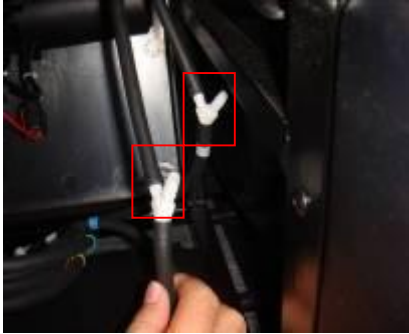

Air hose Y- connector



Cable ties tightening the wire and connector

15. Disassembly of the reclining actuator

- ① Disassemble the backrest from the chair, then find the reclining actuator
- ② Along the connecting wires of the reclining actuator to find the 2 connectors, then disconnect them.
- ③ Remove the upper part of the front boards on the right.
- ④ Then the reclining actuator can be disassembled.
- ⑤ Proceed in the reverse order of disassembly when assembly.

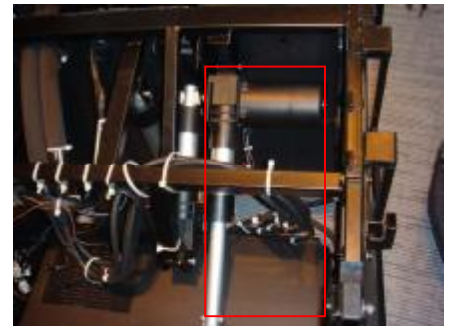

Reclining actuator

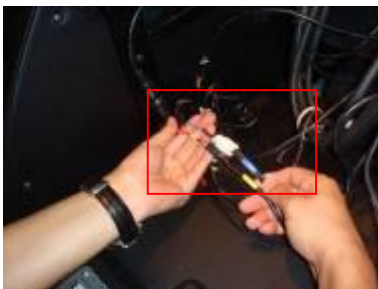

The connectors of the reclining actuator



Flat head rivet securing the reclining actuator on the U stay fork

16. Disassembly of the foot rest actuator

- ① Disassemble the backrest from the chair, then find the reclining actuator
- ② Along the connecting wires of the reclining actuator to find the 2 connectors, then disconnect them.
- ③ Raise the foot rest to the extreme position, then find each end of the actuator is fixing on the U stay fork. There are two plastic bush rings in the hole.

Attention: You must use the brace to support the footrest, avoid the footrest

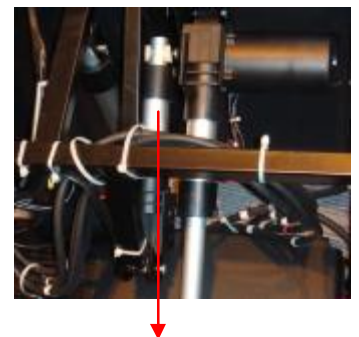

Footrest actuator

drop suddenly while pulling out plastic bush rings.

- ④ Pull out plastic bush rings, then the reclining actuator can be disassembled.
- ⑤ Proceed in the reverse order of disassembly when assembly.

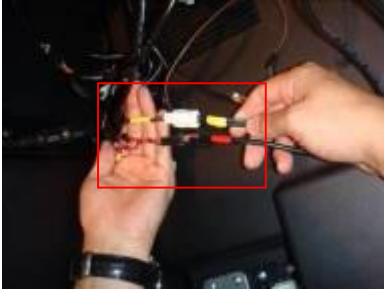

The connectors of the footrest actuator

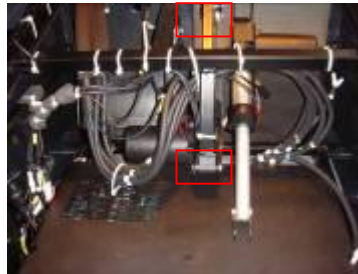

U stay forks

17 Disassembly of the zero gravity actuator

- ① Insert the power cord plug into an electrical outlet, turn the power switch to the "I" position for idle mode. Then operation the controller to raise the foot rest to the extreme position.
- ② Remove the bottom part of the front boards.

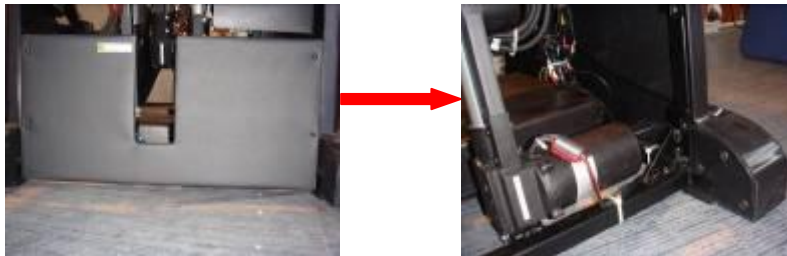

- ③ Along the connecting wires of the zero gravity actuator to find the 2 connectors, then disconnect them.

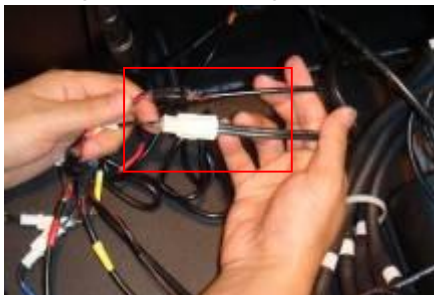

- ④ Find each end of the actuator is fixing on the U stay fork.
There are two plastic bush rings in the hole.
Attention: You must use the brace to support the footrest, avoid the footrest drop suddenly while pulling out plastic bush rings.
- ⑤ Pull out plastic bush rings, then the zero gravity actuator can be disassembled.
- ⑥ Proceed in the reverse order of disassembly when assembly.

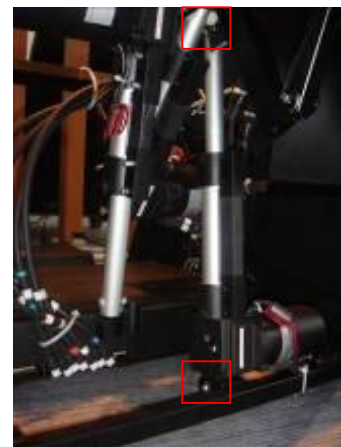

Footrest actuator

18 Replacement of the main PCB

- ① Turn off the power, then lay the back rest on the seat pad and pull out the terminals of the back rest.
- ② Remove the screws(2pcs) securing the box of the main PCB on the iron tubes.
- ③ If you just remove the upper cover of main PCB box only, just need to operate the Zero-G 2 function to raise the seat-rest, then remove the screws(9pcs) on the box to take down the up cover of the main PCB box

- ④ Pull out all the terminals on the main PCB, disconnect the PCB supports, then the main PCB can be removed.
- ⑤ Proceed in the reverse order of disassembly when assembly.

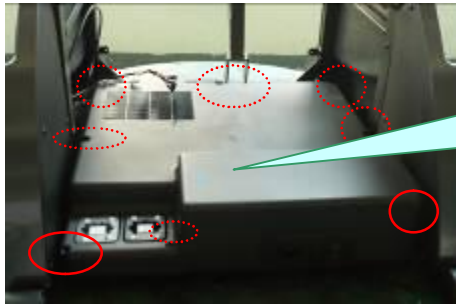

Remove the screws(9pcs) on the box to take down the up cover of the main PCB box

Main PCB

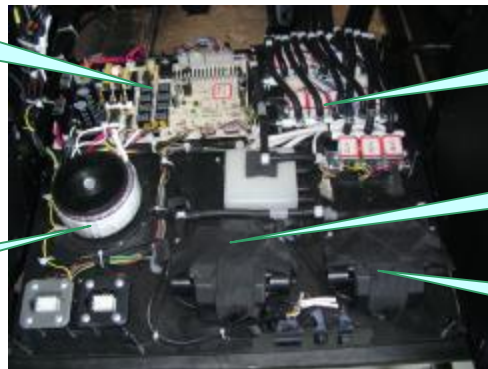

Air valves

Inflator pump1

transformer

Inflator pump2

Comment: You can replace the part(s) that may be damaged on the board referring to the picture above, which to remove the screws or connectors securing the damaged part(s).

19 Replacement of the inflator pump and the snuffle valves



Snuffle valves

Inflator pumps

- ① Turn off the power, then lay the back rest on the seat pad and pull out the terminals of the back rest.
- ② Remove the screws(2pcs) securing the box of the main PCB on the iron tubes.
- ③ Operate the Zero-G 2 function to raise the seat-rest, then remove the screws(9pcs) on the box to take down the up cover of the main PCB box
- ④ Pull out the terminals of inflator pump and snuffle valves. Pull out the air hose connectors
- ⑤ Pull out 4 pieces of the rubber posts with nipper pliers, then the inflator pump can be removed.
- ⑥ Remove the screws tightening the snuffle valves, then the snuffle valves can be replaced.
- ⑦ Proceed in the reverse order of disassembly when assembly.

20. Replacement of power supply fuse

② Find the fuse at the bottom of the seat part.

Turn the fuse holder in the counterclockwise direction with a finger nail or a minus screwdriver.

③ Take out the fuse from the fuse holder and replace with a new one.

④ Put in the holder and turn the fuse holder in the clockwise direction, then it will be fixed.



Fuse holder taken away

Attention:

① Make sure to use a glass tube fuse (the same type).

② Make sure to turn "OFF" the power supply and remove the power cord plug of the main unit from the receptacle.

21. Replacement of the caster wheel

① Remove the screws securing the rubber support.

② Pry the caster wheel with a minus screwdriver and the caster can be replaced.

③ Proceed in the reverse order of disassembly when assembly.



Screws securing the rubber support

IX. Maintenance of the foot rest

22. Replacement of the whole foot rest

- ① Turn on the power and raise the foot rest to the highest position. Then turn off the power.
- ② Remove the screws securing the front panel, take it away.
- ③ Find the air hose connectors of the foot rest, then disconnect them.

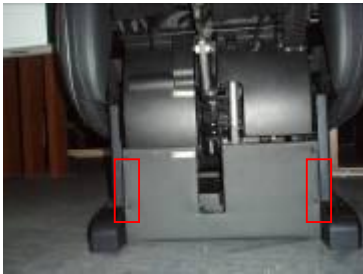

Screws securing the front panel



Air hose connectors of the foot rest

- ④ Pull out the connectors of the wires of foot rest.
- ⑤ Remove split pin, draw out flat head rivet securing the link rod of the foot rest.



Connectors of the wires of foot rest

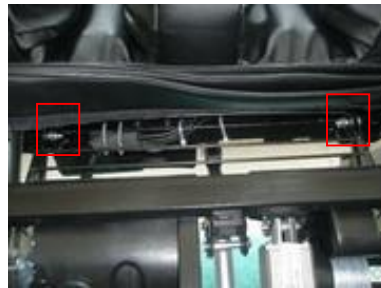

Screw bolts and nuts

- ⑥ Unfasten the zipper between the seat pad and foot rest, then remove the screw bolts and nuts fixing the foot rest on the seat part.
- ⑦ Proceed in the reverse order of disassembly when assembly.

23. Replacement of the footrest motor

- ① Remove split pin, draw out flat head rivet in the link rod, rotate the foot rest backward, then it will be locked by the side boards.
- ② Remove the screws fixing the cover of foot rest, then it can be taken away.
- ③ Remove the close-end wire connectors, loosen the belt and take it away.



Screws(9PCS) fixing the cover of footrest



Belt and close-end wire connector

- ④ Remove the screws fixing the foot rest motor, then it can be removed.
- ⑤ Remove the screw fixing the wheel of belt on the motor shaft, then take a new motor, and assemble the

wheel of belt on the shaft.

⑥ Proceed in the reverse order of disassembly when assembly.

Note: You should adjust the position of the wheel of belt, so the two wheels are in the same plane.

24. Replacement of the front and back sensors of foot rest

① Remove split pin, draw out flat head rivet in the link rod, rotate the foot rest backward, then it will be locked by the side boards.

② Remove the screws fixing the cover of foot rest, then it can be taken away.

③ Pull out the terminal of front or back sensor.

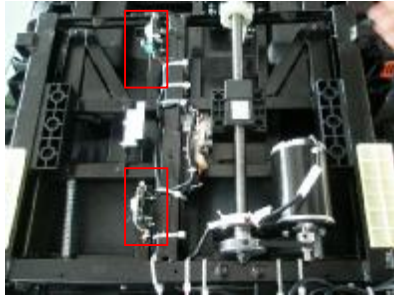

Front and back sensors



Sensor

④ Remove the screw bolts and nuts tightening the sensors on the sheet-metal with screwdriver and nipper pliers. There are nuts between the PCB and sheet-metal. Remove the nuts.

⑤ Take a new sensor, then assemble the screw bolts and nuts on the PCB, then fix it on the sheet-metal with nuts.

25. Replacement of connecting PCB of foot rest

① First the cover of foot rest should be removed.

② Pull out all the terminals of the connecting PCB, please remember the position of them.

③ Remove the screw bolts and nuts fixing the PCB on the sheet-metal, then it can be taken down.

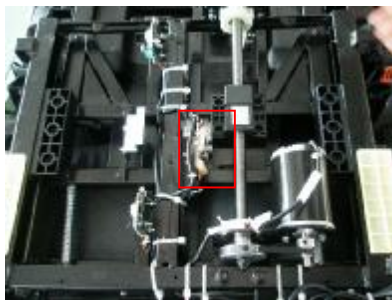

Connecting PCB

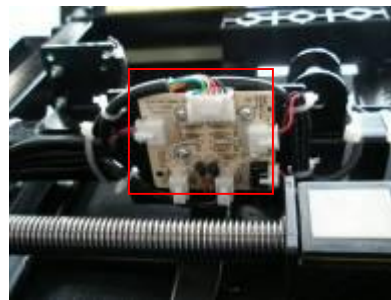

Terminals of connecting PCB

④ Remove the nuts fixing on the PCB.

⑤ Take a new PCB, then proceed in the reverse order of disassembly when assembly.

26. Replacement of touchdown sensor of foot rest

① After disassembling the cover of foot rest, you can find the touchdown sensor at the bottom of the foot rest.

② Pull out the terminal of the connecting PCB.

③ Remove the screw bolts and nuts fixing the PCB on the sheet-metal, then it can be taken down.



Touchdown sensor

- ④ Remove the nuts fixing on the PCB.
- ⑤ Take a new PCB, then proceed in the reverse order of disassembly when assembly.

27. Replacement of upper outer coating of foot rest

- ① First you should disassemble the whole foot rest, and the cover of foot rest should be removed.
- ② Rotate the belt wheel to extend the foot rest to the longest position. Remove the screws tightening the upper part of the foot rest.
- ③ Unzip the side zipper of the upper outer coating, then Remove the screws fixing the outer coating.

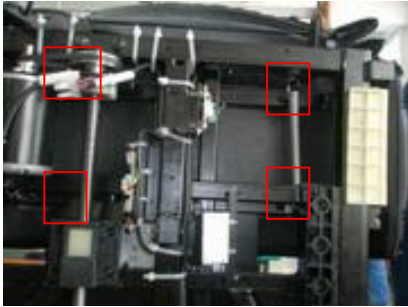

Screws tightening the upper part



Screws fixing the outer coating

- ④ Unfasten the zippers between the upper and lower part of the foot rest, then the outer coating can be remove.
- ⑤ Proceed in the reverse order of disassembly when assembly.

28. Replacement of lower outer coating of foot rest

- ① First you should disassemble the whole foot rest, and the cover of foot rest should be removed.
- ② Rotate the belt wheel to extend the foot rest to the longest position. Remove the screw bolts fixing two rubber supports at the bottom of the foot rest.
- ③ Unfasten the zipper at the bottom of the foot rest, then remove the screws fixing the PE board and take away the PE board.



Rubber supports

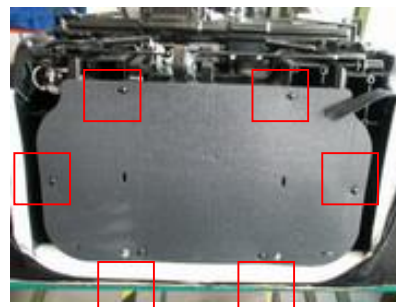

Screws fixing the PE board

- ④ Remove the nuts fixing the lower part of the foot rest.
- ⑤ Rotate the cover of the wheel castor, then it can be removed. Removed screw bolt fixing the caster wheel, then the castor can be removed.

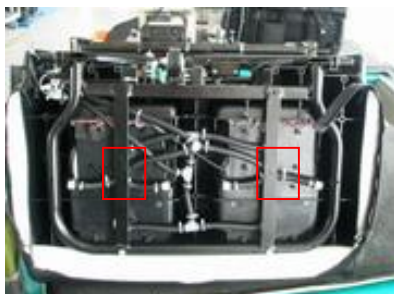

Nuts fixing the lower part



Caster wheel

- ⑥ Remove the screws fixing the lower part of the foot rest, then the outer coating can be removed.
- ⑦ Proceed in the reverse order of disassembly when assembly.



Castor taken down



Screws fixing the lower part